

Alignment for Optics & Silicon Photonics

FAST MULTI-CHANNEL PHOTONIC ALIGNMENT SYSTEM

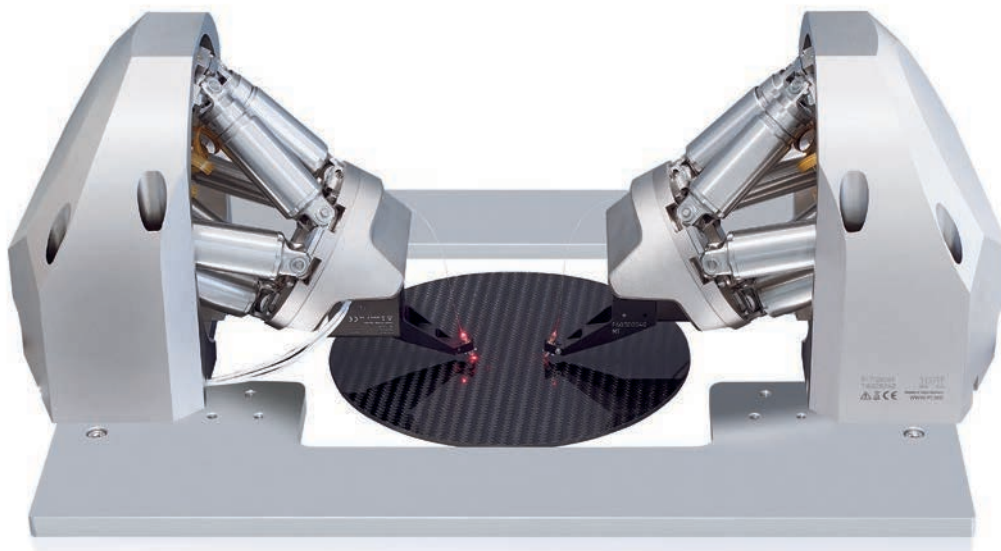

Silicon Photonics (SiP)

The rapid advent of Silicon Photonics offers promise for bandwidth, efficiency and extensibility, and it presents many challenges for test and packaging processes. Key among these is the need to align fiber optic devices to optimize optical throughput before testing or packaging can begin. Simple economics necessitates fast throughput in this unpredictable nanoscale-accurate step. Silicon photonics devices often need alignments in multiple degrees of freedom across more than one input or output coupling, and these can interact, presenting moving targets.



PROBING

Sometimes, getting exactly the right coupling can be tricky and time-consuming. Clearly, manual approaches are not scalable over the volume demands SiP devices are enjoying. Even automated solutions can require lengthy iterative loops that kill test and packaging economics.

PI's alignment automation options provide exacting optimization using a deep toolkit of firmware-based algorithms. PI's unique, fully parallel technology can optimize multiple degrees of freedom, multiple inputs and outputs across multiple channels, or even multiple devices all at once. PI hexapod-based solutions offer a freely selectable pivot point, so you can optimize by rotating about a beam waist, focal point or optical axis for further efficiencies.

CHIP TEST

PI can make this a quick process, ensuring against the wasteful packaging of product that acquires damage during multiple packaging steps. Custom, embeddable configurations are welcome.

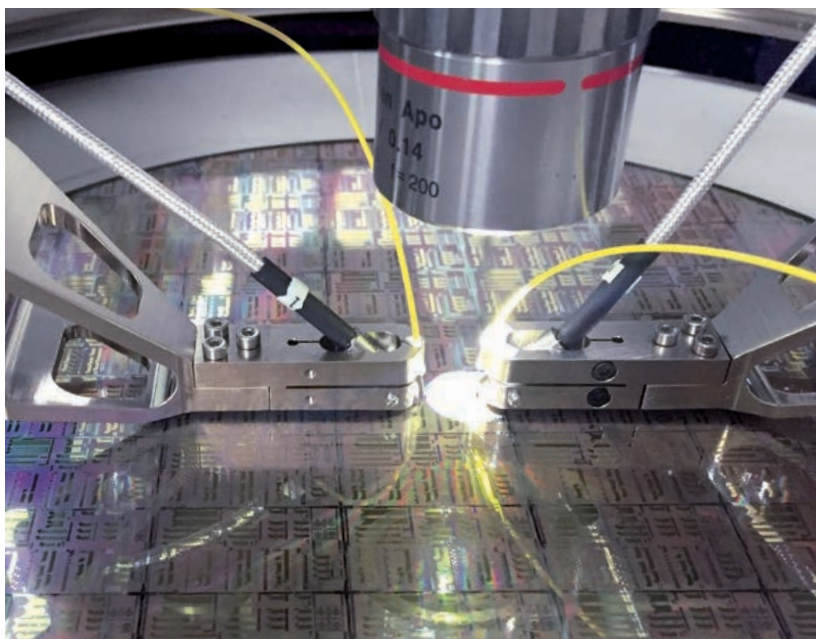

WAFER TEST

On-wafer photonic device testing is essential to ensure against faulty devices proceeding through the costly packaging process. Today's silicon photonics devices are more complex than ever, with multiple inputs and outputs that often interact, multiple channels, and alignments that must be optimized across multiple degrees of freedom in order for tests to proceed.

Cascade Microtech's pioneering CM300 photonics-enabled engineering wafer prober integrates PI's Fast Multi-Channel Photonics Alignment systems for high throughput, wafer-safe, nano-precision optical probing of on-wafer Silicon Photonics devices. Photo courtesy Cascade Microtech div. of Formfactor, Inc.

Packaging

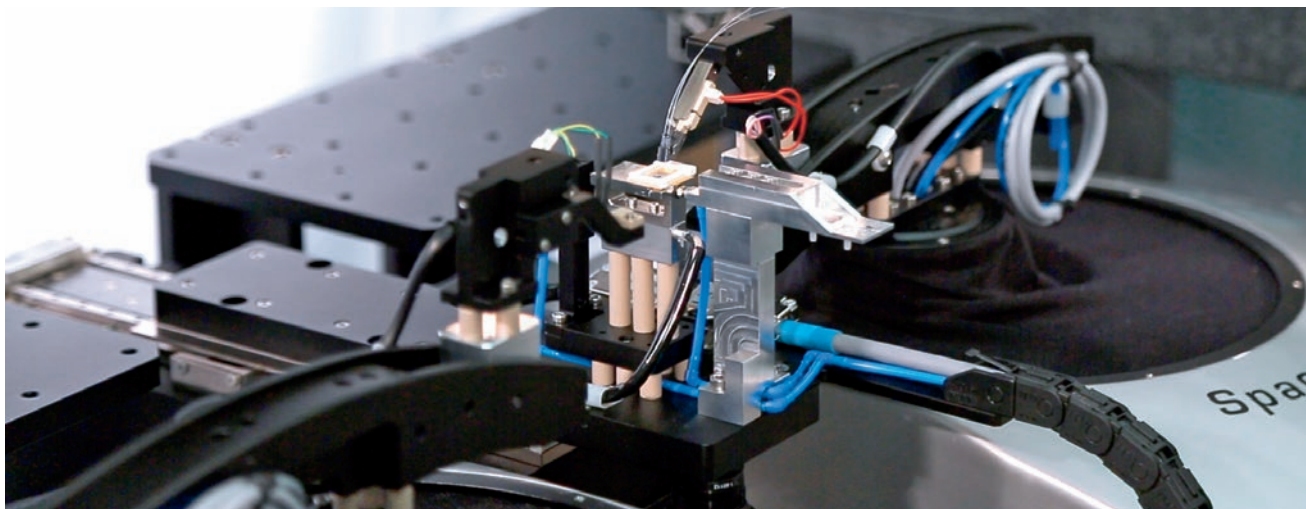

PI's deep industrial alignment toolkit includes all you need to address your test and production needs, including the world's most comprehensive line of photonics-focused mechanisms and controls. For example, make quick work of the multichannel optimizations; perform parallel optimization of multiple elements; quickly optimize in all degrees of freedom— all key capabilities for today's complex and tightly-packed photonic devices! This optimization can be continuous, tracking minute dimensional changes during burn-in and compensating for curing stresses and other drift processes.

ARRAY DEVICE ALIGNMENT

Array devices and others with angular optimization formerly required time-consuming, sequential optimizations. For example, theta-Z alignments could only be performed stepwise, with an XY optimization in between steps. This rendered the overall alignment very time-consuming. And time is money, especially today. PI addresses this through parallelism, a unique new capability. In the theta-Z example just mentioned, the lengthy loop of stepwise iterations in XY, then theta-Z, then XY, and so on, is replaced with a one-step optimization of both at the same time. Additional angular optimizations and (in the case of a waisted coupling) Z optimization can be performed at the same time too, allowing a one-step global optimization, and tracking too.

The resulting, typically 1-2 order of magnitude improvement in test and packaging throughput has a profound impact on process economics.

PI products come standard with a wealth of analog interfaces for connection to one or more PI optical power meters or other high-speed optical metrology instruments and sensors, including embedded sensors. Additional analog resources can be specified as needed. This means array devices can be optimized by aligning the two outermost elements or by balancing the coupling of multiple additional channels. Either way, alignment is as fast and accurate as you would expect from PI, the world leader in NanoAutomation®.

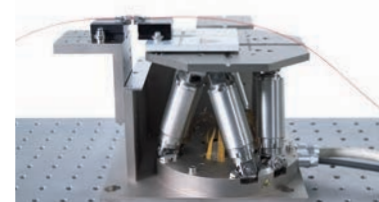

Basics of PI's Unique Fast Multi-Channel Photonic Alignment (FMPA)

COMPREHENSIVE SOFTWARE STACK ENABLES EASY INTEGRATION AND USE

Start with quick set-up, exploration and ease of use with PIMikroMove. Proceed to productivity with useful, open-source graphical applications examples that include scriptability for fast construction of test executives using virtually any language. Rapidly construct custom applications using PI libraries and samples for popular platforms including C++, C#, MATLAB, Python and LabVIEW on Windows, Linux and macOS. 100% ASCII communications ensures compatibility with legacy fab computers.

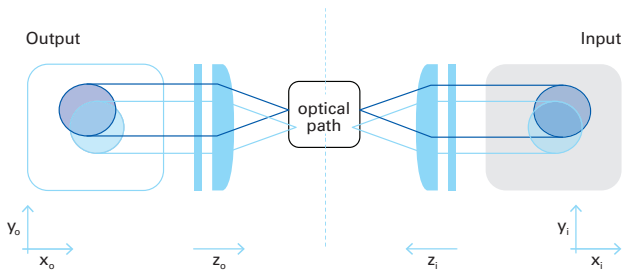

Testing and packaging today's photonic devices can be a multi-degree-of-freedom challenge and a moving target. PI's industrial-class solutions help you make it a fast, reproducible, one-step process.

■ misaligned optical path
■ ideal optical path

GROUNDBREAKING BUILT-IN ROUTINES FOR FASTEST PEAK FINDING

Built-in routines enable extremely high alignment speed. The algorithms for first light, area scan, and gradient scan routines are extraordinarily fast and reliable for all kind of couplings. They offer process time of less than 1 second for aligning input and output simultaneously. PI algorithms even include automatic modeling of scan data to accurately localize the optimum even in fast, coarse scans. This includes the ability to rapidly localize the centroid of top-hat couplings – another PI world exclusive.

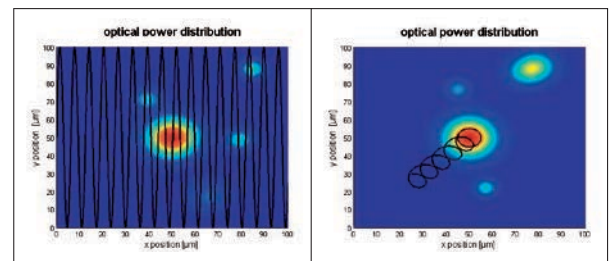

Automated Alignment is the Key to High Throughput and Outstanding Quality

The key component of the alignment systems is PI's Nano-Cube®, a highly dynamic, closed-loop XYZ piezo scanner. It is so compact yet yields 100 x 100 x 100 µm travel with nanoscale repeatability and extreme speed. With a completely wear-free working principle, it makes even the most complicated coupling optimizations possible in typically a few hundred milliseconds. The integrated optical encoder offers the highest bandwidth and resolution for this high-dynamic application. Closed-loop operation helps ensure device safety and process repeatability.

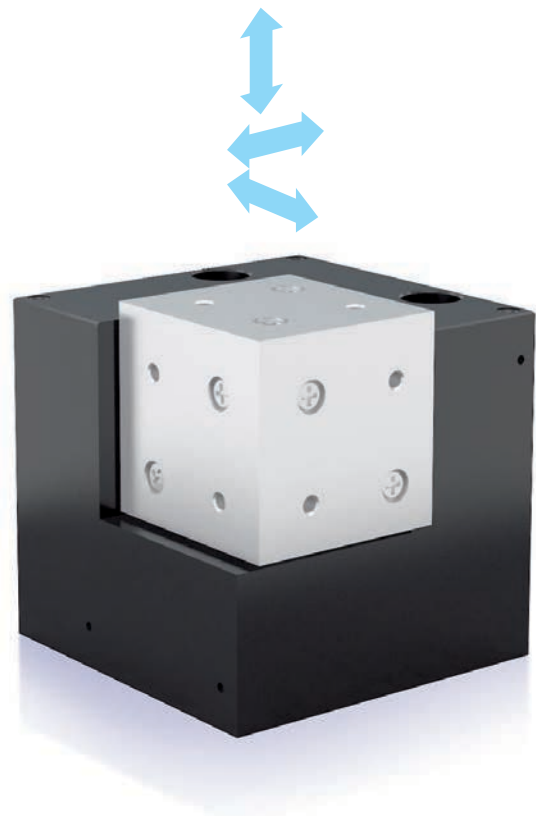

PI hexapods offer all 6 degrees of freedom, namely 3 linear and 3 rotational axes, combined into parallel kinematics. A further advantage of the hexapod is the user-definable pivot point that enables rotation directly around the fiber tip and if required, also allows any other point of rotation.

Either stacked linear axes or hexapods can be used for positioning or scanning larger areas. In the case of stacked systems, a lot of value was placed on robustness and stiffness. All linear axes are equipped with position sensors and are connected to each other by very stiff brackets. High-quality components and a solid design guarantee reliability and a long lifetime.



First Light Scan

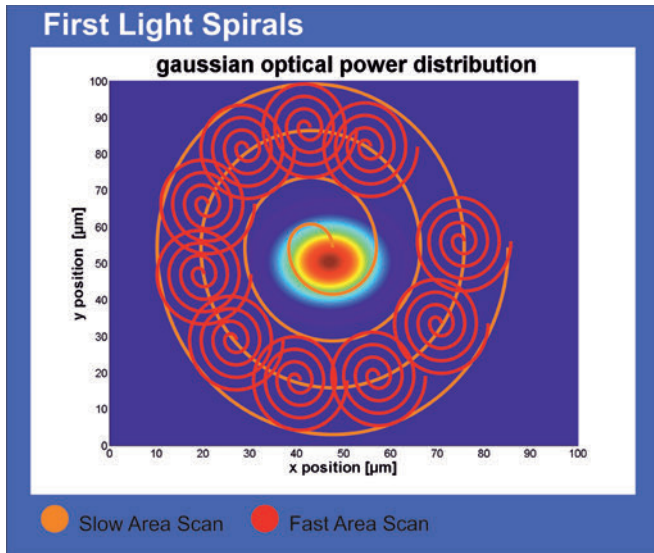

In order to determine the global maximum of a signal, it is necessary to make an intensity signal available to the controller that can be optimized. The built-in firmware algorithms provide all convenient and fast searching for 'first light'. To ensure extremely fast success for first light searching, it is possible to combine several area scan routines for this scan, which can be performed simultaneously.

This can be performed quickly and reliably even for double-sided tasks, where both sides need to be coupled at the same time; the firmware-based algorithms run fully automatically and simultaneously until the predefined threshold value has been reached or the entire area has been scanned.

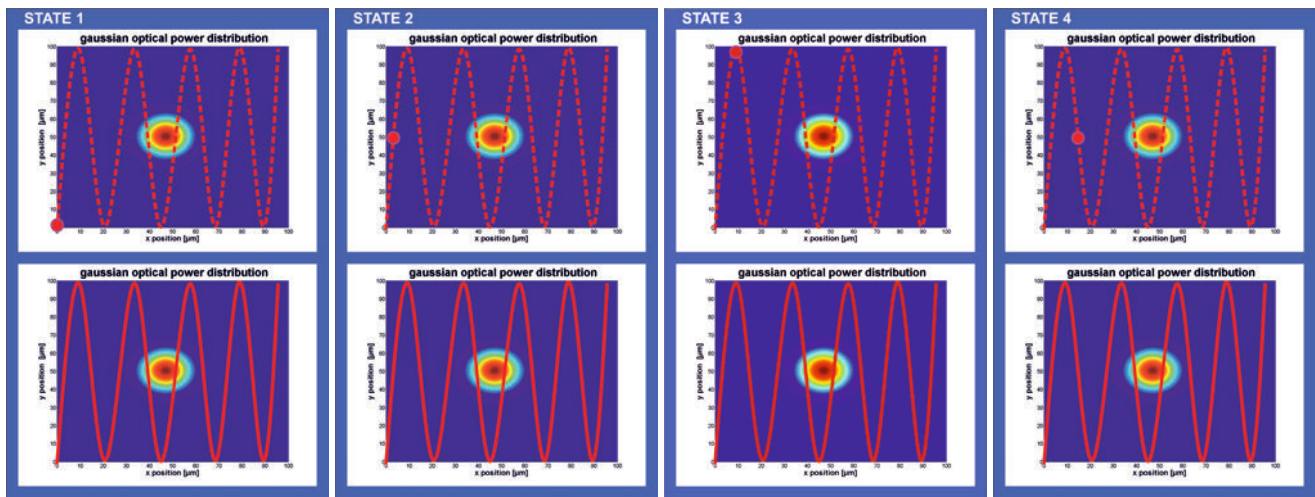

All axes, irrespective of whether they are coarse or fine axes, can be used and configured according to their dynamics. For example, the transmitter side can perform highly dynamic area scans, during which, the receiver side moves slowly but continuously. Therefore, the entire transmitter side is scanned for each and every position on the receiver side. It is also possible to set whether scanning stops as soon as the defined threshold value has been reached or whether the entire area of both sides should be examined.

Area Scan Routines

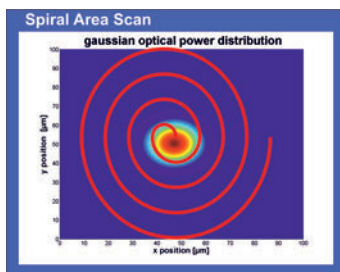
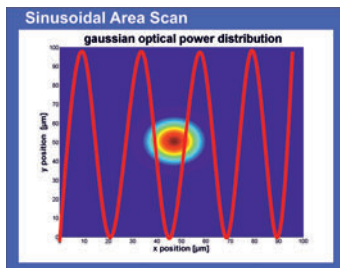

The FMPA system offers 3 different routines for an area scan. The spiral scan with constant angular velocity, the spiral scan with constant path velocity, and the sinusoidal area scan. All routines can be configured individually and therefore optimized for the respective application case. Several scan routines can also be started simultaneously with a single command. It is possible to calculate the approximate maximum using a Gauss function or by determining the centroid.

In the case of the sinusoidal scan routine the defined surface is scanned continuously without strong acceleration or deceleration phases. Surface, starting point, line distance, and success criteria can be defined by the user.

In the case of the spiral scan routine, a defined area is scanned helically, whereby either a constant angle or a constant path velocity is maintained. The advantage of spiral scanning at a constant frequency is the ability to avoid system resonance. This ensures successful scanning. The advantage of spiral scanning at a constant path velocity is the ability to reduce the scanning duration in the case of lower system dynamics. Application-specific configuration of the routine is also possible here.

Gradient Search Routines

Ground-breaking results can be achieved with the unique implementation of this algorithm. If the light signal is present, this gradient search makes it possible to find the signal maximum in less than 1 second even in the case of double-sided tasks. It is also possible to run several searches at the same time and therefore optimize the signal simultaneously in several degrees of freedom. The routine allows excellent „tracking“ and therefore it is possible to compensate any drift effects. Several parameters are also available here for optimizing the search for the respective application case.

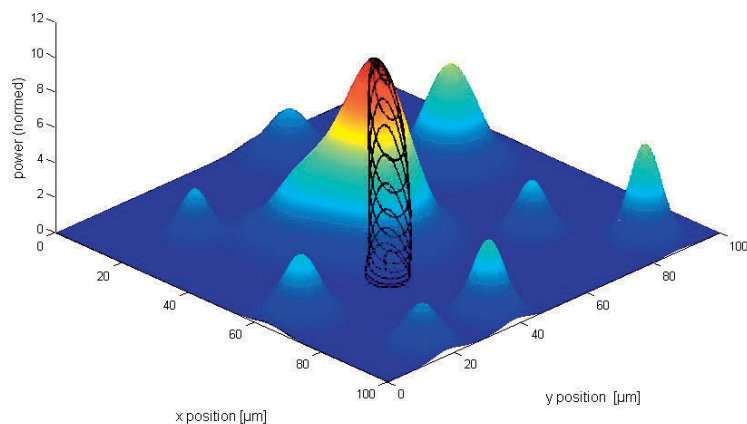

PIMikroMove

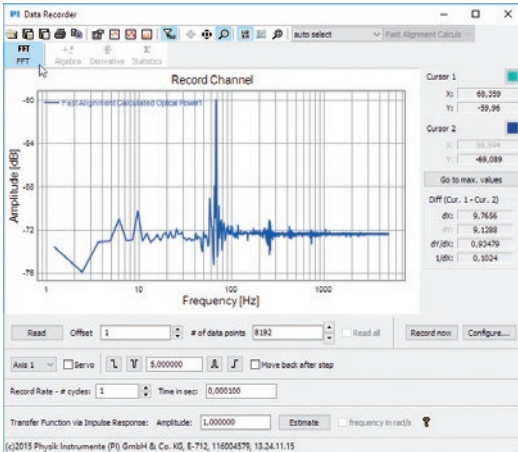

PIMikroMove gives you the option to control axes, perform (manual) tuning as well as record data from the controller in real time, display the data graphically and also analyze the data. Furthermore, it is also possible to access all controller algorithms and parametrize them conveniently; this also includes the fast alignment routines.

A live display of the analog inputs (incl. floating chart) as well as a 3-D view of optical distribution of the scanned area is particularly interesting for alignment tasks. Of course, it is also possible to export the data (.csv). Various tools are available for realtime data analysis, triggering, configuration, and much more.

PIMikroMove does not only offer the possibility of analyzing the dynamic properties of the PI axes, but can even perform an evaluation of the overall system with the help of an FFT analysis of the optical signal.

Controller	Stage	Target Value	Open-Loop Target Value	Step size	Current Value/Position	Control Value	Current Motor Out	HALT State	Velocity
SPI E-712 (172.16.50.74)	P-6180001	47,216 um	39,016	0,300 um	46,029 um			HALT on target	200000,000
SPI E-712 (172.16.50.74)	P-6180001	47,518 um	-8,915	0,200 um	46,945 um			HALT on target	2000000000000000,000
SPI E-712 (172.16.50.74)	P-6180001	50,001 um	41,888	0,300 um	50,016 um			HALT on target	9999997950,000
SPI E-712 (172.16.50.74)	P-6180001	53,486 um	-42,872	0,300 um	50,659 um			HALT on target	200000,000
SPI E-712 (172.16.50.74)	P-6180001	49,050 um	51,513	0,300 um	48,812 um			HALT on target	200000,000
SPI E-712 (172.16.50.74)	P-6180001	46,962 um	57,700	0,300 um	46,986 um			HALT on target	200000,000
X Hexapod SENDER (172.16.50.94)	H-8130044_AXIS_X	3,9415 mm		0,0200 mm	3,9415 mm			HALT on target	
Y Hexapod SENDER (172.16.50.94)	H-8130044_AXIS_Y	4,4400 mm		0,0200 mm	4,4400 mm			HALT on target	
Z Hexapod SENDER (172.16.50.94)	H-8130044_AXIS_Z	0,9889 mm		0,0200 mm	0,9889 mm			HALT on target	
M Hexapod SENDER (172.16.50.94)	H-8130044_AXIS_M	-0,0000 deg		0,0200 deg	-0,0000 deg			HALT on target	
N Hexapod SENDER (172.16.50.94)	H-8130044_AXIS_N	0,0000 deg		0,0200 deg	-0,0000 deg			HALT on target	
W Hexapod SENDER (172.16.50.94)	H-8130044_AXIS_W	-0,0000 deg		0,0200 deg	-0,0000 deg			HALT on target	
X Hexapod RECEIVER (172.16.50.97)	H-8130044_AXIS_X	2,6199 mm		0,0200 mm	2,6199 mm			HALT on target	
Y Hexapod RECEIVER (172.16.50.97)	H-8130044_AXIS_Y	4,1843 mm		0,0200 mm	4,1843 mm			HALT on target	
Z Hexapod RECEIVER (172.16.50.97)	H-8130044_AXIS_Z	1,1200 mm		0,0200 mm	1,1200 mm			HALT on target	
M Hexapod RECEIVER (172.16.50.97)	H-8130044_AXIS_M	-0,0000 deg		0,0200 deg	-0,0000 deg			HALT on target	
N Hexapod RECEIVER (172.16.50.97)	H-8130044_AXIS_N	0,0000 deg		0,0200 deg	0,0000 deg			HALT on target	

PIMikroMove application for Windows provides quick access to motion & scanning across all PI products regardless of drive technology, controller type, no. of axes etc. Includes software-based scan & align routines which work with all available PI motion controllers and access to all available firmware-based fast alignment algorithms.

Available Programming Languages

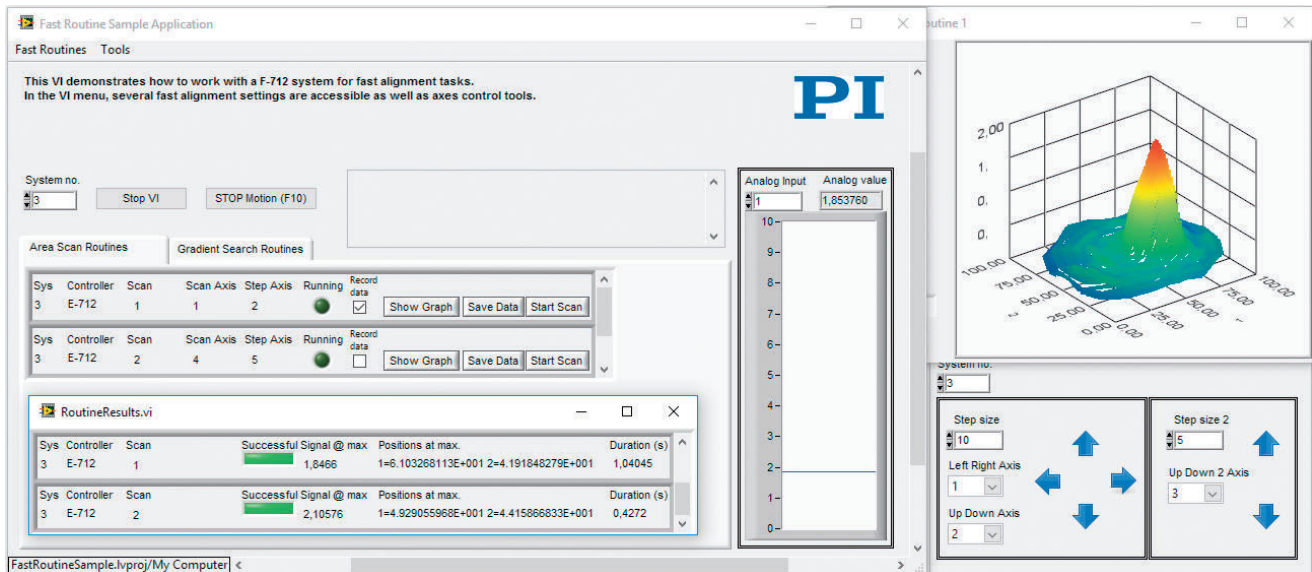

Ready-to-use LabVIEW sample application that provides fast access to controller-based alignment routines as well as visualization and system analysis.

User-friendly, platform-independent application development libraries and sample applications for easy, fast, and flexible implementation

- Libraries for C++, C#, VB.net, etc.
- Python
- LabVIEW
- MatLab

Available for Windows, Linux and OS X deployment. Universal Command Set (GCS) simplifies commissioning and programming. Supports PI controllers' built-in, ultrafast, and vibration-free scan/align algorithms. It is also possible to access the entire command set, including the fast alignment routines in the controller, in order to parameterize and execute them. This makes it possible for customers to integrate PI controllers into their own software solutions quickly and easily.

```

1  #!/usr/bin/python
2  #-*- coding: utf-8 -*-
3  """This example shows how to define and run area and gradient scan routines."""
4
5  from time import sleep
6
7  from pipython import GCSDevice
8
9  CONTROLLERNAME = 'E-712'
10
11  AREASCAN = 1 # name of area scan routine
12  GRADIENTSCAN = 3 # name of gradient scan routine
13
14  RESULTIDS = {
15      1: 'successful bit',
16      2: 'signal level at maximum',
17      3: 'position of maximum signal'
18  }
19
20
21  def main():
22      """Connect controller and start scans."""
23      with GCSDevice(CONTROLLERNAME) as pdevice:
24          pdevice.ConnectRS232(comport=1, baudrate=115200)
25          # pdevice.ConnectUSB(serialnum='123456789')
26          # pdevice.ConnectTCPIP(ipaddress='192.168.178.42')
27          print('connected: {}'.format(pdevice.qIDN().strip()))
28          runscan(pdevice)
29
30
31  def runscan(pdevice):
32      """Define gradient and area scan routines and start them.
33      @type pdevice : pipython.gcscommands.GCSCommands
34      """

```

Python sample code

Fast Multi-Channel Photonic Alignment System

Stacked Multi-Axis System for Aligning Fibers and Optical Components



F-712.MA1 / F-712.MA2

- Integrated scan routines for fiber optic alignment
- Ideal for applications in silicon photonics
- Extensive software package
- Direct detection of the optical signal
- Position sensors for high accuracy and operational reliability
- Automatic alignment of several fibers in <1 s



Fast and high-precision drives

The basis of the optical alignment system is a very stiff XYZ set-up consisting of three motorized linear stages and a P-616 NanoCube® nanopositioner. The low overall height simplifies integration in limited installation space. The motorized drives make longer travel ranges possible and at the same time, the NanoCube® nanopositioner ensures fast scanning motion and dynamic compensation of drift effects. Flexure guides and all-ceramic insulated PICMA® actuators guarantee a long lifetime. Because all drives are equipped with position sensors, it is possible for example, to reliably prevent collisions with expensive silicon wafers.

High-performance scan routines

The sophisticated scan routines are integrated directly into the controller. The performance is improved considerably and integration simplified. The system can manage all tasks in the field of fiber alignment. For example, double-sided systems allow simultaneous alignment of the transmitter and receiver.

Extensive software package

The software package supplied in the scope of delivery allows integration of the system into virtually any environment. All common operating systems such as Windows, Linux, and OS X as well as a large number of common programming languages including MATLAB and LabVIEW are supported. Thanks to sophisticated program examples and the use of software tools such as PIMikroMove, the time between starting integrating and productive operation is shortened considerably.

High-resolution analog input

The controller receives the optical intensity signal directly via a high-resolution analog input. Complex set-ups with cameras are not necessary. Various distribution functions are available for determining the maximum intensity.

Fields of application

Alignment of optical components, automatic wafer tests, assembling technology in silicon photonics.

Preliminary data	F-712.MA1 / F-712.MA2	Unit
Motion and positioning		
Rough positioning		
Active axes	X, Y, Z	
Travel range in X, Y, Z	25, 25, 25	mm
Minimum incremental motion	3	µm
Max. velocity	20	mm/s
Sensor type	Rotary encoder	
Guiding	Crossed roller guides	
Drive type	DC motor	
Fine positioning		
Active axes	X, Y, Z	
Closed-loop travel in X, Y, Z	100	µm
Min. incremental motion, open-loop	0.3	nm
Min. incremental motion, closed-loop	2.5	nm
Linearity error, for the entire travel range**	2	%
Repeatability (bidirectional) 10 % travel range	2	nm
Sensor type	Incremental	
Drive type	PICMA®	
Alignment		
Alignment time area scan 100 µm x 100 µm (max. deviation of peak intensity 0.02 dB)***	<0.5 / <1	s
Alignment time gradient search, randomized with ±5 µm (repeatability <0.01 dB)***	<0.5 / <1	s
Miscellaneous		
Operating temperature range, mechanics	-20 to 65	°C
Operating temperature range, controller	5 to 40	°C
Cable length	3	m
Requirements for the photometer used		
Output signal	Analog output, ideally converted from linear to logarithmic	
Output voltage range, max.	-5 to 5	V
Bandwidth, min.	1	kHz
Noise level, max.	-60	dBm

Technical data specified at 20±3 °C.

* Without polynomial linearization

** Attainment of the global maximum after first light has been found

Ask about custom designs!

Fast Multi-Channel Photonic Alignment System

System with 6 Degrees of Freedom for Aligning Fibers and Optical Components

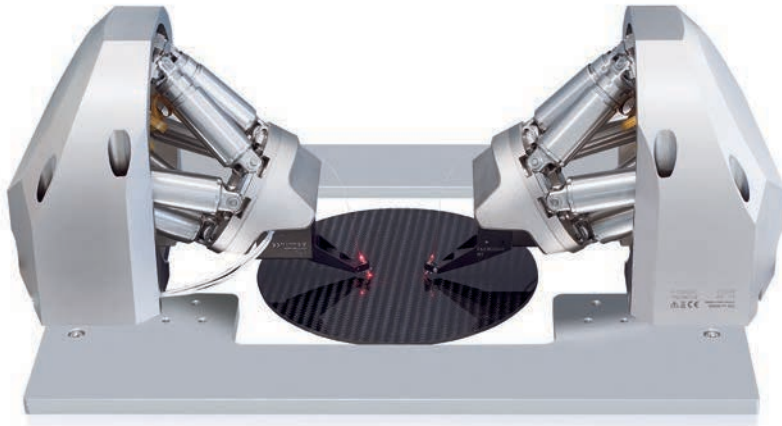

F-712.HA1 / F-712.HA2

- Integrated scan routines for fiber optic alignment
- Ideal for applications in silicon photonics
- Extensive software package
- Direct detection of the optical signal
- Position sensors for high accuracy and operational reliability
- Automatic alignment of several fibers in <1 s

Fast and high-precision drives

The basis of the fiber alignment system is a very stiff set-up consisting of the H-811 hexapod and P-616 NanoCube® nanopositioner. The parallel-kinematic design for motion in six degrees of freedom ensures high system stiffness. The motorized drives make longer travel ranges possible and at the same time, the NanoCube® nanopositioner ensures fast scanning motion and dynamic compensation of drift effects. Flexure guides and all-ceramic insulated PICMA® actuators guarantee a long lifetime. Because all drives are equipped with position sensors, it is possible for example, to reliably prevent collisions with expensive silicon wafers.

High-performance scan routines

The sophisticated scan routines are integrated directly into the controller. The performance is improved considerably and integration simplified. The system can manage all tasks in the field of fiber alignment. For example, double-sided systems allow simultaneous alignment of the transmitter and receiver.



Extensive software package

The software package supplied in the scope of delivery allows integration of the system into virtually any environment. All common operating systems such as Windows, Linux, and OS X as well as a large number of common programming languages including MATLAB and LabVIEW are supported. Thanks to sophisticated program examples and the use of software tools such as PIMikroMove, the time between starting integrating and productive operation is shortened considerably.

High-resolution analog input

The controller receives the optical intensity signal directly via a high-resolution analog input. Complex set-ups with cameras are not necessary. Various distribution functions are available for determining the maximum intensity.

Fields of application

Alignment of optical components, automatic wafer tests, assembling technology in silicon photonics.



C-887

- Hexapod controller using vector algorithms, virtual pivot point
- Commanding in Cartesian coordinates
- Changes of the reference system with a simple command
- TCP/IP and optional analog interfaces, motion stop

Preliminary data	F-712.HA1 / F-712.HA2	Unit
Motion and positioning		
Rough positioning		
Active axes	X, Y, Z, θ_x , θ_y , θ_z	
Travel range in X, Y, Z	± 6.5 , ± 16 , $\pm 8.5^*$	mm
Travel range in θ_x , θ_y , θ_z	± 14.5 , ± 10 , $\pm 10^*$	°
Minimum incremental motion	0.1	μm
Max. velocity	10	mm/s
Sensor type	Rotary encoder	
Guiding	–	
Drive type	Brushless DC motor	
Fine positioning		
Active axes	X, Y, Z	
Closed-loop travel in X, Y, Z	100	μm
Min. incremental motion, open-loop	0.3	nm
Min. incremental motion, closed-loop	2.5	nm
Linearity error, for the entire travel range**	2	%
Repeatability (bidirectional) 10 % travel range	2	nm
Sensor type	Incremental	
Drive type	PICMA®	
Alignment		
Alignment time area scan 100 μm x 100 μm (max. deviation of peak intensity 0.02 dB)**	<0.5 / <1	s
Alignment time gradient search, randomized with $\pm 5 \mu\text{m}$ (repeatability <0.01 dB)**	<0.5 / <1	s
Miscellaneous		
Operating temperature range, mechanics	0 to 50	°C
Operating temperature range, controller	5 to 40	°C
Cable length	2	m
Requirements for the photometer used		
Output signal	Analog output, ideally converted from linear to logarithmic	
Output voltage range, max.	–5 to 5	V
Bandwidth, min.	1	kHz
Noise level, max.	–60	dBm

Technical data specified at 20±3 °C.

* The travel ranges of the individual coordinates (X, Y, Z, θ_x , θ_y , θ_z) are interdependent. The data for each axis in this table shows its maximum travel range, where all other axes and the pivot point are at the reference position. See the dimensional drawings for the default coordinate system and pivot point coordinates of the hexapod. Changing the pivot point will reduce the travel range in θ_x , θ_y , θ_z . Changing the orientation of the coordinate system (e.g., when the optical axis is to be the Z axis), will change the travel range in X, Y, and Z.

** Without polynomial linearization

*** Reaching the global maximum after first light has been found

Ask about custom designs!

Fast Multi-Channel Photonics Alignment System

System with 6 Degrees of Freedom for Aligning Fibers and Optical Components

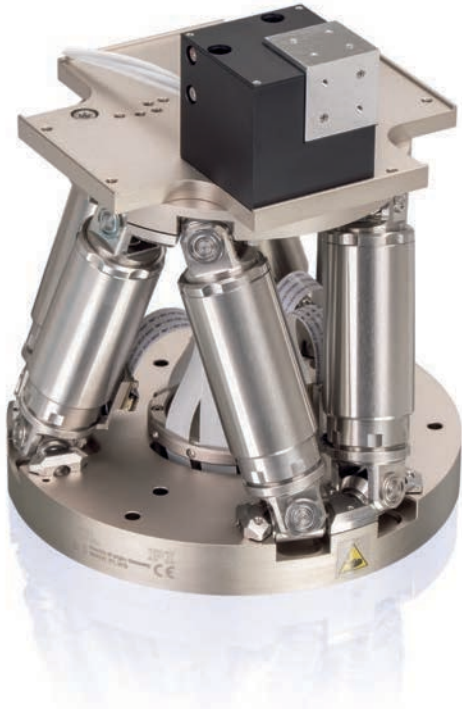

F-712.HU1

- Integrated scan routines for fiber optic alignment
- Ideal for applications in silicon photonics
- Extensive software package
- Direct detection of the optical signal
- Position sensors for high accuracy and operational reliability
- Automatic alignment of several fibers in <1 s

Fast and high-precision drives

The basis of the fiber alignment system is a very stiff set-up with an H-811 hexapod and a P-616 NanoCube® nanopositioner. The parallel-kinematic design for motion in six degrees of freedom ensures high system stiffness. The motorized drives make long travel ranges possible and at the same time, the NanoCube® nanopositioner allows fast scanning motion and dynamic compensation of drift effects. Flexure guides and all-ceramic PICMA® actuators guarantee a long lifetime. Because all drives are equipped with position sensors, the system works precisely and reliably with high repeatability.

High-performance scan routines

The sophisticated scan routines are integrated directly into the controller, which considerably improves the performance and simplifies integration. The system can manage all tasks in the field of fiber alignment. The integrated rotational scans enable fiber arrays to be optimized on all channels very easily.

Extensive software package

The software package supplied in the scope of delivery allows integration of the system into virtually any environment. All common operating systems such as Windows, Linux, and OS X as well as a large number of common programming languages including MATLAB and LabVIEW are supported. Thanks to sophisticated program examples and the use of software tools such as PIMikroMove, the time between starting integrating and productive operation is shortened considerably.

High-resolution analog input

The controller receives the optical intensity signal directly via a high-resolution analog input. Complex set-ups with cameras are not necessary. Various distribution functions are available for determining the maximum intensity.

Application fields

Alignment of optical components and parts, assembling technology in silicon photonics, packaging.



- Hexapod controller using vector algorithms, virtual pivot point
- Commanding in Cartesian coordinates
- Changes of the reference system with a simple command
- TCP/IP and optional analog interfaces, motion stop

Preliminary data	F-712.HU1	Unit
Motion and positioning		
Rough positioning		
Active axes	X, Y, Z, θ_x , θ_y , θ_z	
Travel range in X, Y, Z	$\pm 17, \pm 16, \pm 6.5^*$	mm
Travel range in $\theta_x, \theta_y, \theta_z$	$\pm 10, \pm 10, \pm 21^*$	°
Minimum incremental motion in X, Y	0.1	μm
Minimum incremental motion in Z	0.05	μm
Max. velocity	10	mm/s
Sensor type	Incremental rotary encoder	
Drive type	Brushless DC motor	
Fine positioning		
Active axes	X, Y, Z	
Closed-loop travel in X, Y, Z	100	μm
Min. incremental motion, open-loop	0.3	nm
Min. incremental motion, closed-loop	2.5	nm
Linearity error, for the entire travel range**	2	%
Repeatability (bidirectional) 10 % travel range	2	nm
Sensor type	Incremental linear encoder	
Drive type	PICMA®	
Alignment		
Alignment time area scan 100 μm x 100 μm (max. deviation of peak intensity 0.02 dB)***	<0.5	s
Alignment time gradient search, randomized with $\pm 5 \mu\text{m}$ (repeatability <0.01 dB)***	<0.5	s
Miscellaneous		
Operating temperature range, mechanics	0 to 50	°C
Operating temperature range, controller	5 to 40	°C
Cable length	2	m
Requirements for the photometer used		
Output signal	Analog output, ideally converted from linear to logarithmic	
Output voltage range, max.	-5 to 5	V
Bandwidth, min.	1	kHz
Noise level, max.	-60	dBm

Technical data specified at 20±3 °C.

* The travel ranges of the individual coordinates (X, Y, Z, θ_x , θ_y , θ_z) are interdependent. The data for each axis in this table shows its maximum travel range, where all other axes and the pivot point are at the reference position. See the dimensional drawings for the default coordinate system and pivot point coordinates of the hexapod. Changing the pivot point will reduce the travel range in θ_x , θ_y , θ_z . Changing the orientation of the coordinate system (e.g., when the optical axis is to be the Z axis), will change the travel range in X, Y, and Z.

** Without polynomial linearization

*** Reaching the global maximum after first light has been found

Photometer

Ideal for applications in silicon photonics



F-712.PM1

- Large signal bandwidth of 20 kHz
- High dynamic range
- Wavelength range 400 to 1550 nm
- Current input range 1 pA to 1 mA
- Logarithmic output

Product Overview

This photometer can convert an optical signal into a voltage signal in high resolution and with an extremely high bandwidth. The design of the optical input enables measuring of the optical signal independent of the position of the optical fiber in the connector. The device also has a current input. For example, a photodiode can be connected to this input and the diode current converted into a logarithmic voltage signal. Switching between the inputs is done via a pushbutton; an LED indicates the state.

The large wavelength range of the photometer enables working without switching in the visible and infrared range. The precise, logarithmic output signal is ideal for optical alignment systems. The photometer is therefore suitable for the fastest fully automatic alignment systems available on the market.

Preliminary data	F-712.PM1	Unit
Optical input		
Wavelength range	400 to 1550*	nm
Connectors	FC/PC, FC/APC	
Polarization dependence	None	
Minimum input power at 1550 nm	85	nW
Maximum input power at 1550 nm	85	mW
Average noise at 1550 nm	<10	nW
Current input		
Connectors	BNC	
Minimum input current	1	pA
Maximum input current	1	mA
Average noise	<120	pA
Output		
Connectors	BNC	
Output signal	Analog, logarithmic	
Voltage range	-5 to 5	V
Bandwidth (3dB)	20	kHz
Logarithmic increase	1	V/10 dB
Output voltage at 85 mW, 1550 nm	~+5**	V
Output voltage at 85 nW, 1550 nm	~-1.2**	V
Output voltage at 1 mA input current	+5	V
Miscellaneous		
Operating voltage	12	V
Power consumption	2.4	W
Overall mass	0.6	kg

* Sensitivity distribution device specific. Individual measurement report in scope of delivery.

** Measurement report in scope of delivery.

Compact Positioning and Scanning Stages

PI offers a broad portfolio of drive technologies, stages, and multi-axis assemblies suitable for photonics packaging applications. PI motion controllers are capable of executing alignment algorithms independently of the stage and its drive technology.



P-915

Parallel-kinematic piezo hexapod for fast scanning in 6 degrees of freedom.

- Six DoF nanopositioning system with parallel-kinematic design for best motion performance
- Load capacity 50 g
- Strain gauge sensors
- Smallest 6 DoF system available with 200 μm travel
- Perfectly adapted for beamline experiments, complex optical positioning or alignment tasks

XY, XYZ assemblies, and XYZ assemblies with rotary axis, compact positioning stages with DC motors and gearbox or stepper motors. Compact stages for precision alignment tasks.

- Travel range 13 to 25 mm
- Unidirectional repeatability to 0.1 μm
- Velocity to 2 mm/s (20 mm/s with direct drive)
- Load capacity to 3 kg
- Integrated reference point and limit switch

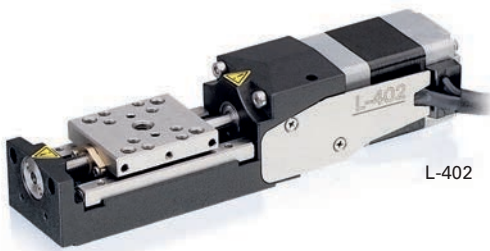

L-402

Linear stage with small width and stepper motor: Classical technology at an affordable price.

- Travel range 13 mm
- Unidirectional repeatability to 0.5 μm
- Velocity to 5 mm/s
- Load capacity to 1 kg
- Integrated reference point and limit switch

- Parallel-kinematic design for the highest stiffness in all spatial directions
- Highly dynamic motion due to high resonant frequencies even with loads up to 30 g
- Innovative product design for flexible use due to single mounting platform

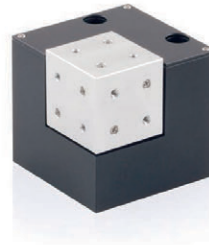

P-616



M-122

- Travel range 25 mm
- Integrated optical encoder for reliable and safe operation
- Recirculating ballscrew drives provide high speeds and long lifetimes
- Max. velocity 20 mm/s



Q-545

- Only 45 mm wide
- Push force 8 N
- Incremental sensors with position resolution 1 nm (optional)
- XY combinations without adapter plate possible
- Velocity 10 mm/s

- Easy configuration and start-up
- Modular design for versatile expansion
- Efficient communication with the controller modules
- Greatly reduced wiring effort
- Saves space and costs



Product Overview

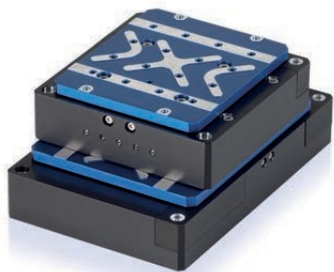

High-dynamic scanners with magnetic direct drives can be easily assembled to fast XY and XYZ combinations.

- Voice coil technology enables fast scanning with travel ranges to 25 mm with a small size
- Long-range travel for loading/unloading can be achieved with magnetic linear or torque motors
- Magnetic direct-drive motors provide a frictionless drive principle for 24/7 operation at high duty cycles

PILine® Piezo motor technology: High velocity and fast start/stop behavior for fast scanning linear and rotary stages.

- Drive torque 5 to 25 mNm
- Self locking when switched off: Saves energy and reduces generation of heat
- Unlimited rotation range >360°
- Positions small loads quickly and with precision: Velocity to 720 °/s
- Minimum incremental motion from 51 to 525 µrad



5-axis set-up with piezo motor technology: Proprietary technology portfolio for space-saving alignment tasks:

- PILINE® XY scanner for fast scanning and point-to-point motion
- Q-Motion goniometers for angular adjustment with a size of 45 x 45 mm²
- High-stability PiezoWalk® drives for vertical motion with nanometer precision and load capacity to 2.5 kg



The smallest possible piezo motors are used in Q-Motion® piezo-electric inertia drives that feature nanometer precision with direct measuring encoders and sizes down to 20 x 20 mm². Q-Motion® stages are available as linear stages, rotary stages, goniometers, and parallel-kinematic SpaceFABs.

- Linear travel range to 32 mm,
- Unidirectional repeatability to 40 nm
- Velocity to 10 mm/s
- Load capacity to 1 kg
- Integrated incremental direct-measuring encoders



Q-821

Product Overview



H-811

- Fast and highly precise Hexapod for six degrees of freedom
- Parallel-kinematic design for compactness and stiffness
- Removable magnetic mount
- Actuator resolution 10 nm
- Integrated automated scan routines
- Ideal for optical alignment applications

- Hexapod with flexure joints
- Includes integrated scan algorithms for fiber optic alignment
- Actuator resolution 33 nm
- Repeatability 0.3 μm / 6 μrad
- Min. incremental motion 0.1 μm / 2 μrad
- Velocity from 10 $\mu\text{m/s}$ to 10 mm/s



H-206

- SpaceFAB offering six degrees of freedom
- ± 7 mm travel range in X and Y, and ± 5 mm in Z
- $\pm 7^\circ$ rotation range in θ_x , θ_y , and $\pm 8^\circ$ in θ_z
- 10 N load capacity, center mounted
- Self-locking, no heat generation at rest



Q-845

Stage Assemblies and Engineered Systems

- A-322: Ideal for scanning applications or high-precision positioning
- Clean room compatible
- Travel ranges to 500 mm x 1000 mm
- Load capacity to 245 N
- Resolution to 1 nm
- Velocity up to 2 m/s

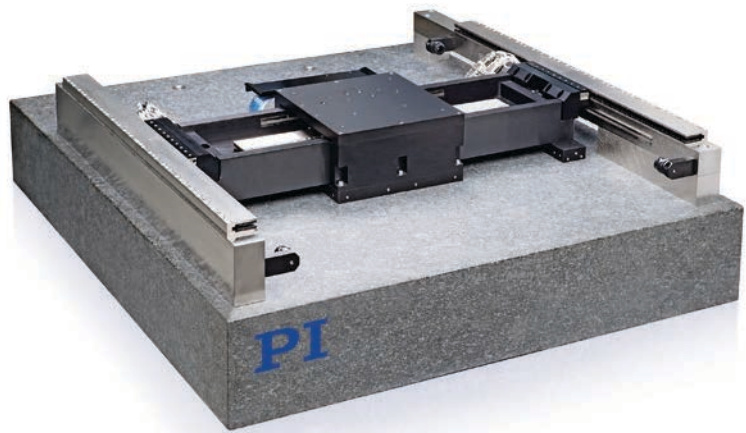

Synchrotron application: Customized parallel-kinematic design for six motion axes (SpaceFAB)

- High load capacity up to 250 kg
- Asymmetrical with long travel ranges so that a sample can be moved into an X-ray
- Designed for use in ion radiation

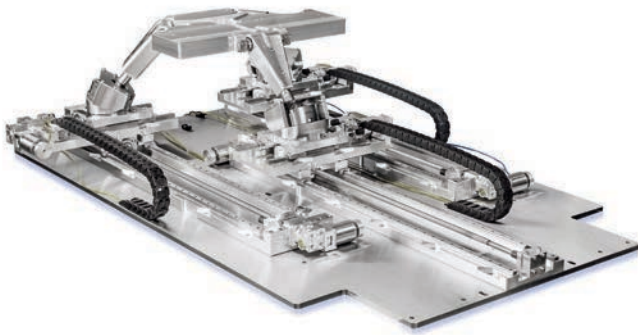

Special design for theta:

- 2-theta scanner that carries detectors for the incident and reflected beam
- The module can be integrated into and is fully functional in a vacuum chamber
- Specialty: Use of radiation-resistant, magnetic encoders because the experiment is sensitive to light

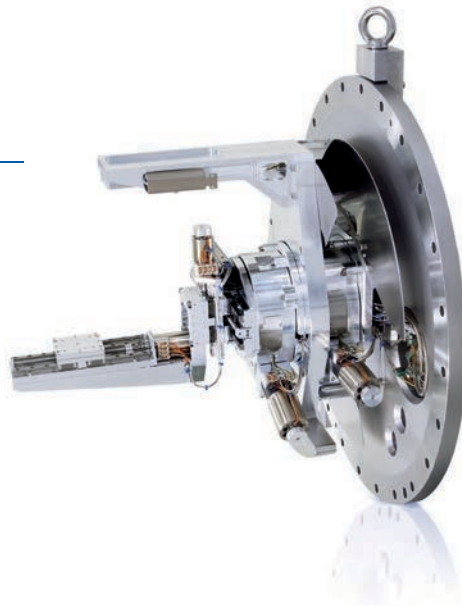



- Very stiff and low vibration construction
- Integrated camera holder for optical inspection of lenses

Gantries are normally equipped with linear motors. Travel ranges of up to 2 meters in XY are possible. If preferred, DC or stepper motors can be used for the Z axis. If nanometer precision is required, piezo actuators take care of dynamic fine adjustment.

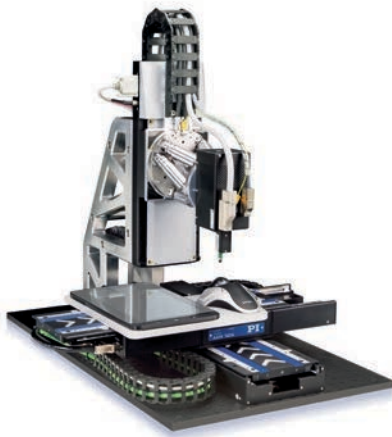
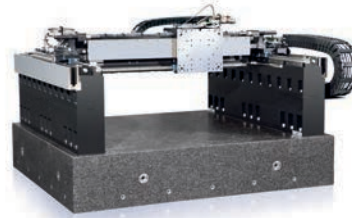

- Single-source supplier
- Industrial interfaces
- Integrated solutions
- Assembly and inspection systems
- Parallel kinematics
- Ethercat

This system for the automated assembly and alignment of the optical fibers on a silicon photonic chip integrates several hardware components and software, such as pick-and-place robot technology, image processing, or devices for precision positioning.

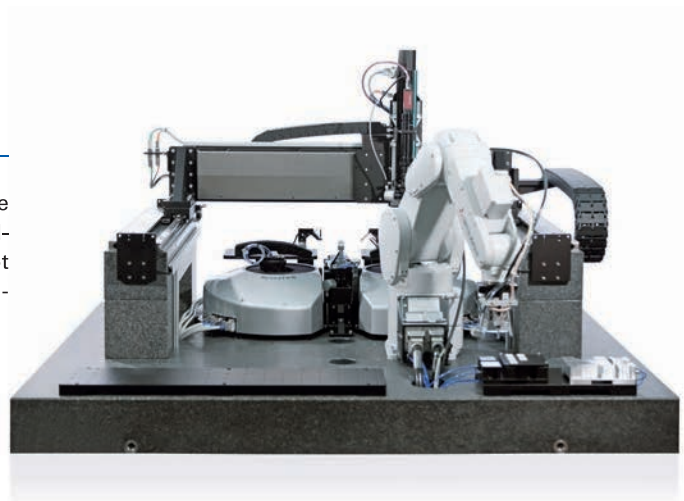

The PI Group Milestones

A Success Story

Well known for the high quality of its products, PI (Physik Instrumente) has been one of the leading players in the global market for precision positioning technology for many years. PI has been developing and manufacturing standard

and OEM products with piezo or motor drives for more than 40 years. In addition to four locations in Germany, the PI Group is represented internationally by fifteen sales and service subsidiaries. All of our customers worldwide can rely on this.

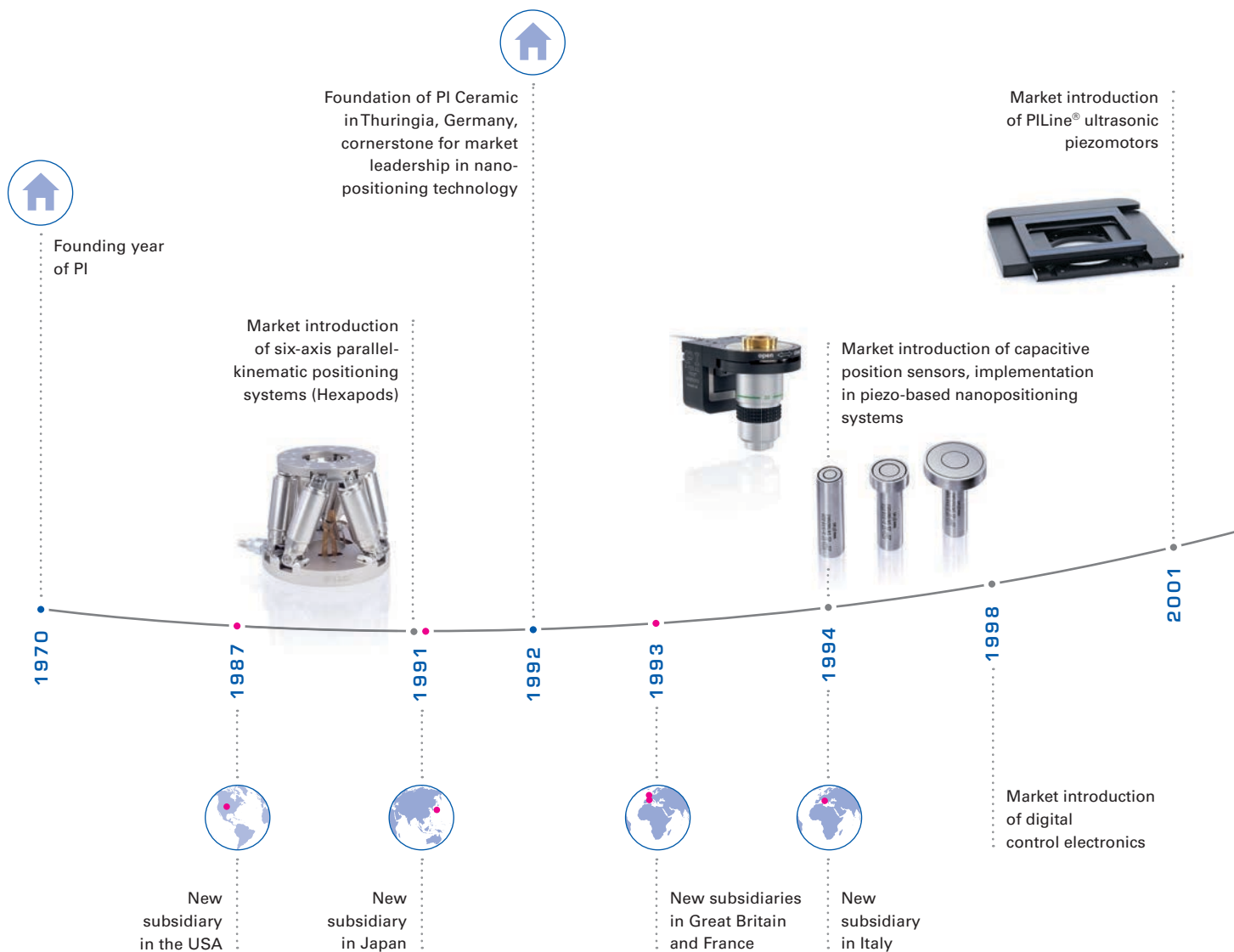

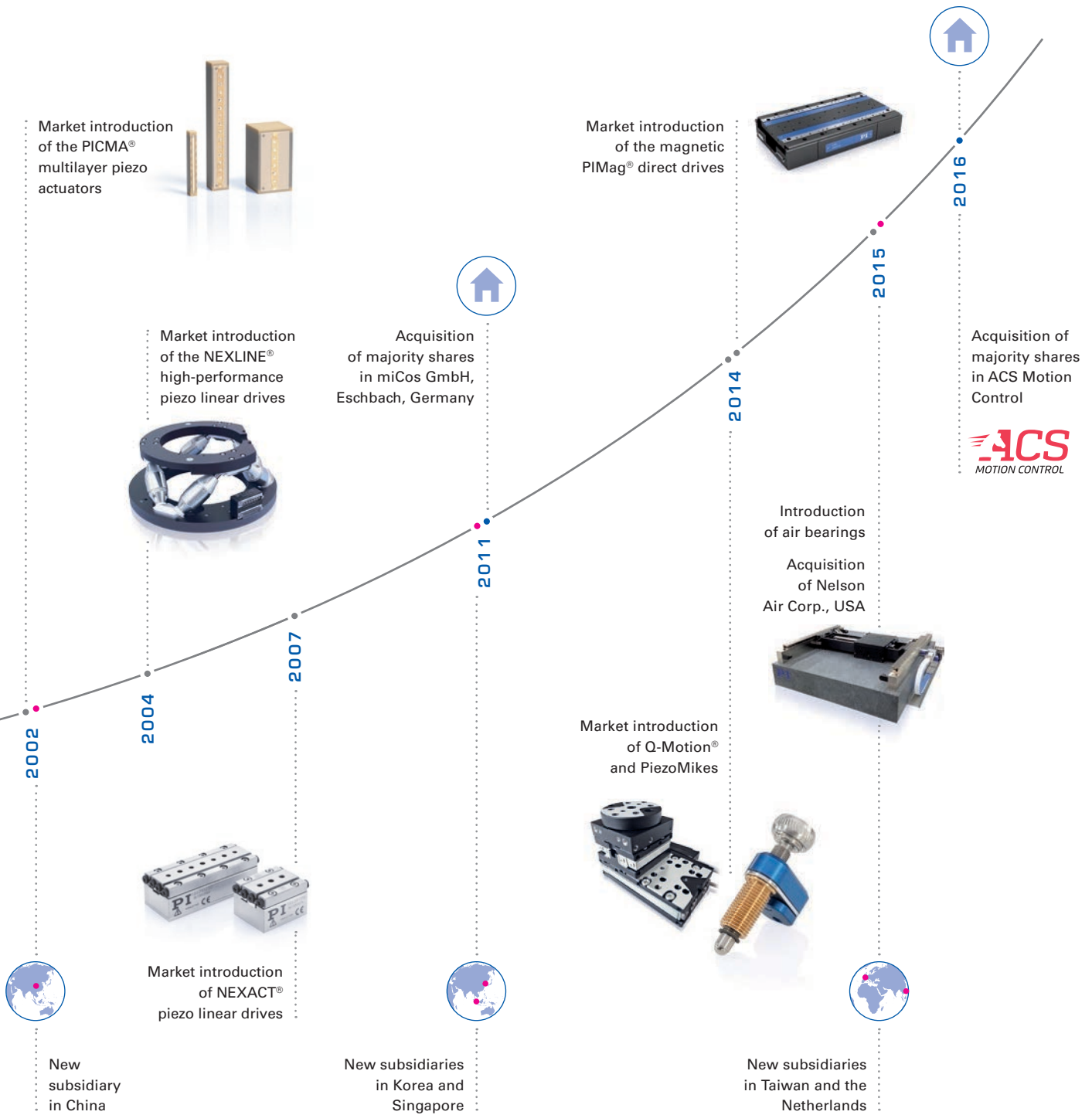



PI HQ, Karlsruhe, Germany

Headquarters

GERMANY

**Physik Instrumente (PI)
GmbH & Co. KG**
Auf der Roemerstrasse 1
76228 Karlsruhe
Phone +49 721 4846-0
Fax +49 721 4846-1019
info@pi.ws
www.pi.ws

PI miCos GmbH
Freiburger Strasse 30
79427 Eschbach
Phone +49 7634 5057-0
Fax +49 7634 5057-99
info@pimicos.com
www.pi.ws

PI Ceramic GmbH
Lindenstrasse
07589 Lederhose
Phone +49 36604 882-0
Fax +49 36604 882-4109
info@piceramic.com
www.piceramic.com



© Physik Instrumente (PI) GmbH & Co. KG

All contents, including texts, graphics, data etc., as well as their layout, are subject to copyright and other protective laws. Any copying, modification or redistribution in whole or in parts is subject to a written permission of PI.

Although the information in this document has been compiled with the greatest care, errors cannot be ruled out completely. Therefore, we cannot guarantee for the information being complete, correct and up to date. Illustrations may differ from the original and are not binding. PI reserves the right to supplement or change the information provided without prior notice.

Subsidiaries

USA (East) & CANADA

PI (Physik Instrumente) L.P.
Auburn, MA 01501
www.pi-usa.us

USA (San Francisco Bay Area)

PI (Physik Instrumente) L.P.
Sausalito, CA 94965
www.pi-usa.us

ITALY

Physik Instrumente (PI) S. r. l.
Bresso
www.pionline.it

FRANCE

PI France SAS
Aix-en-Provence
www.pi.ws

JAPAN

PI Japan Co., Ltd.
Tokyo
www.pi-japan.jp

CHINA

**Physik Instrumente
(PI Shanghai) Co., Ltd.**
Shanghai
www.pi-china.cn

SOUTHEAST ASIA

**PI (Physik Instrumente)
Singapore LLP**
Singapore
www.pi-singapore.sg
For ID / MY / PH / SG / TH / VNM

KOREA

PI Korea Ltd.
Seoul
www.pikorea.co.kr

USA (West) & MEXICO

PI (Physik Instrumente) L.P.
Irvine, CA 92620
www.pi-usa.us

UK & IRELAND

PI (Physik Instrumente) Ltd.
Cranfield, Bedford
www.physikinstrumente.co.uk

NETHERLANDS

PI Benelux B.V.
Sint-Oedenrode
www.pi.ws/benelux

SPAIN

Micos Iberia S.L.
Vilanova i la Geltrú
www.pimicos.es

PI Japan Co., Ltd.
Osaka
www.pi-japan.jp

**Physik Instrumente
(PI Shanghai) Co., Ltd.**
Beijing
www.pi-china.cn

TAIWAN

**Physik Instrumente (PI)
Taiwan Ltd.**
Taipei
www.pi-taiwan.com.tw