



# Piezo Nano Positioning

---

2013/2014

# Contents

---

About PI starting from page 4

---

Piezo Positioning Systems starting from page 17



Piezo Scanners for Nano-Precision Positioning in 1 to 6 Axes Page 18

Z Piezo Scanners for Microscopy Page 44

Precision Motion Control: Piezo Amplifiers and Controllers for Nanopositioning Page 56

Nanometrology Page 72

Nanopositioning Technology Page 76

---

Piezo Drives starting from page 99



Piezomotors Page 100

Piezomotor Technologies Page 104

Piezo Actuators with Guiding and Preload Page 110

Technology: Guiding and Preload Page 116

Piezo Actuators and Piezo Components Page 118

Fundamentals of Piezo Technology Page 126

---

---

## Hexapod and SpaceFAB: Parallel Kinematics with 6 Motion Axes

starting from page 159



Hexapod and SpaceFAB

Page 160

Controller for Hexapod Positioning Systems

Page 176

Accessories

Page 178



Technology of Parallel-Kinematic Precision Positioning Systems

Page 180

---

## Motorized Positioning Systems

starting from page 191



Precision Linear Stages

Page 192



Precision XY Stages

Page 216



Precision Rotary Stages

Page 222

Motorized Precision Linear Actuators

Page 234

Motion Controllers

Page 244



Basics of Motorized Positioning Systems

Page 252

---

Patents

Page 268

---

Imprint

Page 269

---

# PI Group



**No other company in the world offers a broader and deeper portfolio of precision motion technologies than the PI Group. Continuous growth through the development of novel products and technologies is one of the main characteristics of the PI Group.**

With more than 700 highly qualified employees all over the world, research and manufacturing centers on three continents and subsidiaries in 13 countries, the PI Group is in a position to fulfill almost any requirement with regard to innovative precision motion technology.



Typical for PI: PIFOC® objective scanner – nanometer resolution for precision focus control in microscopy

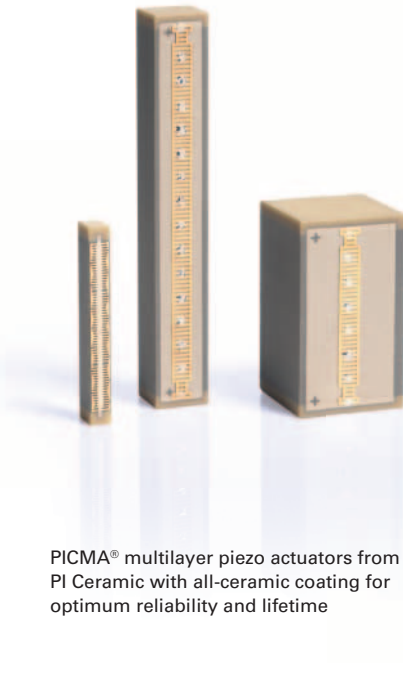

PICMA® multilayer piezo actuators from PI Ceramic with all-ceramic coating for optimum reliability and lifetime



SpaceFAB positioning system from PI miCos. Parallel kinematics for positioning in up to six degrees of freedom

## Unique in Piezo Technology and Precision Positioning

### Physik Instrumente (PI) – Precision Positioning for Industry and Research

PI was founded more than four decades ago and is considered today a global market and technology leader in the field of precision positioning technology with accuracies to the sub-nanometer range. At the development and manufacturing site in Karlsruhe, more than 350 employees work on high-resolution drive systems and positioning solutions.

### PI Ceramic – Piezo Technology Specialist

PI Ceramic currently employs 200 people. It was founded in Lederhose (Thuringia, Germany) in 1992 as development and manufacturing site for piezoelectric transducers. Today, it is one of the world leaders in the field of piezo actuators and sensors used for wealth of applications, reaching from precision positioning to metrology, and from ultrasound generation to energy recovery.

### PI miCos – Motion Control and Systems Integration

PI miCos, founded in 1990 in Eschbach, Germany, joined the PI Group in 2011. With currently more than 60 employees, the company develops, produces and markets unique systems and components for high-precision positioning applications throughout the world. It mainly focuses on positioning technology under vacuum conditions, air-bearing solutions, linear motors and integration of complex systems such as used in beamline instrumentation.

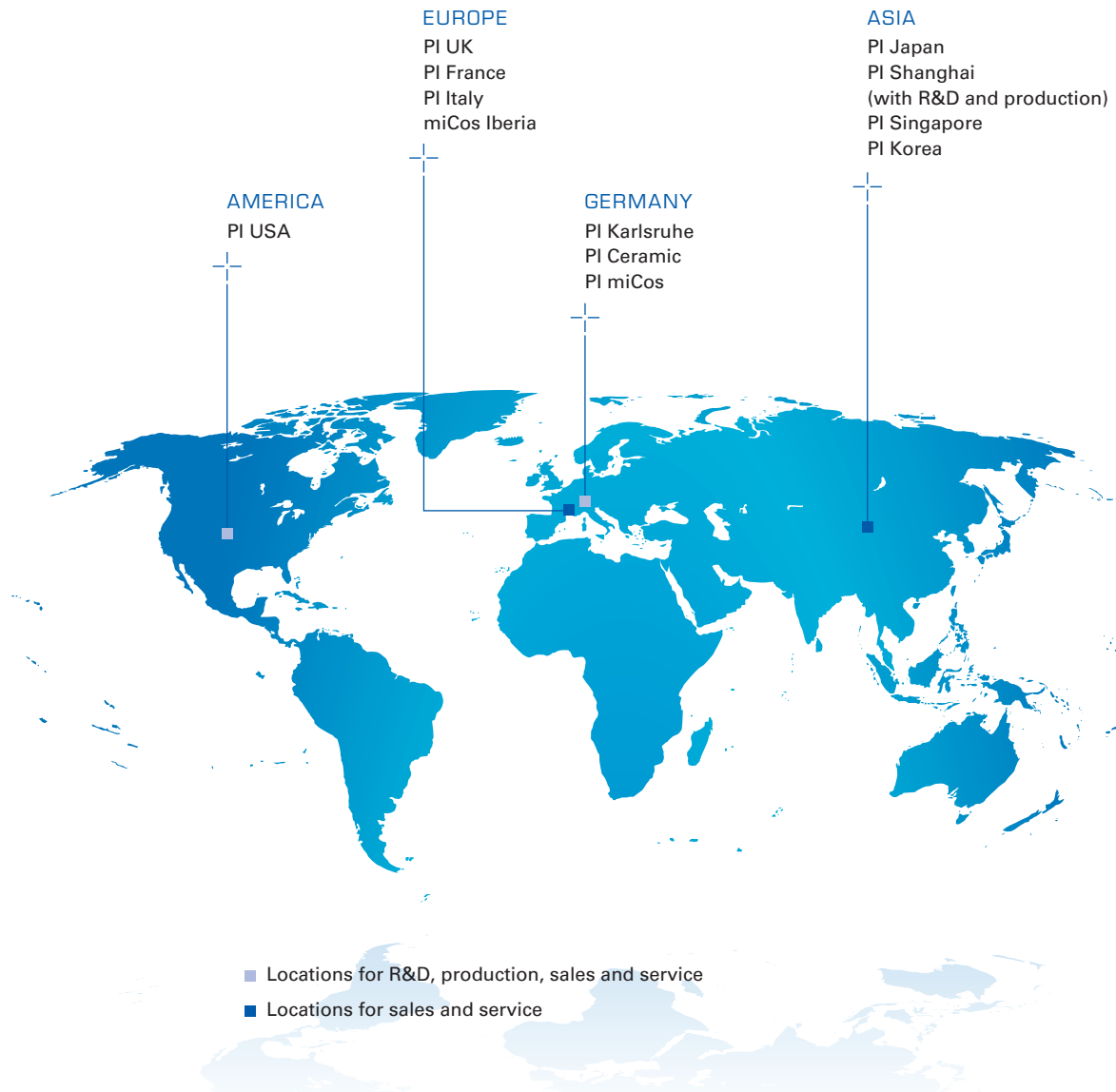

**The PI Group is present in all key technology regions worldwide. Customers benefit from its local representations around the globe in many ways:**

- Service facilities for diagnosis and repair as well as metrology equipment for tests, system calibration and quality assurance
- R&D departments, which are able to react promptly to the demands of the local markets and ensure a direct dialog with the customers
- Sample and prototype construction – in close contact with development departments and customers
- Sales and application engineers – experts for the entire product portfolio of the PI Group and your contact for customized developments – from the initial consultation to the delivery
- Market and business development experts who listen to what customers in specific market segments want and enable the PI Group to develop products that fulfill these requirements

## Well-Positioned All Over the World



- 1970** PI founding year
- 1977** PI moved its headquarters to Waldbronn, Germany
- 1991** Market launch of 6-axis parallel-kinematics positioning systems (Hexapods)
- 1992** Foundation of PI Ceramic, Thuringia, Germany; crucial step towards market leadership in nanopositioning
- 1994** Market launch of capacitive position sensors
- 1998** Market launch of digital control electronics
- 2001** Market launch of PIShift® ultrasonic piezomotors
- 2001** New company building in Karlsruhe, Germany
- 2002** PI Ceramic company building extended
- 2004** Market launch of PICMA® multilayer piezo stack actuators
- 2004** Market launch of NEXLINE® high-performance piezo linear drives
- 2007** Market launch of NEXACT® piezo linear drives
- 2010** More space for growth: Acquisition of the expansion site next to the PI headquarters
- 2011** Acquisition of the majority shares of miCos GmbH
- 2012** Extension of the PI headquarters and PI Ceramic company buildings
- 2012** Introduction of PIMag 6D magnetic levitation positioning system
- 2013** Market launch of PiezoMike linear actuators based on PIShift inertia drives

# Dear customers,



PI is a synonym for top performance in precision motion technologies. We wish to in-spire you with our products and we believe that we have exactly what it takes. PI offers a technological spectrum that is beyond competition worldwide. Piezo actuator technology, voice-coil drives, magnetic levitation technology, nanometrology sensors and digital controllers – we can implement all of these technologies for any high-precision motion task. Piezo ceramics are such an elementary part of our portfolio that we founded an entire company to produce the highest quality piezo materials in the world: PI Ceramic. This way, we are independent from general purpose components available on the market and can offer all key technologies from one source. This is what makes PI different and unique. And we need to be unique to satisfy your specific requirements in drive and positioning technology.

However, technology is not our only strength. Even more important are all the people working for and with PI. Permanent improvement of the workflow, flat hierarchies, direct communication, both internally and with our customers, are a very good basis. Our employees are looking forward to working for you. We wish to delight you with our solutions.

Yours sincerely,

Dr. Karl Spanner, President of PI

## From the Mission Statement of Physik Instrumente (PI) GmbH



The "Wall of Fame": Far more than 100 patents and patent pending technologies in the fields of nanopositioning, positioning controllers and piezoelectric drive systems

Integrated management system: Quality control, environmental protection and protection of health and safety at work, certified to ISO 9001, ISO 14001, OHSAS 18001



"PI is a strongly expanding, privately owned company. PI stands for quality in products, processes and service. The development and manufacture is completely under the control and responsibility of PI. Profitability is required for financial independence and a prerequisite for reinvestments in new technologies. It guarantees stability and a reliable partnership with our customers.

We, at PI, want to be our customers' partners and look for long-term customer relationships. Conditions to achieve this goal are fair prices and a mutual support when it comes to solving problems."



# Unconventional Ways

**The PI Group can respond precisely to the customers' needs: Specific requirements can often only be fulfilled by customized solutions – solutions that can only be found by means of unconventional and creative thinking.**

## Unique Solutions, Broadest and Deepest Portfolio in Precision Motion Technologies

PI feels at home where unconventional solutions are of the essence in both industry and research. Today nanotechnology is also present in standardized industrial processes. With unconventional thinking and the broadest and deepest portfolio of precision motion technologies at hand, PI is in a position to offer solutions that far exceed the performance of general purpose systems. Understanding the customers' requirements is essential in finding a creative, sometimes surprisingly unconventional solution. The technological range available to PI always permits different approaches not limited to one single technology right from the start, an advantage that turns into a considerable competitive edge for the customer.

## Why Scientists Rely on PI: Creativity for Research and Development

Thousands of scientific publications cite PI products because our systems help researchers achieve outstanding results faster. Custom developments for research customers are a daily business for PI. The spectrum reaches from modifications of standard products to special designs for extreme ambient conditions. Important fields of research are, for example, beamline instrumentation, micro systems and nanotechnology.

## OEM Customers Benefit from Our Integrated Management System

Optimized processes allow PI to provide customized products in quantities up to several 100 000 units cost-efficiently with exact adherence to supply deadlines. The range of OEM products offered by the PI Group varies, from "compact actuators" and sensors to highly integrated parallel-kinematic positioning systems with custom digital controllers and software. Evaluation of pre-production run samples, test procedures, production processes and quality management are all included in the development process.

The complete control over the design and manufacturing process provides the customer with significant advantages, because PI can modify and customize its products in all areas: Mechanics, electronics, metrology systems and software. Such solutions often go beyond the state-of-the-art, providing customers the competitive edge that is necessary to be successful in the market.

## Control of All System-Critical Processes and Design Steps

The PI Group controls the design and manufacturing steps of all critical components from the piezo material to the mechanical construction, from the nanometrology sensors to the digital control circuits and software. This approach not only yields superior system performance but also allows us to support our systems for many years in the future, a fact that is appreciated by customers in research and industry alike.



Precision steering mirror for an astronomical project requiring ultra-high stability and resolution. For this project, long-travel PI NEXLINE® linear drives were combined with absolute-measuring sensors

Small, smaller, smallest: Customer-specific drive solutions manufactured by the PI Group include a 30 mm wide positioner with electro-magnetic gear motor, a piezomotor-driven camera focus unit for mobile devices and piezo chip actuators manufactured in large quantities at low cost

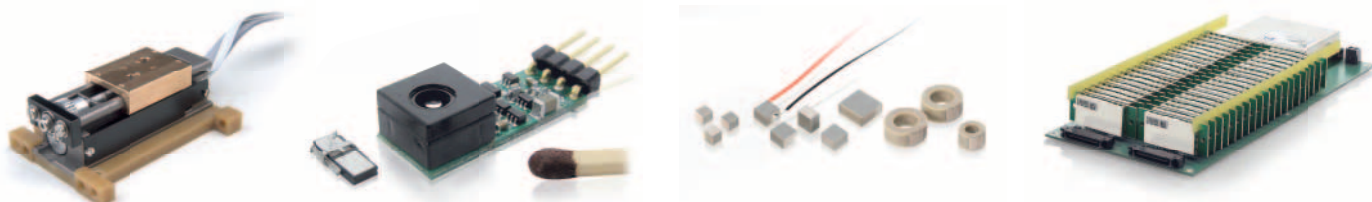

# PI Group and Its Markets



Complex three-dimensional structure: A 300 µm Statue of Liberty was manufactured with 3D laser lithography by Nanoscribe (Photo: Nanoscribe GmbH)

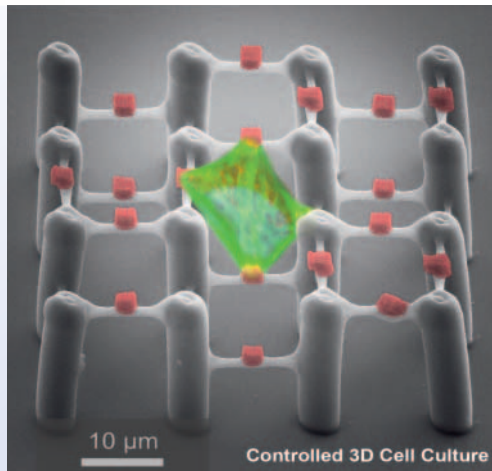

Three-dimensional structure: Cells settle on "handles" (Photo: B. Richter and M. Bastmeyer, Zoological Institute, Karlsruhe Institute of Technology (KIT))



Drives that are both small and accurate improve imaging processes e.g. in medical technology. (Photo: SCHÖLLY FIBEROPTIC GmbH)



Hexapods in automation. In addition to PLC connection, control over standardized G-Code commands is possible to allow for even higher flexibility



Curiosity investigates the geology on Mars supported by PI drive motion systems (Photo: NASA/JPL)

## Small and Large-Scale Precision

What does nanolithography have in common with astronomy? As different as they seem to be, both require precision motion with accuracy down to nanometers. With its decades of engineering and manufacturing experience in nanopositioning and drive systems, PI has been working with world-class leaders in industry and research in these particular fields and many others.

## Semiconductor Technology

The semiconductor industry is a pioneer when it comes to commercializing nanotechnology. Modern computer chips already require structures which are only a few nanometers wide. PI's piezomotor and actuator systems help to precisely align wafers, imaging optics and mask. Semiconductor test and inspection systems equally rely on the performance characteristics of PI positioning systems.

## Vacuum-Compatible, Non-Magnetic and Suitable for Low Temperatures

PI's piezoelectric drive systems can be modified to cope with extreme ambient conditions, such as ultrahigh vacuum, strong magnetic fields or extremely low temperatures. Piezoceramics are intrinsically compatible with these extreme conditions, but the selection of the right system components and the assembly process requires a lot of experience. PI miCos is an expert in classical drive technologies for UHV, in particular when it comes to designing complex multi-axis systems for high loads and long travel ranges.

## Medical Technology

Piezo ceramics to generate ultrasonic waves, actuators for microdosing and the production of nanoliter drops as well as miniature piezomotors for mobile medication devices – all these are tasks for which the PI Group has been offering solutions for many years. For imaging processes, such as OCT, focusing or miniature zoom lenses, small and reliable drive systems are increasingly required. PI can offer products for all of these applications.

## Biotechnology

Biotechnological applications using precise positioning system from PI are not only limited to typical optical procedures, such as focusing, or to moving and manipulation of samples in microscopy or in genome sequencers. Also for nano dosing and microfluidics, PI drive systems are unbeatable. For example, they allow the dosing of smallest volumes, with both high speed and high precision, in procedures such as PipeJet, or the design of the finest structures by means of nanoimprint or 3D lithography.

## Microscopy

Optical methods have been relying on PI positioning systems for years, e.g. for aligning optical systems or samples. Piezo actuators and motors are increasingly replacing conventional drive systems because they are more compact, more precise and faster. Other non-optical microscopic processes, such as SEM (scanning electron microscope) and AFM (atomic force microscope), use PI systems due to their high accuracy and dynamics.

## Imaging Methods

Nowadays, numerous industries depend on faster and more precise imaging methods. In all markets, the required tasks are focusing, zoom, object alignment and higher resolution. This ranges from the inspection of surface structures on semiconductors or flat screens with white-light interferometry to optical microscopy, and from the digitalization of documents to image stabilization for aerial photography and astronomy. In all of these fields, the PI Group is present with its precise, highly stable and dynamic positioning systems.

## Industrial Automation

PI positioning systems can communicate directly with a PLC through fieldbus interfaces. They can be integrated in virtually every automated production line. A synchronized clock with other automated components can easily be achieved. Hexapod parallel-kinematic positioners can also be used in automated manufacturing processes and for precision alignment.

## Astronomy and Aerospace Research

Highest precision and dynamics are required in astronomy to follow the motion of stars or to compensate atmospheric interferences. Hexapods from PI align secondary mirrors of telescopes with a precision of 1  $\mu\text{m}$  or better; piezo-driven active mirrors increase the optical resolution and align the elements of large segmented mirrors. Today the PI Group is even present on Mars with two of its systems: Piezo actuators separate rock samples, motorized drives focus a camera and laser spectrometer on the Mars rover Curiosity science lab.

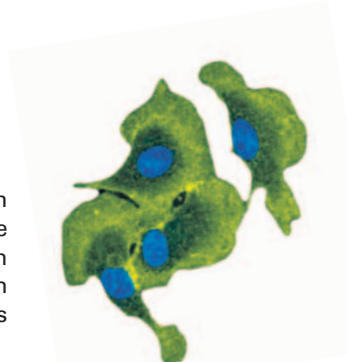

Endothelial cells as seen under the microscope (Photo: Lemke Group, EMBL Heidelberg)

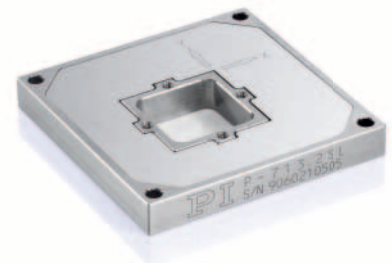

Low-profile, cost-efficient piezo scanner for biometrics: The CCD chip is moved dynamically in two axes to increase the pixel resolution



SpaceFAB: 6-axis positioning system for  $10^{-6}$  hPa



## PI Ceramic Piezo Technology

PI Ceramic is considered a global leading player in the field of piezo actuators and sensors. The product range includes various piezo ceramic elements manufactured in both multilayer and pressing technology. Piezo ceramic components are manufactured in a large number of forms and sizes and with different motion characteristics.

The broad range of expertise in the complex development and manufacturing process of functional ceramic components combined with state-of-the-art production equipment ensure high quality, flexibility and adherence to supply deadlines. Prototypes and small production runs of custom-engineered piezo components are available after very short processing times. PI Ceramic also has the capacity to manufacture medium-sized to large series in automated lines.



Instruments for the removal of tartar with ultrasound, OEM product. The individual piezo disks can be clearly seen

### PI Ceramic provides

- Piezo ceramic materials
- Lead-free piezoelectric materials
- Piezo ceramic components
- Customized and application-specific transducers / ultrasonic transducers
- PICMA® monolithic multilayer piezo actuators
- Miniature piezo actuators
- PICMA® multilayer bending actuators
- PICA high-load piezo actuators
- PT piezo tube actuators
- Preloaded actuators with case
- Piezocomposites – DuraAct patch transducers

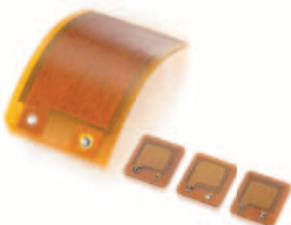

DuraAct transducers can be used as sensors, actuators and for energy harvesting





## PI miCos Motion Control

Frequently, the complete integration of multiple axes of high-precision positioning systems is required. Some examples are the preparation of experiments in large research facilities, optical measurement technology, photonics automation as well as test and calibration facilities in industrial applications. PI miCos delivers turn-key solutions from one source. All critical mechanical components are manufactured in-house at PI miCos achieving the highest performance characteristics.

The product range includes linear and rotation stages, multi-axis SpaceFAB robot systems and matching motion controllers with corresponding software. Furthermore, PI miCos offers special product lines for use in vacuum up to  $10^{-10}$  hPa or under cryogenic conditions.

Typical examples for successfully integrated system solutions are found in flexible positioning systems with linear motors and air-bearing technology as well as in robotics systems that allow motions with six degrees of freedom and have been specially developed for optical measurement technology and photonics automation.

Positioning in vacuum in up to six axes is one of the fields of expertise of PI miCos

Top performance for excellent results: Research institutions rely on the unique combination of technical know-how and perfect implementation, which guarantees, for example, a high resolution rotary stage motion without wobble and backlash

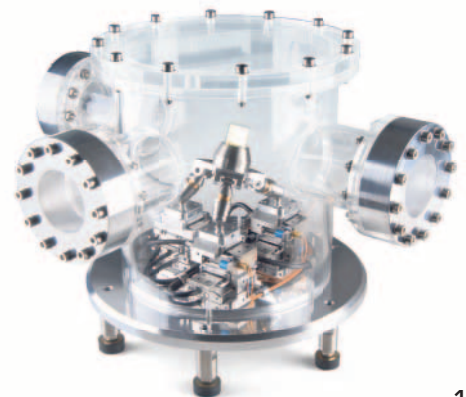

# Everything Under One Roof



## Technology Under Control

Customer and application-specific product developments are the basis for the success of the PI Group. Requirements have to be understood and a technological solution has to be found. Since the PI Group manufactures all key technologies in-house, technology and production can be adapted perfectly to fulfill the requirements. Evidence is provided by our products.

## The Good Feeling When Your Expectations Are Met

Customers should know the performance of the system they use. Therefore, an informative measurement log is part of every supplied closed-loop nanopositioning system. All measurements are made with external, traceable measurement devices, such as high-resolution interferometers.

The combined lift and swivel unit carries up to seven tons and permits 360° rotations. This allows us to qualify, for example, high-load Hexapods with load in the exact same orientation as in the customer's application





A seismic, electromagnetic and thermal isolation of the test laboratories guarantees a stable temperature with a variation of less than 0.25°C in 24 hours. Measuring accuracies down to picometers set standards in the measurement of nanopositioning equipment

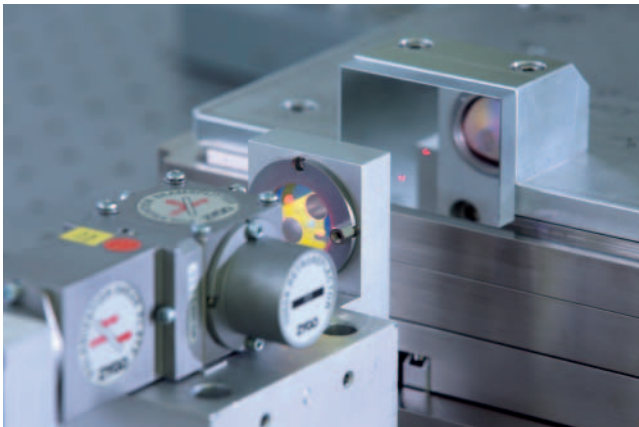

High-precision piezo positioning systems are measured using high-quality calibrated interferometers

### Qualification in a Wide Range

The product range from a two-ton Hexapod to a 10-gram nanopositioner requires that PI can both manufacture and qualify these systems. At our Karlsruhe headquarters, a heavy-load shop floor was recently added, in which masses up to five tons can be handled. Special measurement devices, such as high-resolution 6D laser trackers, qualify the heavy-load precision positioning systems in every orientation.

Nanopositioning systems require stable measurement conditions for qualification. Measuring rooms with stable climatic conditions, isolated from the building foundation and thus from external vibrations, provide ideal ambient conditions for the high-resolution measurement devices, such as interferometers and capacitive sensors.

### Complete Systems

PI positioning systems are complete solutions, i.e. they are delivered with everything required for operation. This includes, unless otherwise specified, power supplies, cables, mains and network cables, and, of course, the software. A plethora of program libraries, examples and drivers facilitate integration and programming of the systems e.g. under Linux, Windows, MATLAB or LabVIEW. In addition, every controller comes with the PIMikroMove graphical user interface program for easy start-up and system optimization.



### Visit Us on the Web at [www.pi.ws](http://www.pi.ws)

For detailed technical specifications, drawings, CAD files and additional products not shown here, visit our website at [www.pi.ws](http://www.pi.ws). There you will also find our newsletters and updates on the latest developments and applications as well as general information on the PI Group.

### Downloading Software and User Manuals

PI provides a wealth of software tools along with rich documentation and detailed user manuals. Visit our website frequently to stay up to date. Actually, our PI Update Finder will help you identify the PI software on your computer automatically, compare it to the versions available on the PI server and direct you to the latest release.







# Piezo Precision Positioning Stages

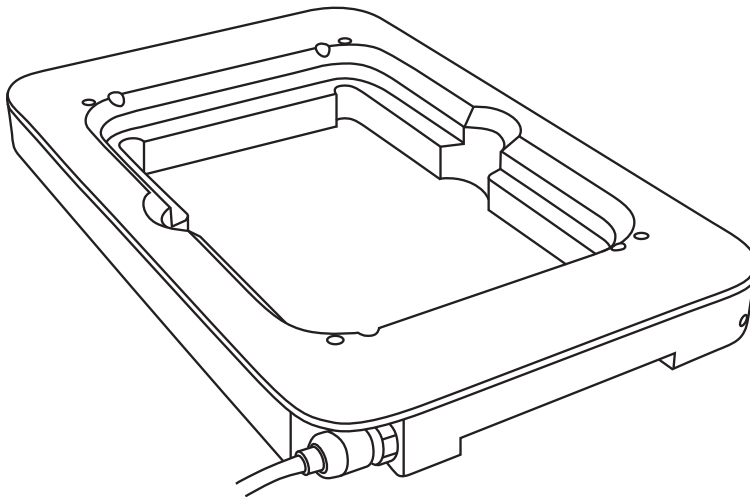

---

**Products**

**Page 18–75**

---

**Technology**

**Page 76–95**

---

# Piezo Scanners for Nano-Precision Positioning

In 1 to 6 Axes

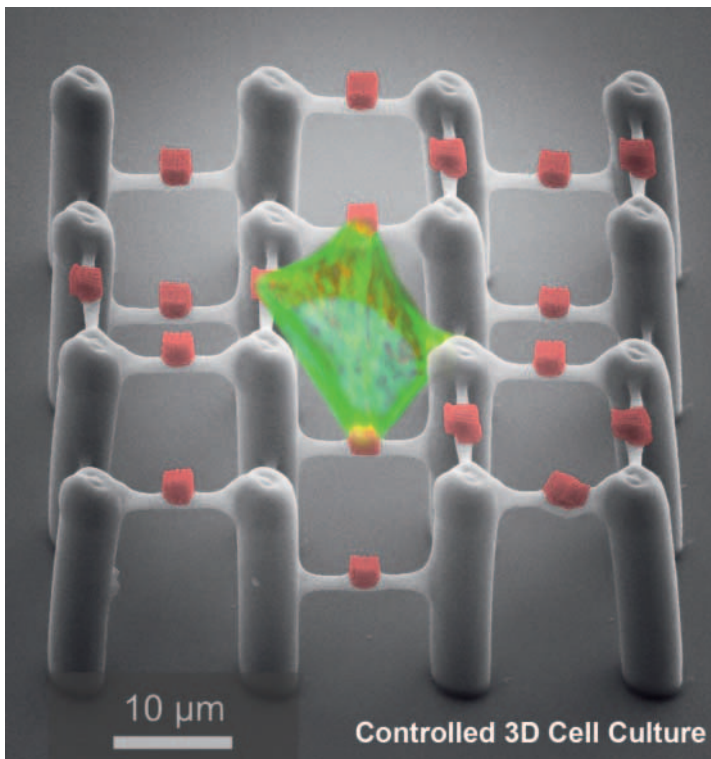

Three-dimensional structure: Cells settle on "handles".  
(Photo: B. Richter and M. Bastmeyer, Zoological Institute, Karlsruhe Institute of Technology (KIT))

Nanotechnology is already part of everyday life. The use of high-precision positioning systems in biotechnology, microscopy or semiconductor technology allows resolution of very fine structures in production and inspection. This allows production of more and more powerful integrated electronic components and investigation of new diagnostic and therapeutic methods in life sciences.



**Single-Axis Piezo Scanning Stages**  
Reference-Class Nanopositioning Systems

**Page 20**



**Piezo Z Scanners**  
Compact Positioning Stage for the Vertical Axis

**Page 22**

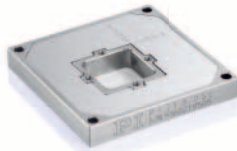

**Piezo Scanning Stages for 1 to 3 Axes**

**Page 26**

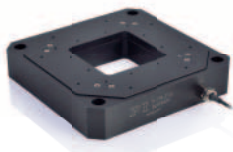

**Precision Positioning Stage for up to 6 Axes**  
Reference-Class Piezo Systems

**Page 38**



**PicoCube® XYZ Piezo Scanners for AFM**

**Page 40**



**Fast Tip/Tilt Mirrors**  
Active Optics

**Page 42**

# Single-Axis Piezo Scanning Stages

Reference-Class Nanopositioning Systems



P-753

## Highlights

- Excellent precision
- For dynamic applications
- PICMA® piezo actuators for maximum reliability
- Capacitive position sensors for positioning accuracy and stability in the nanometer range
- Frictionless and zero-backlash flexure guides

## Applications

PI's piezo-actuator linear stages combine nanometer-precision resolution and guiding precision with minimum crosstalk. This makes them particularly suitable for reference applications in metrology, for microscopic processes, for interferometry or in inspection systems for semiconductor chip production.

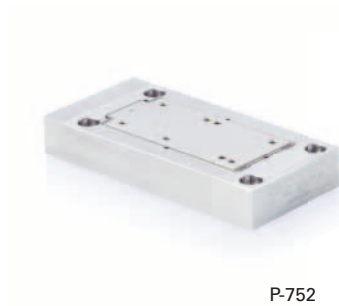

P-752



P-753

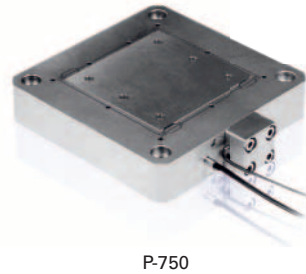

P-750

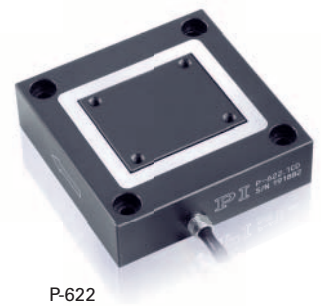

P-622

## P-752

## P-753

## P-750

## P-620 to P-629

	P-752	P-753	P-750	P-620 to P-629
	Excellent guiding accuracy	LISA actuator and nanoscanning stage: for vertical and horizontal use	For high loads	PIHera: XY and Z versions available
Dimensions in mm	66 to 84 × 40 × 13.5	44 to 80 × 30 × 15	115 × 115 × 25	30 × 30 × 12 to 100 × 100 × 22.5
Closed-loop travel range in $\mu\text{m}$	15 to 30	12 to 38	75	50 to 1500
Load capacity in N	30	100 vertical, 20 horizontal	100	10
Closed-loop resolution in nm	up to 0.1	0.05 to 0.2	1	up to 0.2
Linearity error in %	0.03	0.03	0.03	up to 0.02
Repeatability in nm	$\pm 1$ to $\pm 2$	$\pm 1$ to $\pm 3$	$\pm 3$	up to $\pm 1$
Crosstalk $\theta_x/\theta_z$ in $\mu\text{rad}$	$\pm 1$	$\pm 5$ to $\pm 10$	$\pm 10$	$\pm 3$ to $\pm 10$
Stiffness in N/ $\mu\text{m}$	up to 30	up to 45	12.5	up to 0.4
Unloaded resonant frequency in Hz	up to 3 200	up to 5 600	600	up to 1 100

# Piezo Z Scanners

## Compact Positioning Stages for the Vertical Axis



P-622

## Highlights

- Frictionless and zero-backlash flexure guides
- PICMA® piezo actuators for maximum reliability
- Open-loop designs available

## Applications

Vertical piezo positioning stages are used for the alignment of optics in laser metrology and also for focusing samples in microscopy or in test systems. PI offers vertical positioning stages in different designs for a wide range of applications.



P-611.Z

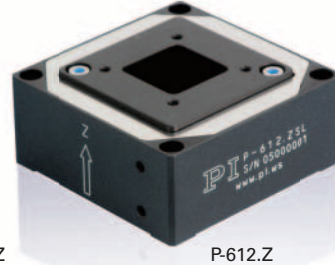

P-612.Z



S-303.BL

P-620.Z  
P-621.Z  
P-622.Z

P-611.Z

P-612.Z

S-303

	High precision in combination with long travel ranges	Cost-efficient	Compact with clear aperture	Highly dynamic piezo phase shift stage
Options	PIHera: XY und Z versions available	X, XY or XZ versions available	XY versions available	version with Picoactuator® drive for high linearity in open-loop operation
Dimensions in mm	30 × 30 × 15 to 50 × 50 × 17.5	44 × 44 × 27	60 × 60 × 27	Ø 30 × 10, open-loop with Ø 8 mm of clear aperture
Closed-loop travel range in µm	up to 250	100	100	2
Load capacity in N	10	15	15	0.5
Sensor	capacitive	SGS	SGS	capacitive
Closed-loop resolution in nm	up to 0.1	2	1.5	0.03
Linearity error in %	0.02	0.1	0.2	1
Repeatability in nm	±1	<10	±4	0.7
Crosstalk $\theta_x/\theta_z$ in µrad	<80	±20	–	–
Stiffness in N/µm	up to 0.6	0.45	0.63	–
Unloaded resonant frequency in Hz	up to 1000	460	490	25 000

# Z and Tip/Tilt Piezo Scanning Stages

With Large Clear Aperture

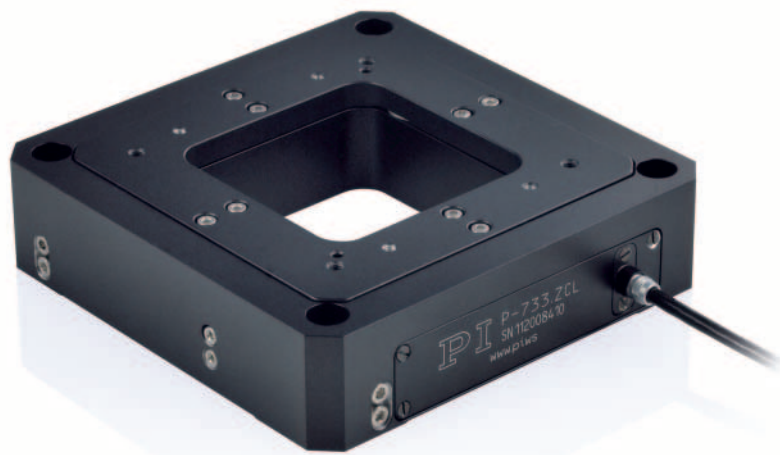

P-733

## Highlights

- Fast step-and-settle in the ms range
- Parallel kinematics for best possible precision with multi-axis motion
- Frictionless and zero-backlash flexure guides
- PICMA® piezo actuators for maximum reliability

## Applications

PI's vertical positioning stages with large clear aperture are available with different features to fit each individual application. The main areas of application include various microscopic processes for alignment and Z-stacking of samples. In addition, PI offers special scanning stages for commercially available microscopes.





P-541

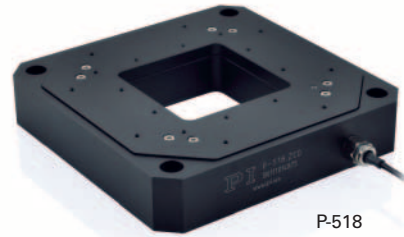

P-518

P-541.ZC  
P-541.TC

P-541.ZS  
P-541.TS

P-733.Z

P-518  
P-528  
P-558

	Reference class	Precision class	Reference class: High guiding accuracy	Reference class: High dynamics in Z and tip/tilt axes
Options	XY versions available	XY versions available	XY and XYZ versions, vacuum versions available	XY and XYZ versions, vacuum versions available
Dimensions in mm	150 × 150 × 16.5	150 × 150 × 16.5	100 × 100 × 25	150 × 150 × 30
Active axes	Z, $\theta_x$ , $\theta_y$	Z, $\theta_x$ , $\theta_y$	Z	Z and Z, $\theta_x$ , $\theta_y$
Clear aperture in mm	66 × 66	66 × 66	50 × 50	66 × 66
Closed-loop travel range in $\mu\text{m}$	100	100	100	up to 200
Closed-loop tip/tilt range $\theta_x$ , $\theta_y$ in mrad	$\pm 0.6$	$\pm 0.6$	–	up to $\pm 1$
Load capacity in N	50	50	50	100
Sensor	capacitive	SGS	capacitive	capacitive
Closed-loop resolution in nm	0.5	2.5	0.3	1
Resolution in the tip/tilt range in $\mu\text{rad}$	0.08	0.25	–	up to 0.05
Linearity error in %	0.03	0.2	0.03	0.03
Repeatability in nm	$\pm 2$	$\pm 10$	$\pm 2$	up to $\pm 5$
Crosstalk $\theta_x$ / $\theta_z$ in $\mu\text{rad}$	<15	<15	<5	<100
Stiffness in N/ $\mu\text{m}$	0.8	0.8	2.5	up to 4
Unloaded resonant frequency in Hz	410	410	700	up to 570

# Low-Cost 1- and 2-Axis Piezo Scanning Stages

Standard Class of High Dynamics

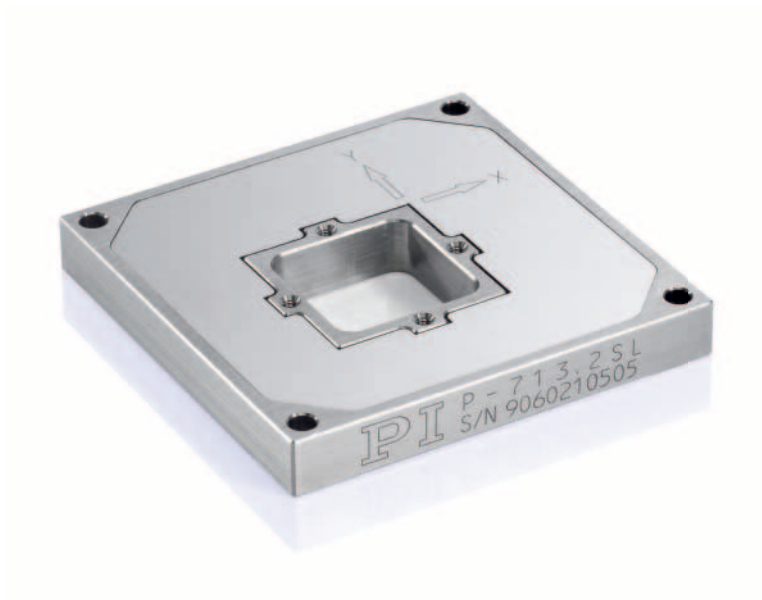

P-713

## Highlights

- Fast piezo stages
- SGS position sensors optimized for high linearity
- Serial and parallel-kinematic designs
- Highly dynamic through direct drive
- Frictionless and zero-backlash flexure guides
- PICMA® piezo actuators for maximum reliability

## Applications

Fast X and XY piezo scanners for small loads are frequently used for microstepping processes. Their rapid step-and-settle improve the resolution of optical systems. These include imaging processes in camera technology and image recognition, for example for biometrics or document archiving.

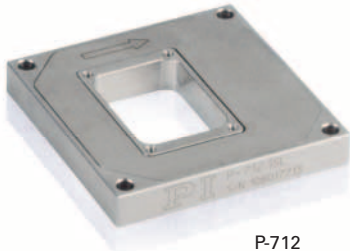

P-712

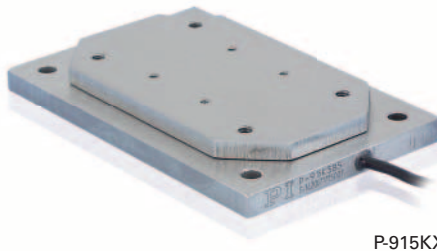

P-915KXYS



P-915KHDS

## P-712

## P-713

## P-915K XYS

## P-915K HDS

	Large clear aperture 12 × 15 mm <sup>2</sup>	Large clear aperture 15 × 15 mm <sup>2</sup>	Customized model	Customized model with large clear aperture 30 × 45 mm <sup>2</sup>
Active axes	X	X,Y	X,Y	X,Y
Dimensions in mm	40 × 40 × 6	45 × 45 × 6	40 × 60 × 7	85 × 54 × 12.5
Clear aperture in mm	20 × 15	15 × 15	–	30 × 45
Sensor	SGS	SGS	–	–
Closed-loop travel range in μm	30	15 × 15	4 × 4 open-loop	15 × 15 open-loop
Closed-loop resolution in nm	2	1	0.4 open-loop	0.1 open-loop
Linearity error in %	0.3	0.3	–	–
Repeatability in nm	±5	±4	–	–
Crosstalk $\theta_x/\theta_z$ in μrad	±5 / ±20	±1 to ±5 / ±40 to ±50	up to ±50	–
Stiffness in N/μm	0.6	0.8	–	10
Unloaded resonant frequency in Hz	1550	2 250	> 2 000	1850
Load capacity in N	5	2	0.5	5

# NanoCube®

Low-Cost Positioning in up to 3 Axes, Precision-Class



P-611

## Highlights

- Cost-efficient
- Modular design of multi-axis systems
- SGS position sensors
- PICMA® piezo actuators for maximum reliability

## Applications

The NanoCube® is an all-rounder in nanopositioning technology, offering the best possible alternative to reference-class systems. Its applications include sample adjustment, handling in microsystem technology, sample handling, fiber positioning and photonics.



P-611.2, P-611.XZ



P-611.3

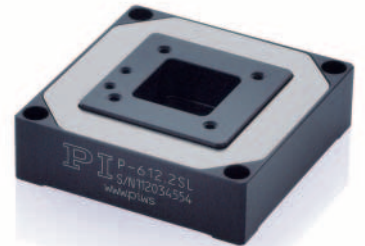

P-612

## P-611.1

## P-611.2 P-611.XZ

## P-611.3

## P-612

	P-611.1	P-611.2 P-611.XZ	P-611.3	P-612
Active axes	X	X, Y or X, Z	X, Y, Z	X, Y
Dimensions in mm	44 × 44 × 17	44 × 44 × 34	44 × 44 × 44.2	60 × 60 × 18
Clear aperture in mm	–	–	–	38 × 38
Sensor	SGS	SGS	SGS	SGS
Closed-loop travel range in $\mu\text{m}$	100	100	100	100
Closed-loop resolution in nm	2	2	2	5
Linearity error in %	0.1	0.1	0.1	0.4
Repeatability in nm	<10	<10	<10	<10
Crosstalk in $\mu\text{rad}$	max. $\pm 20$	max. $\pm 20$	max. $\pm 20$	max. $\pm 50$
Stiffness in $\text{N}/\mu\text{m}$	0.2	0.2 to 0.35	0.3	0.15
Unloaded resonant frequency in Hz	400	up to 340	up to 350	400
Load capacity in N	15	15	15	15

# PIHera Nanopositioning Stage for 1 to 3 Axes

Large Variety of Reference-Class Piezo Scanning Stages

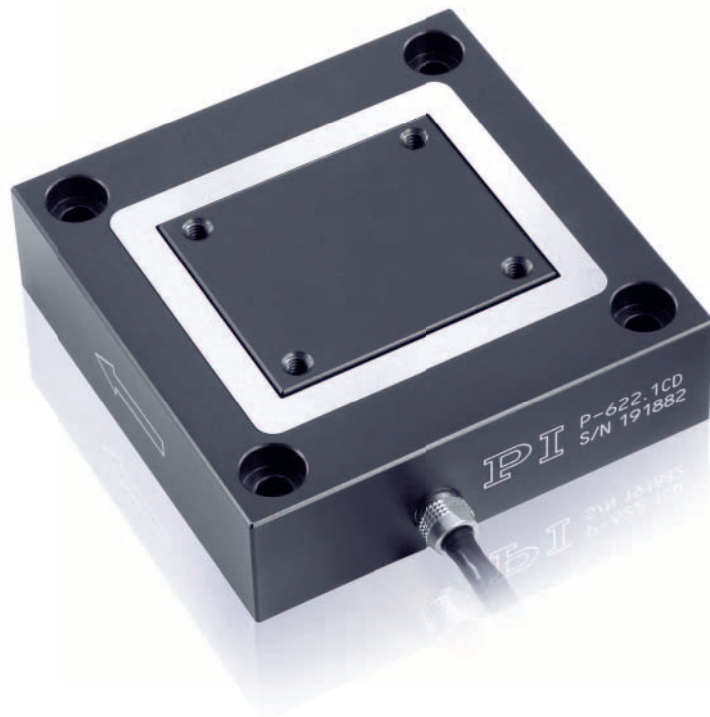

P-622

## Highlights

- High-precision piezo positioning systems with travel ranges of up to 1500  $\mu\text{m}$
- Short response and settling times in the millisecond range
- Capacitive position sensors for maximum positioning accuracy and stability
- PICMA<sup>®</sup> piezo actuators for maximum reliability
- Frictionless and zero-backlash flexure guides

## Applications

The piezo scanners of the PIHera range show in exemplary fashion the history of success of PI's nanopositioning systems. Their compact design makes them suitable for universal use and allows serial assembly of multi-axis systems at low cost. Their applications include, for example, optical metrology, biotechnology and atomic force microscopy.

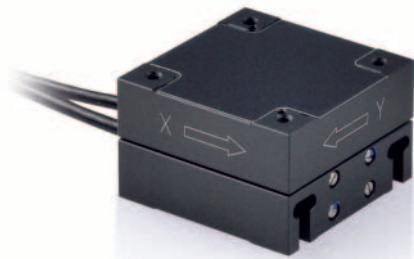

P-621.2CD



P-622.ZCD

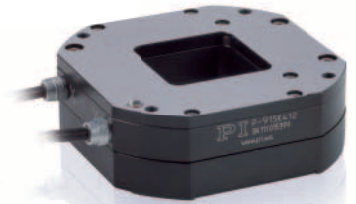

P-763.22C

P-620.1  
to  
P-629.1

P-620.2  
to  
P-629.2

P-620.Z  
P-621.Z  
P-622.Z

P-763

	1 axis	XY axes	Z axis	XY axes with clear aperture, preliminary data
Dimensions in mm	30 × 30 × 12 to 100 × 100 × 22.5	30 × 30 × 21.5 to 100 × 100 × 40	30 × 30 × 15 to 50 × 50 × 17.5	60 × 60 × 22
Clear aperture in mm	–	–	–	30 × 30
Closed-loop travel range in μm	50 to 1500	50 to 1500	50 to 250	200
Closed-loop resolution in nm	0.2 to 3	0.2 to 3.5	0.2 to 1	0.7
Linearity error in %	up to 0.02	up to 0.02	0.02	0.02
Repeatability in nm	±1 to ±14	±2 to ±14	±1	±2
Crosstalk in μrad	±3 to ±10	±3 to ±30	<20 to <80	±50
Unloaded resonant frequency in Hz	up to 1 100	up to 800	up to 1000	up to 200
Load capacity in N	10	10	10	3

# Low-Profile XY Piezo Scanners

With Large Clear Aperture for Microscopy



P-541

## Highlights

- Flexible adjustment possible, e.g. for microscopes
- Particularly low profile
- Large selection of position sensors
- Backlash-free flexure guides
- PICMA® piezo actuators for excellent reliability

## Applications

The nanopositioning stages of the P-540 series are designed for applications in microscopy. Their typical low-profile design allows easy integration into existing structures. Depending on the task at hand, the drive system ranges from particularly dynamic for tracking applications to long travel ranges for superresolution microscopy.





P-545

P-541.C  
P-542.C

P-541.S  
P-542.S

P-541.2  
DD

P-545  
PI nano<sup>®</sup>

	High precision through capacitive sensors Reference-class	Low-cost version with SGS sensors Precision-class	Directly driven and dynamic Reference-class	Low-cost for microscopy, up to 3 axes Precision-class
Active axes	X,Y	X,Y	X,Y	X,Y,( Z)
Dimensions in mm	150 × 150 × 16.5	150 × 150 × 16.5	150 × 150 × 16.5	217 × 150 × 20
Clear aperture in mm	80 × 80	80 × 80	80 × 80	82 × 65
Sensor	capacitive	SGS	capacitive	piezoresistive, capacitive
Closed-loop travel range in $\mu\text{m}$	100 to 200	100 to 200	45	70 to 200
Closed-loop resolution in nm	0.3 to 0.7	2.5 to 4	0.3	<1
Linearity error in %	0.03	0.2	0.03	0.1
Repeatability in nm	< $\pm 5$	< $\pm 10$	< $\pm 5$	–
Crosstalk in $\mu\text{rad}$	< $\pm 5$ to $\pm 10$	< $\pm 5$ to $\pm 10$	< $\pm 3$	–
Kinematic design	parallel	parallel	parallel	serial
Unloaded resonant frequency in Hz	up to 255	up to 255	1 550	1 000 (X,Y), 800 (Z)
Load capacity in N	20	20	20	5

# 2-Axis Flexure Scanner with Excellent Travel Accuracy

Reference-Class Piezo Systems



P-733

## Highlights

- Motion in X and Y
- Optimized travel accuracy
- Parallel kinematics with capacitive sensors
- Backlash-free flexure guides
- PICMA® piezo actuators for excellent reliability
- Large clear aperture

## Applications

Reference-class nanopositioning stages are suitable for sample positioning in high-resolution, non-optical microscopy.

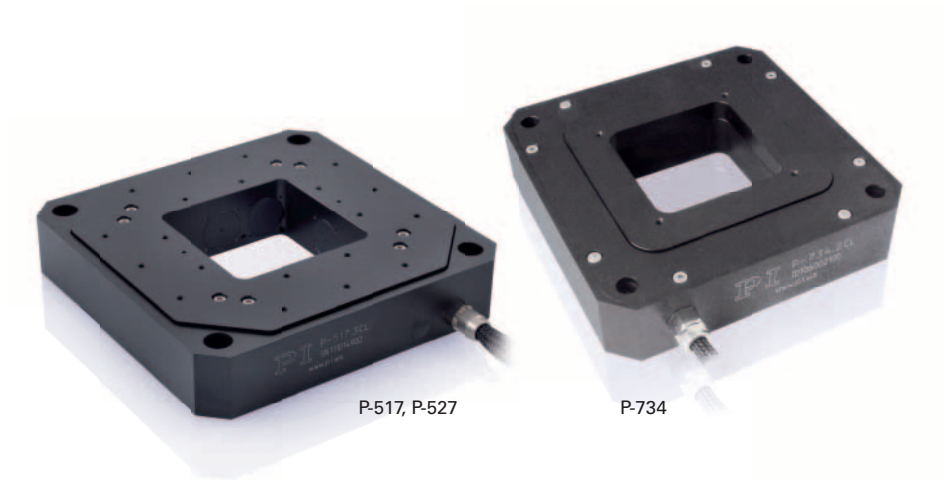

P-733.2

P-733.2  
DD

P-517.2  
P-527.2

P-734

	Compact and precise	Directly driven and dynamic	Travel range of up to 200 $\mu\text{m}$	Travel flatness <5 nm
Dimensions in mm	100 × 100 × 25	100 × 100 × 20	150 × 150 × 30	130 × 130 × 30
Clear aperture in mm	50 × 50	50 × 50	66 × 66	56 × 56
Closed-loop travel range in $\mu\text{m}$	100	30	100 to 200	100
Closed-loop resolution in nm	0.3	0.1	1 to 2	0.3
Linearity error in %	0.03	0.03	0.03	0.03
Repeatability in nm	<±2	<±2	±5 to ±10	<±2.5
Crosstalk in $\mu\text{rad}$	<±3 to ±10	<±5 to ±10	–	<±3 to ±10
Unloaded resonant frequency in Hz	500	2 230	up to 450	500
Load capacity in N	50	50	50	20

# 3-Axis Piezo Scanning Stages

## Reference-Class Piezo Systems

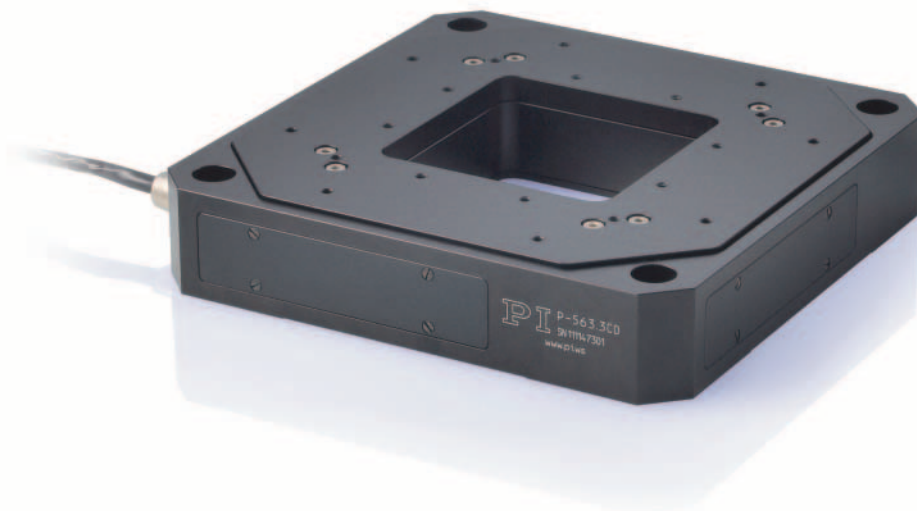

P-563

## Highlights

- Motion in X, Y and Z
- High travel accuracy
- Large clear aperture
- Parallel kinematics with capacitive sensors
- Backlash-free flexure guides
- PICMA® piezo actuators for excellent reliability

## Applications

Three-axis nanopositioning stages scan a sample in-plane both in optical and non-optical microscopy and adjust it along the measuring axis. Further fields of application include interferometry, 3D laser lithography and nano imprint technologies.

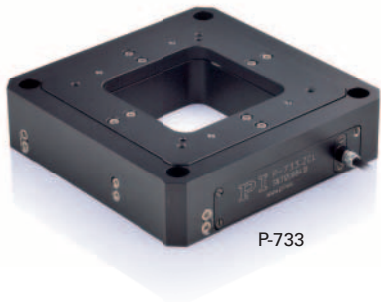

P-733



P-517

## P-733.3

## P-517.3 P-527.3

## P-561 P-562 P-563

## P-561.3 DD

	Compact and precise Highly dynamic Z axis	High dynamics to up to 200 $\mu\text{m}$ Highly dynamic Z axis	PIMars series, also available for 6 axes Long travel range also in Z	Directly driven high- dynamics PIMars
Dimensions in mm	100 × 100 × 25	150 × 150 × 30	150 × 150 × 30	150 × 150 × 30
Clear Aperture	40 × 40	66 × 66	66 × 66	66 × 66
Closed-loop Z travel range in $\mu\text{m}$	10	20	100 to 300	15
Closed-loop X, Y travel range in $\mu\text{m}$	100 × 100	100 × 100 to 200 × 200	100 × 100 to 300 × 300	45 × 45
Closed-loop X, Y resolution in nm	0.3	1 to 2	0.8 to 2	0.2
Closed-loop Z resolution in nm	0.2	0.1	0.8 to 2	0.2
Linearity error in %	0.03	0.03	0.03	0.01
Repeatability in nm	<2	±1 to ±10	2	2
Crosstalk in $\mu\text{rad}$	<±10	–	±6 to ±10	±3
Crosstalk around X, Y with motion in Z in $\mu\text{rad}$	<±5	–	±15 to ±25	±3
Resonant frequency X, Y in Hz	460	up to 450	up to 190	920
Resonant frequency Z in Hz	1 400	1 100	up to 380	1 050
Load capacity in N	50	50	50	50

# Precision Positioning Stage for up to 6 Axes

Reference-Class Piezo Systems

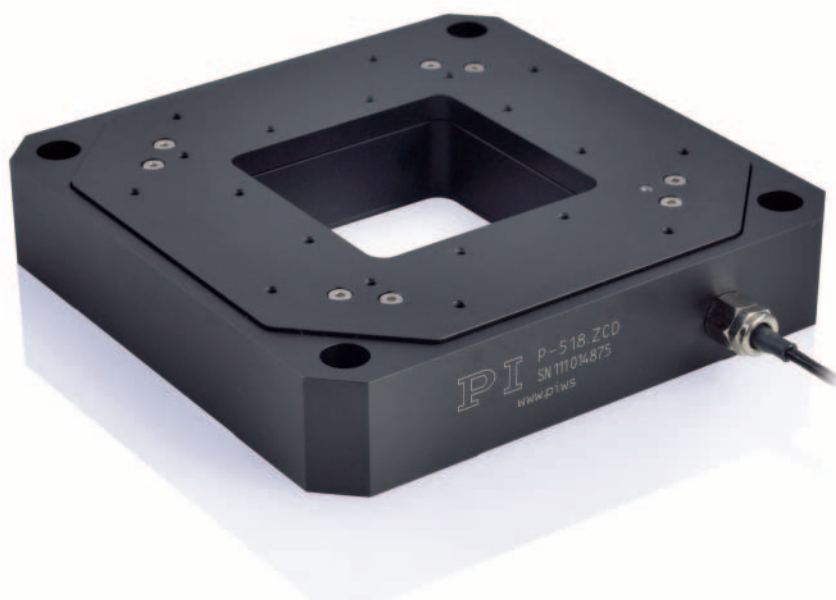

P-518

## Highlights

- Parallel kinematics with capacitive sensors
- Capacitive position sensors of maximum linearity
- PICMA® piezo actuators for maximum reliability

## Applications

Differential operation of the actuators for one direction of motion combined with a digital motion controller allows samples or measuring sensors to be aligned not only in the linear axes but also additionally in tilt and rotary angles.

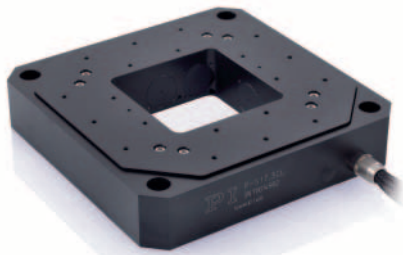

P-517

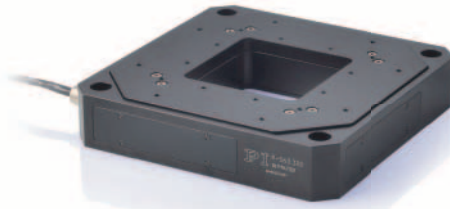

P-563



P-587

P-517.R  
P-527.R

P-518.T

P-562.6

P-587

	Rotational axes with clear aperture	Tip/tilt axes with clear aperture	PIMars, compact design	Large travel ranges
Active axes	X, Y, $\theta_z$	Z, $\theta_x$ , $\theta_y$	X, Y, Z, $\theta_x$ , $\theta_y$ , $\theta_z$	X, Y, Z, $\theta_x$ , $\theta_y$ , $\theta_z$
Dimensions in mm	150 × 150 × 30	150 × 150 × 30	150 × 150 × 30	240 × 240 × 50
Clear aperture in mm	66 × 66	66 × 66	66 × 66	–
Closed-loop travel range in $\mu\text{m}$	100 to 200	50 to 200	200	800, 800, 200
Closed-loop resolution in nm	0.3 to 1	up to 0.5	1	0.7 to 2.2
Closed-loop tilt angle in mrad	$\pm 1$	$\pm 0.25$ to $\pm 1$	$\pm 0.5$	$\pm 0.5$
Closed-loop angle resolution in $\mu\text{rad}$	0.01	0.05	0.1	up to 0.1
Linearity error X, Y, Z / $\theta_x$ , $\theta_y$ , $\theta_z$ in %	0.03	0.03	0.01 / 0.1	0.01 / 0.1
Repeatability X, Y / Z in nm	$\pm 5$	$\pm 5$ to $\pm 10$	$\pm 2$ / $\pm 3$	$\pm 3$ / $\pm 2$
Repeatability $\theta_x$ , $\theta_y$ / $\theta_z$ in $\mu\text{rad}$	$\pm 0.5$	up to $\pm 0.03$	$\pm 0.1$ / $\pm 0.15$	$\pm 0.1$ / $\pm 0.15$
Unloaded resonant frequency X / Y / Z in Hz	450	up to 570	110 / 110 / 190	103 / 130 / 235
Load capacity in N	50	100	50	50

# PicoCube<sup>®</sup> XYZ Piezo Scanners for AFM

---

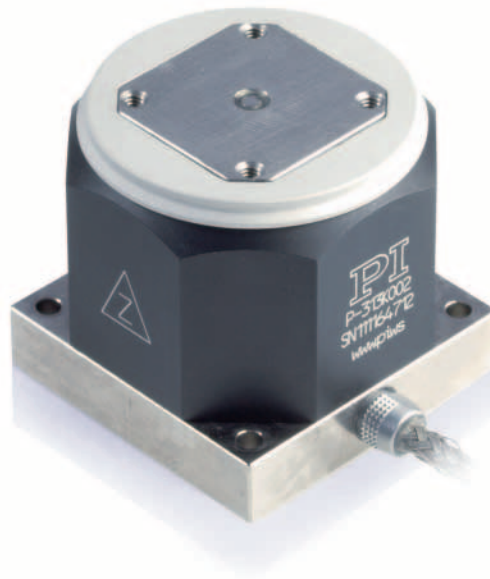

P-313

## Highlights

- Picometer resolution
- Parallel-kinematic design
- High dynamics through direct drive
- Nonmagnetic and UHV versions available

## Applications

Atomic force microscopy (AFM) permits surface inspection with highest resolution, even down to atomic levels. It enters dimensions that light microscopes can no longer resolve. This method can provide information on the topography, chemical surface condition, defects, etc. Typical areas of application include life science technologies, materials research and semiconductor inspection. Piezo-based scanning systems provide the required precision in the positioning of measuring tip and sample, thus ensuring the desired high spatial resolution and high dynamics.





P-363



E-536

## P-313

## P-363

## E-536 PicoCube® Piezo Controller

	Picoactuator® technology for highly linear displacement without position sensor		
Active axes	X, Y, Z	X, Y, Z	
Dimensions in mm	30 × 30 × 29.4	30 × 30 × 29.4	
Sensor	–	capacitive	
Closed-loop travel range in μm	up to 1	5	
Closed-loop resolution in nm	–	0.1	
Linearity error in %	0.2	0.05	
Crosstalk in μrad	–	0.5	
Crosstalk with motion in Z in μrad	–	0.2	
Unloaded resonant frequency X, Y / Z in Hz	4000 / 11000	3100 / 9800	
Load capacity in N	10	10	
Operating voltage in V	±250	±250	
			<ul style="list-style-type: none"> <li>■ With or without servo control</li> <li>■ With or without digital interfaces</li> <li>■ Output voltage -250 to +250 V</li> <li>■ Peak current per channel up to 200 mA, &lt;3 ms</li> <li>■ Bandwidth, small signal 10 kHz</li> <li>■ Ripple, noise, 0 to 100 kHz &lt;0.8 mV<sub>rms</sub></li> </ul>

# Fast Tip/Tilt Mirrors

## Active Optics



S-334

## Highlights

- Two orthogonal, parallel-kinematic tip/tilt axes with common pivot point
- Optional linear axis for adjustment of the optical path length
- Compact design
- Operating frequencies from 100 Hz to >1 kHz
- PICMA® piezo actuators for maximum reliability
- Optional strain gauge sensors for high accuracy
- Frictionless and zero-backlash flexure guides

## Applications

Due to their high dynamics and the two tilt axes featuring a common pivot point, tip/tilt mirrors are used for laser beam steering and control. Applications include industrial materials processing and medical technology, for example in ophthalmology or dermatology. Image stabilization is a further field of application, which benefits from the high dynamics of the system.



S-330



S-325



S-340

## S-330

## S-334

## S-325

## S-340

	Fast and flexible tilt angles	Large tilt angles with premounted mirror	High speed due to additional closed-loop Z axis	Wide range of different materials such as invar, aluminum, titanium
Dimensions in mm	Ø 25 x 37 to 91	25 x 33 x 38	Ø 25 x 50	60 x 60 x 56
Active axes	$\theta_x, \theta_y$	$\theta_x, \theta_y$	$\theta_x, \theta_y, Z$	$\theta_x, \theta_y$
Integrated sensor	SGS	SGS	SGS	SGS
Closed-loop tilt angle* in mrad	up to 10	25 and 50	5	2
Closed-loop resolution in $\mu$ rad	0.05 to 0.5	1 and 5	0.05	0.2
Linearity error in %	0.25	0.05	0.05	0.1
Unloaded resonant frequency in Hz	up to 3.7	1 and 3 with mirror	2	1.4
Platform diameter in mm	25	12.5	25	59
Closed-loop Z travel range in $\mu$ m	–	–	30	–
Closed-loop Z resolution in nm	–	–	0.6	–

\*Mechanical angle: The optical beam deflection is twice as high.

# Z Piezo Scanners for Microscopy

Fast and Precise Positioning of Objective and Sample

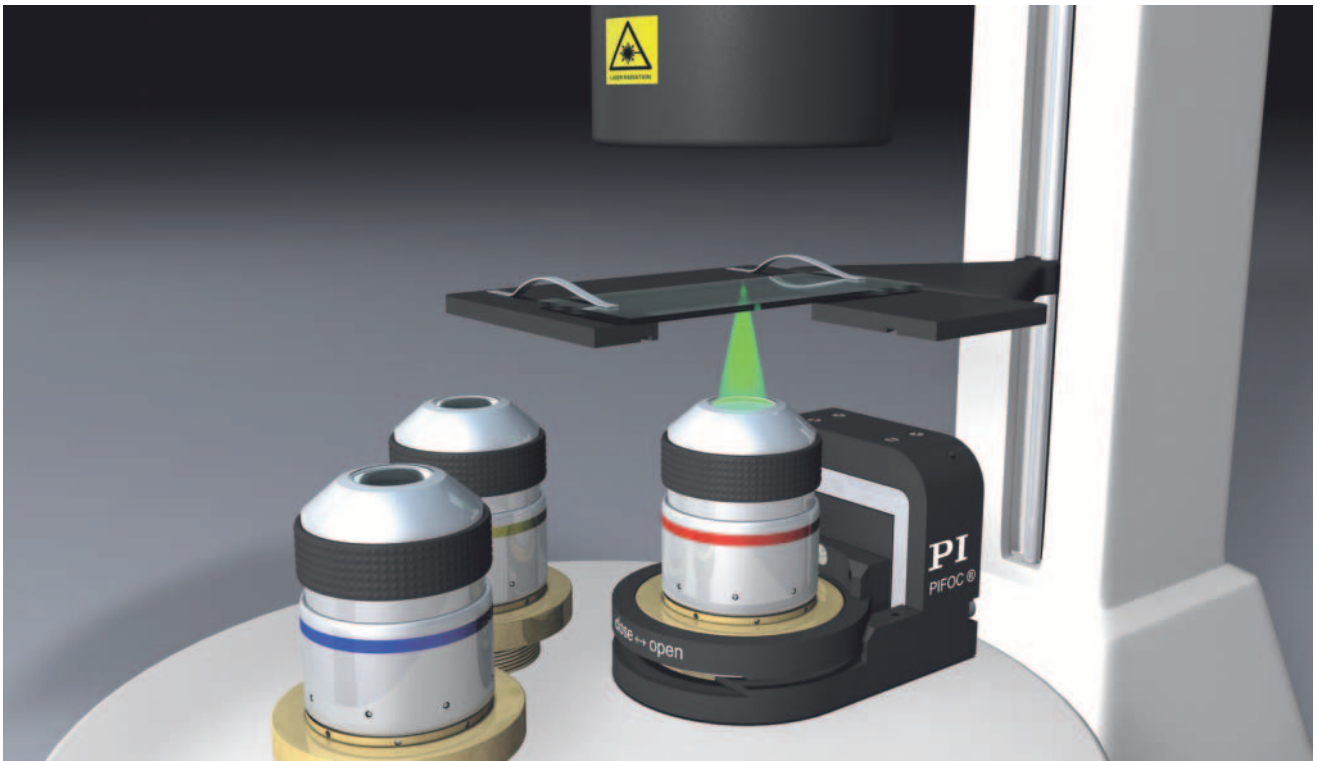

## PIFOC® in Inverse Microscope

PIFOC® objective scanners with piezo drive achieve settling times of up to 10 ms on travel ranges of up to 1 mm. QuickLock threaded inserts allow objectives to be replaced quickly and easily. The figure shows a PIFOC® in an inverted microscope, where the beam is guided onto the sample from below.



**Positioning Tasks in Microscopy**

**Page 46**

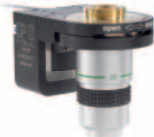

**PIFOC® Objective Scanner with Settling Time in Milliseconds**

**Page 48**

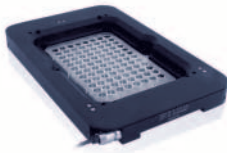

**High-Speed Z Sample Positioning for  
Fast Focus Control and Imaging**

**Page 52**

Microscopic Scanner with Large Clear Aperture



**High-Precision Multi-Axis Sample Positioning with Plnano®**

**Page 54**

Up to 200  $\mu\text{m}$  in XY and XYZ

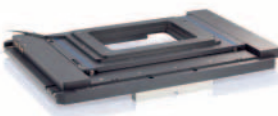

**Precision XY Stages**

**Page 216**

For Microscopy and Inspection Tasks

# Z Positioning Tasks in Microscopy

Depending on the method used, optical microscopy has different positioning stage and scanner requirements for objectives and samples. The application determines which axes are moved as well as their stroke and the required accuracy. The examination of a sample frequently requires many individual scans within a very short period of time, or screenings require high throughputs – both methods have high demands in terms of the systems' dynamics and the smooth behavior during the scan. In addition, their size must fit existing microscopes and must not adversely affect the beam path.

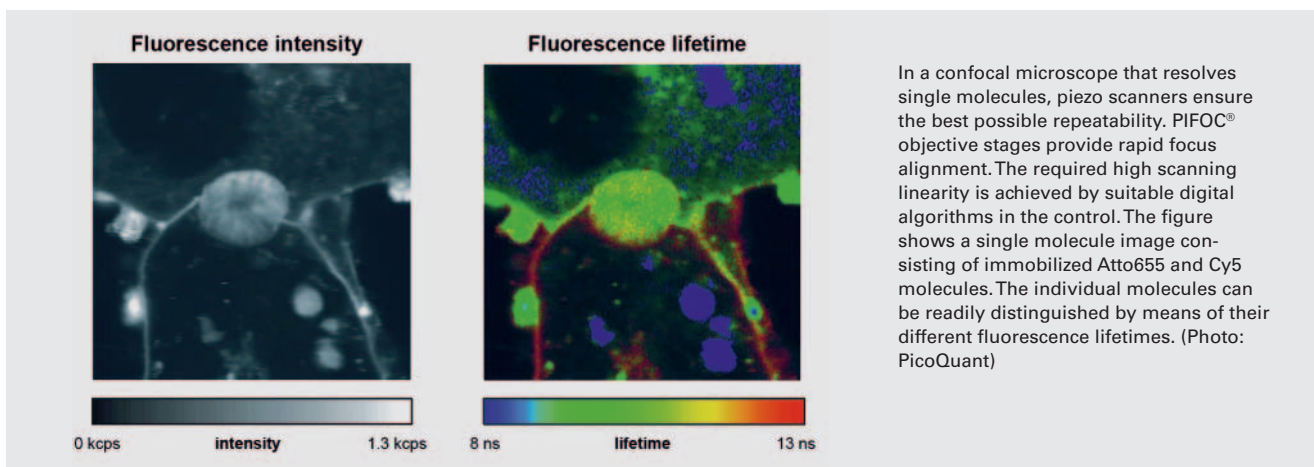

## Z Motion in the Direction of the Optical Axis

For light microscopes, PI products offer fine adjustment in Z for different areas of application, such as fast optical sectioning (Z stacks, image stacks) for 3D processes, confocal or multiphoton microscopy, or autofocus applications and drift compensation. The required step size, for example in Z-stack acquisition, is in the range of the resolution limit of the microscope.

This can in general be achieved by adjusting either the sample or the objective. The high precision and short settling time requirements of the application are identical. With upright microscopy and large or very sensitive samples, the trend is toward adjusting the objective, and with inverted microscopy and small samples toward adjusting the sample.

Systems with travel ranges of up to 500  $\mu\text{m}$ , upon request even up to 2 mm, are available. Even with large objectives, short settling times of approx. 10 ms and thus high throughputs are achieved. Especially for macro-objectives of large numeric aperture (NA), PIFOC® stages are available with a free passage of up to 29 mm with a M32 thread.

PIFOC® objective scanners with their freely exchangeable PI QuickLock threaded inserts can be coupled to the microscope using different thread types and in different angles. The PIFOC® are simply inserted between the revolving nosepiece of the microscope and the objective using the QuickLock. Then the adapter is screwed into the revolving nosepiece and the PIFOC® is fastened in the desired direction. Since the objective positioner itself does not have to be rotated, cabling is no longer an issue.



QuickLock adapters facilitate the mounting of the objective scanner on the microscope

## Objective or Sample Adjustment

Apart from objective stages, several piezo stage series of very low profile and different clear apertures are available for sample adjustment. They are tuned to 3x1" slides or inserts of up to 160 mm x 110 mm. The stroke is up to 500  $\mu\text{m}$ .

For additional tracking or fine adjustment tasks perpendicular to the optical axis, PI offers integrated piezo-based XYZ scanners.

## Autofocus or Externally Specified Target Position

The autofocus signal can be used as control parameter for a constant distance between sample and objective, thus allowing material drift compensation. By changing a single control parameter in the electronics, the piezo stage can be referenced again to the internal sensor and then used, e. g. for Z-stack scans.

### Fields of Application

- Fast picometer-precision 3D surface inspection
- Fast focusing for Z-stack acquisition
- Autofocusing
- Drift compensation down to the nanometer range
- 3-D laser lithography in biotechnology and medical technology

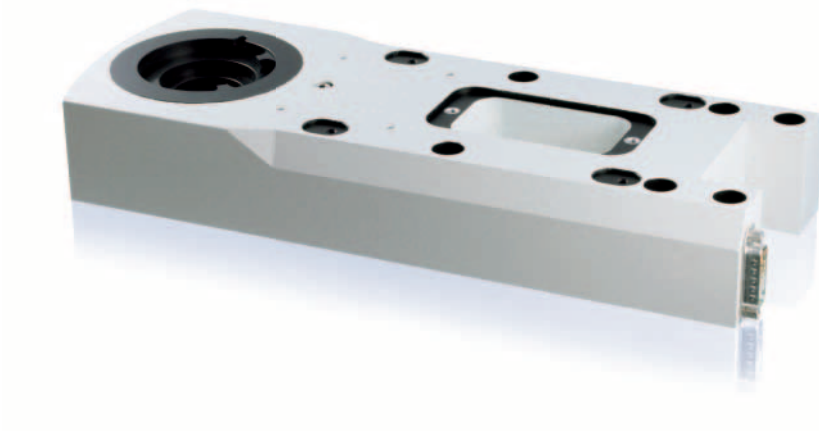

The piezo-based nanostage moves the entire revolving nosepiece containing the different objectives in the direction of the Z axis (Photo: Nikon Instech / PI)

# PIFOC® Objective Scanners

Focusing Microscope Objectives with Nanometer Precision



P-725

## Highlights

- Scans and positions objectives with sub-nm resolution and ms settling time
- Maximum linearity through direct metrology with capacitive sensors
- Minimum objective offset and excellent focus stability through backlash-free parallel flexure guiding
- Outstanding lifetime due to PICMA® piezo actuators
- Longer travel ranges for multiphoton microscopy

## Applications

In addition to all common microscopic processes, the applications also include 3D lithography and industrial surface inspection with white light interferometry (WLI) methods. For all models, a series of QuickLock threaded inserts of different thread dimensions are available, which facilitate mounting. For many models, cost-efficient scanning systems, including digital motion controllers, are available.





P-721



P-725KHDS



P-726

## P-721

## P-725

## P-725K HDS

## P-726

	Cost-efficient, in a system combined with controller		Different travel ranges, in a system combined with controller		Customized model of high dynamics	Very stiff, for heavy objectives
Max. dimensions in mm	40 × 49.5 × 65		46 × 40.5 × 68			Ø 65 × 50.7
Max. objective diameter in mm	39		39		39	M-32
Closed-loop travel range in µm	100		100, 250, 400		400	100
Sensor	capacitive	SGS	capacitive		capacitive	capacitive
Closed-loop resolution in nm	0.7	5	up to 0.65		1.2	0.4
Linearity error in %	0.03	0.2	0.03		0.03	0.02
Repeatability in nm	±5	±10	±5		±5	±3
Push / pull force capacity in N	100 / 20		100 / 20		100 / 20	100 / 50
Unloaded resonant frequency in Hz	580		up to 470		up to 620	1 120
Stiffness in N/µm	0.3		up to 0.23		up to 0.4	3.4
Crosstalk in X,Y in nm	100		20 per 100 µm of travel range		20 per 100 µm of travel range	50

# PIFOC® Objective Scanner

Maximum Dynamics for Revolving Nosepieces

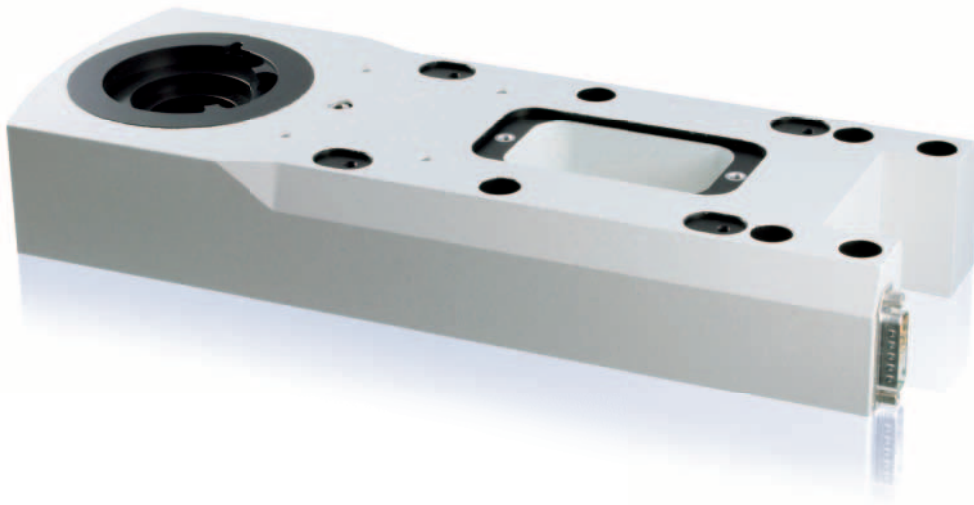

P-721K

(Photo: Nikon Instech/PI)

## Highlights

- Maximum accuracy through direct metrology
- Minimum objective offset and excellent focus stability through backlash-free parallel flexure guiding
- Outstanding lifetime due to PICMA® piezo actuators

## Applications

Different microscopic techniques require different dynamics, travel ranges and flexibility of the piezo Z drives. For high-velocity metrology, as used e.g. in surface and material inspection, focus stability over long travel ranges and high dynamics are crucial. Often one revolving nosepiece can carry different exchangeable objectives. Here special requirements have to be met by the Z scanning method as the different focusing levels have to be approached with higher loads.

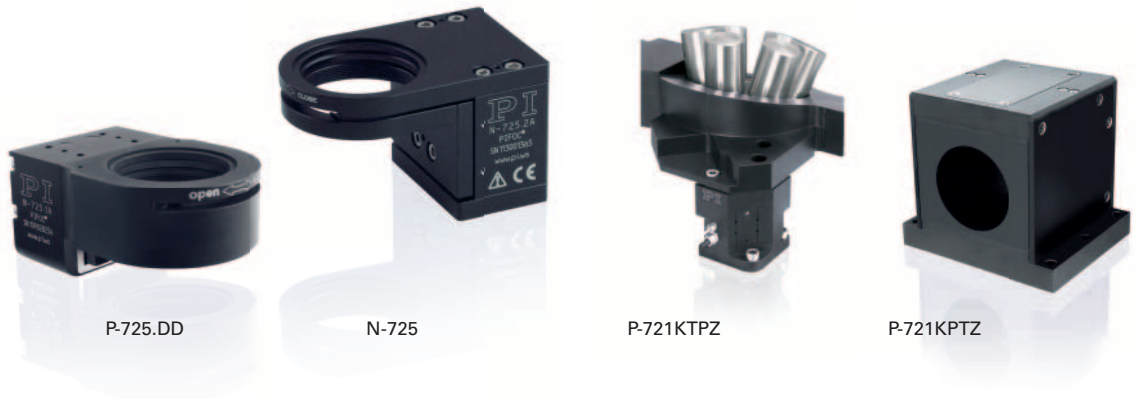

P-725.DD

N-725

P-721K  
TPZ

P-721K  
PTZ

	P-725.DD	N-725	P-721K TPZ	P-721K PTZ
	Very short step-and-settle of below 5 ms with microscope objective	2 mm travel range with piezo linear motor	Customized version for revolving nosepiece	Customized version for revolving nosepiece
Dimensions in mm	52 × 71 × 40.5	52 × 75 × 40	44.5 × 42 × 53	
Clear aperture in mm	34	21		
Closed-loop travel in μm	18	2 000	80	150
Sensor	capacitive, SGS	linear encoder	capacitive	capacitive
Closed-loop resolution in mm	up to 0.2	20	10	2
Linearity error in %	up to 0.04	0.1	0.03	0.03
Repeatability in nm	to ±1.5	±25	±10	±10
Push / pull force capacity in N	100 / 20	10	20	20
Unloaded resonant frequency in Hz	1 180	-	215, fully loaded	410
Stiffness in N/μm	1.5	0.5		
Crosstalk in X, Y in nm	150	<100		

# High-Speed Sample Positioning for Fast Focus Control and Imaging

Microscopic Scanner with Large Clear Aperture



P-737

## Highlights

- High positioning stability of objective slides, including micro titer plates
- Response times of a few milliseconds
- PICMA® piezo actuators for high reliability even in permanently high humidity environments
- Minimum offset and excellent focus stability through backlash-free parallel flexure guiding

## Applications

Creating Z stacks for 3D imaging applications or fluorescence microscopy requires ultra-high precision and dynamics. Piezo-driven sample scanners usually are 10 to 20 times faster than conventional stepper motors. This allows for shorter throughput times and higher data acquisition rates. Also autofocus and drift compensation functions are significantly more performant.



## P-736

## P-736

## P-737

## E-709

	P-736	P-736	P-737	E-709
	Plnano® microscopy scanner	Plnano® microscopy scanner for Nikon and Olympus	PIFOC® focusing stage, perfect mechanical fit with XY stages of leading manufacturers	Digital piezo servo controller
Dimensions in mm	110 × 160 × 20	156 × 237 × 20	138 to 150 × 156 × 27	<ul style="list-style-type: none"> <li>■ Included in delivery of P-736 systems</li> <li>■ Digital interfaces</li> <li>■ Analog input</li> <li>■ Software drivers for LabVIEW</li> <li>■ Supports MetaMorph, µManager, MATLAB</li> <li>■ Wide range of functions, such as function generator, data recorder, macro programming, auto zero, trigger I/O</li> <li>■ Dimensions 160 mm × 96 mm × 33 mm</li> </ul>
Clear aperture in mm	65 × 93 for objective slides	110 × 160 for microtiter plates	90 × 128	
Closed-loop travel in µm	100, 200	220	100, 250, 500	
Step-and-settle at 10% step size in ms, with sample holder (load <100 g)	5	20	24 to 50, depending on travel range	
Sensor	piezoresistive	capacitive, piezoresistive	SGS	
Closed-loop resolution in mm	up to 0.4	1	2.5 to 5	
Recommended load for dynamic operation in kg	0.5	0.5	0.5	

Accessories such as corresponding objective slides available.

# High-Precision Multi-Axis Sample Positioning with PInano<sup>®</sup>

Up to 200  $\mu\text{m}$  in XY and XYZ



P-545 PInano<sup>®</sup>

## Highlights

- Low-profile with 20 mm for space-saving integration in the microscope
- Counter-sunk insertion frames, for unhindered turning of revolving nosepiece
- Large central aperture for objective slides and petri dishes
- PICMA<sup>®</sup> piezo actuators for high reliability even in permanently high humidity environments
- Extendable with manual XY stage for 25 mm  $\times$  25 mm placement

## Applications

Screening applications, confocal microscopy or biotechnology benefit from the sample adjustment in the nanometer range. The corresponding multi-axis controller is included in delivery and can be controlled digitally or via analog signal.



P-545 Plnano®



E-545

## P-545 Plnano® Cap

## P-545.R Plnano®

## P-545 Plnano® TRAK

## E-545

	P-545 Plnano® Cap	P-545.R Plnano®	P-545 Plnano® TRAK	E-545
	Perfectly suited for superresolution microscopy	Cost-efficient design due to piezoresistive sensors	Highly dynamic piezo tracker	Plnano® piezo servo controller, included in delivery of P-545 systems
Clear aperture in mm	90 × 60	90 × 60	90 × 60	<ul style="list-style-type: none"> <li>■ Digital interfaces</li> <li>■ BNC analog input</li> <li>■ Software drivers for LabVIEW</li> <li>■ Supports MetaMorph, µManager, MATLAB</li> <li>■ Wide range of functions, such as function generator, data recorder, macro programming, auto zero, trigger I/O</li> </ul>
Closed-loop travel in µm	200 × 200 × 200	200 × 200 × 200	70 × 70 × 50	
Sensor	capacitive	piezoresistive	piezoresistive	
Closed-loop resolution in mm	1	1	<1	
Recommended load for dynamic operation in kg	0.5	0.5	0.5	
Footprint in mm	150 × 182 to 200 × 217	150 × 182 to 200 × 217	150 × 182 to 200 × 217	

Accessories such as corresponding objective slides available.

# Microscopy Stages

## XY Stages with Clear Aperture

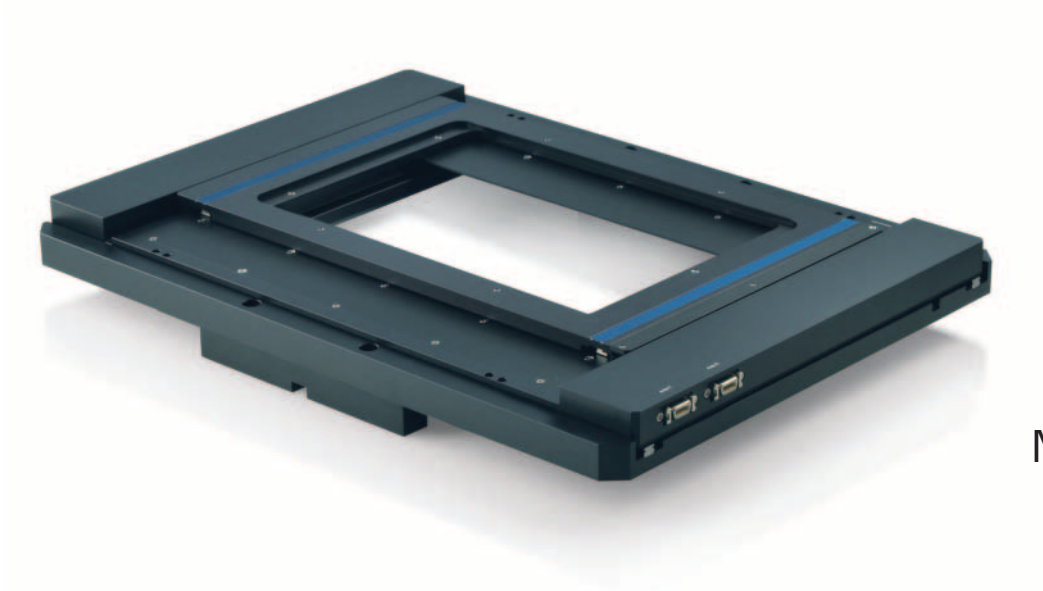

M-687

## Highlights

- Fit on common microscopes from known manufacturers such as Nikon, Zeiss, Leica and Olympus
- Stable positioning
- Low profile for easy integration
- Compact and flat design allows free access to sample
- High constant velocity even at velocities around 10  $\mu\text{m/s}$
- Suitable piezo scanning stages for XYZ and Z sample positioning available

## Applications

For superresolution microscopy, tiling, automated scanning microscopy





M-545



M-686

## M-545

## M-686

## M-687

	M-545	M-686	M-687
	Manual drive via micrometer screws, optional motorization	Dynamic through direct drive equipped with ultrasonic piezomotor	Dynamic through direct drive equipped with ultrasonic piezomotor
Suitable piezo scanning stages	P-545 PInano®	P-563 PIMars, P-541	P-736 PInano®
Clear aperture in mm	140 × 100 for object slides and Petri dishes	78 × 78	160 × 100 for multititer plates
Dimensions in mm	230 × 240 × 30	170 × 170 × 32	400 × 297 × 48 (for Nikon Eclipse Ti) 400 × 237 × 36 (for Olympus IX2)
Travel range in mm	25 × 25	25 × 25	135 × 85 (for Nikon Eclipse Ti) 100 × 75 (for Olympus IX2)
Design resolution in μm	0.046 (motorized)	0.1	0.1
Min. incremental motion in μm	1 (motorized)	0.3	0.3
Unidirectional repeatability in μm	2	0.3	0.3
Max. velocity in mm/s	1.5	100	120
Load capacity in N	50	50	50
Recommended controller	motorized system including controller and joystick	C-867 PLine® motion controller double-axis	system including controller and joystick

Stepper motor resolution controller-dependent

# Precision XY Stages

Scanners for Inspection and Microscopy Tasks

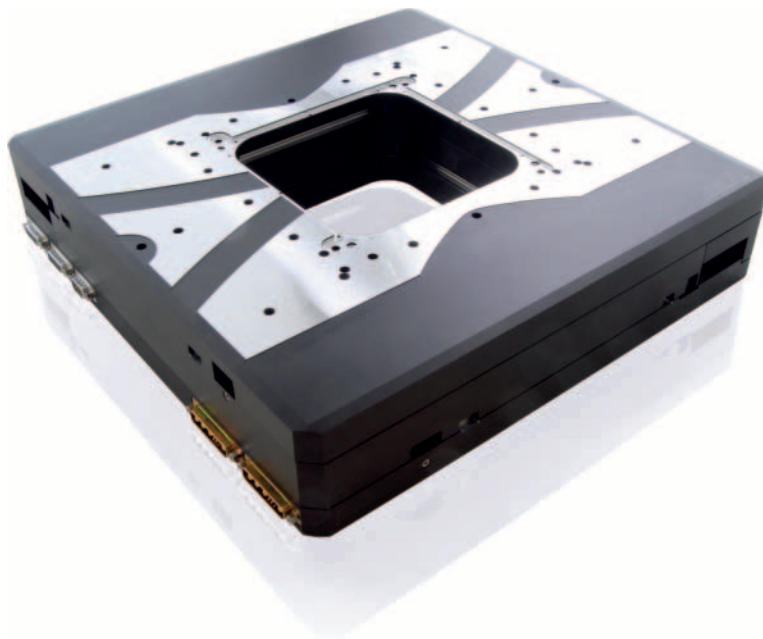

MCS

## Highlights

- Stable platforms equipped with electric motors
- With clear aperture suitable for transmitted light and incident light microscopy
- Optionally with linear encoder
- Minimum flatness error

## Applications

The guiding and position accuracy of these microscopy XY stages is required in particular in industrial metrology. Its areas of applications include industrial surface measurement technologies such as topology measurements on workpieces and optics or structural measurements on semiconductor wafers. Their high loads allow further axes, e.g. those of rotary stages, Z modules and tilt stages to be mounted on the platform.

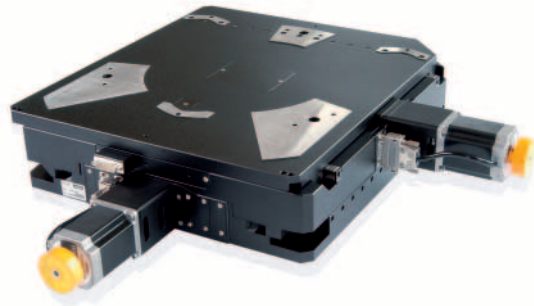

CS-430



M-880

## MCS

## CS-430

## M-880

	MCS	CS-430	M-880
Dimensions in mm	380 × 380 × 80	430 × 430 × 100	600 × 600 × 105
Clear aperture in mm	150 × 150	–	Ø 160
Travel range in mm	102 × 102 205 × 205 / 305 × 305 on request	350 × 300	20 × 20 $\theta_z: 8^\circ$
Design resolution in $\mu\text{m}$	0.005 to 0.2	to 0.05	–
Min. incremental motion in $\mu\text{m}$	to 0.005	0.1 to 0.5	–
Unidirectional repeatability in $\mu\text{m}$	0.2	0.1 to 0.5	0.5
Crosstalk in $\mu\text{rad}$	$\pm 40$ / $\pm 20$	$\pm 80$	–
Max. velocity in mm/s	35 to 300	100	20
Load capacity in N	200	300	1500 (holding force)
Push / pull force in N	80 to 200	110	200
Motor type	2-phase stepper motor, DC motor, linear motor	2-phase stepper motor	DC-motor ActiveDrive
Recommended controller	SMC controller	SMC controller	system including controller

# Precision Motion Control

## Piezo Amplifiers and Controllers for Nanopositioning

### Selection Criteria for Piezo Amplifiers and Controllers from PI

The decision for a piezo controller depends on the specific application situation. Diverse criteria, such as limited installation space, the number of axes or the type of control, determine which amplifier or controller is best suited for the application.

Your Application Requires...	Which is the Suitable Controller?
Frequent change in load or change of operating mode	Change parameters simply using software: Any digital controller from PI, also E-609 series
Cost-effectiveness	Digital: E-709 or E-609; analog: E-610, E-625, E-621
3 to 6 channels	Digital: E-725, E-712; analog: E-500, E-612
More than 6 channels	Networkable controllers, such as E-621, E-625, E-665; modular controllers, such as E-712
High resolution	Digital high-end solutions from PI, such as E-753, E-712, E-725; any analog controller from PI
Highest dynamic linearity	Digital high-end solutions from PI with DDL option
Long-term stability (thermal)	All piezo controllers und drivers from PI
High linearity / accuracy	Any digital controller from PI, also E-709 series: Digitization for 5 <sup>th</sup> order polynomials, additional DDL option
Control with analog input signal	Any analog controller from PI E-709, E-609, E-753, E-725 digital servo controllers or E-712 with analog IN option
Real-time commands	Digital with PIO Option; SPI interface, TCP/IP for transfer rates of up to 1 kHz; all controllers via analog I/O
Control in real time or with high servo rates	Any analog controller from PI; E-712, E-753, E-725
Fast, non-periodic motion in several axes, tracking	E-712
Virtual axes multi-axis synchronization	Digital multi-axis controller, such as E-712, E-725
Digital communication interfaces; user-defined periodic motion profiles; data recorder	Any digital controller from PI; E-625, E-621, E-665; modular controller with E-517 digital control unit
Stand-alone functionality with macros	Modular controller with E-517 digital control unit
Trigger I/Os	Any digital controller from PI; and also E-625, E-621, E-665; modular controller with E-517 digital control unit



## Digital and Analog Controllers for Piezo Nanopositioning Stages

Page 58



## OEM Piezo Amplifier Modules

Page 64

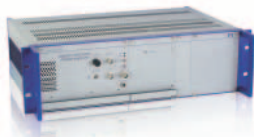

## Piezo Drivers / Controllers with High Dynamics

For Piezo Actuators with a Control Voltage of up to 1 000 V

Page 66



## Piezo Axes with Special Output Voltage

Pre-Configured Multi- and Single-Axis Controllers

Page 68



## Digital Controllers for Piezomotors

System Optimization and Ease of Operation: Plug-and-Play

Page 70

# Digital Controllers for Single-Axis Piezo Nanopositioning Stages

System Optimization and Ease of Operation



E-753

## Highlights

- Digital controller with linearization algorithms, parameter settings via software and notch filter for suppression of oscillations
- Servo-control for capacitive, SGS and PRS sensors
- ID chip support for automatic calibration of the controller to the piezo mechanics
- Wave generator, data recorder, auto zero, trigger I/O
- Additional high-bandwidth analog control input / sensor input

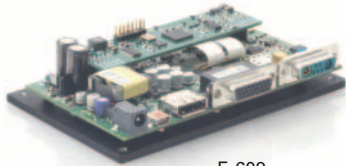

E-609,  
E-709 OEM version



E-709 bench-top device



E-709.CHG

## E-709 E-609

## E-709. CHG

## E-753

	Cost-efficient digital piezo controller, for universal use	Digital high-performance controller for high dynamics	High-efficiency processor for linearization algorithms of higher order, 24 bit D/A transducer
Interfaces / Communication	Analog, USB, digital RS-232, fast serial interface with up to 25 Mbit/s. E-609 OEM piezo controller available with digital controller and analog input	Analog, USB, digital RS-232, fast serial interface with up to 25 Mbit/s	Analog, Ethernet (TCP/IP) interface for remote control capability, RS-232
Sampling rate, servo-control	10 kHz	10 kHz	25 kHz
Supported sensor type	capacitive, SGS, PRS	capacitive	capacitive
Output voltage range in V	-30 to +130	-30 to +130	-30 to +135
Peak current in mA	100	500	110
Average current in mA	50	160	40
Amplifier bandwidth, small signal in kHz	50	50	50
Dimensions in mm	160 × 96 × 33	320 × 150 × 80	264 × 125 × 48

# Digital Controllers for Single-Axis Piezo Nanopositioning Stages

Cost-Efficient with Versatile Interfaces



E-625

## Highlights

- For high-dynamics applications of several kHz to static applications
- Servo-control for capacitive and SGS sensors
- Analog interfaces
- Optional digital interface





E-610



E-621



E-665

## E-610

## E-621

## E-625

## E-665

	Universal piezo control, OEM module	Piezo controller module, board for up to 12 axes in 19" rack	E-621 digital piezo controller as bench-top device	High-performance piezo controller for high dynamics
Interface / communication	analog	digital interface with additional digital functions, such as data recorder, wave generator, etc.	digital interface with additional digital functions, such as data recorder, wave generator, etc.	digital interface with additional digital functions, such as data recorder, wave generator, etc.
Supported sensor type	capacitive, SGS	capacitive, SGS	capacitive, SGS	capacitive, SGS
Output voltage range in V	-30 to 130	-30 to 130	-30 to 130	-30 to 130
Peak current in mA	180	120	120	360
Average current in mA	100	60	60	120
Dimensions in mm	100 x 160	100 x 160	105 x 205 x 60	236 x 88 x 273

# Controllers for Multi-Axis Nanopositioning Stages

For 3 and More Axes



E-712.6CDA

## Highlights

- Versatile solutions for all piezoelectric drives from PI
- For high-dynamics applications of several kHz to static applications
- Servo-control for incremental, capacitive and SGS sensors
- Digital controller for highest system optimization and ease of operation with ID chip support for automatic calibration of the controller to the piezo mechanics
- Analog controller system with digital interface submodule for wave generator, data recorder and display



E-500



E-725



E-712

## E-500

## E-725

## E-712

	E-500	E-725	E-712	Available Options for E-712
	Modular controller with analog driver, up to three axes, optional with digital interface and additional digital functions, such as data recorder, wave generator, etc.	3-axis digital controller	Freely configurable, modular digital controller for three axes and more	<b>Available Options for E-712</b> <ul style="list-style-type: none"> <li>■ Amplifiers for piezo nanopositioners and piezomotors</li> <li>■ Pre-configured 3- and 6-axis controllers</li> <li>■ Additional interfaces: Analog, parallel I/O</li> <li>■ Linearization algorithms of higher order</li> <li>■ Real-time operation system</li> <li>■ Digital sensor-signal transmission over longer travel ranges</li> </ul>
Interfaces / Communication	Ethernet (TCP/IP), USB, RS-232, IEEE 488	Ethernet (TCP/IP) USB, RS-232	Ethernet (TCP/IP) USB, RS-232	
Sampling rate, servo-control	25 kHz (with digital interface)	20 kHz	20 to 50 kHz	
DAC/ADC resolution in bit	24/18	24	20	
Supported sensor type	capacitive, SGS	capacitive	capacitive, PISeca capacitive, incremental	
Output voltage range in V	-30 to 130 to 1 100	-30 to 135	-30 to 135	
Peak current in mA	140 to 10 000	190	140	
Average current in mA	40 to 215 (different performance classes of piezo amplifier modules)	120	60	
Amplifier bandwidth, small signal in kHz	50	50	15	
Dimensions	9.5 or 19" casing	263 × 89 × 302 mm <sup>3</sup>	9.5 or 19" casing	

# OEM Piezo Amplifier Modules

---

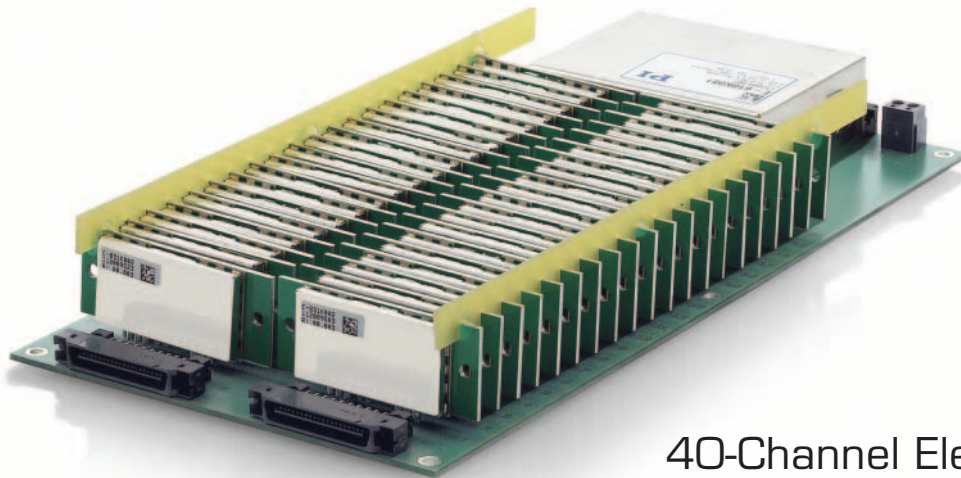

40-Channel Electronics  
Based on E-831

## Highlights

- Individual multi-channel solutions can be designed on the basis of these piezo amplifiers
- Separate power supply (DC/DC converter) for one or several amplifier modules
- Bench-top versions for fast start-up of piezo actuators in applications with very low dynamics

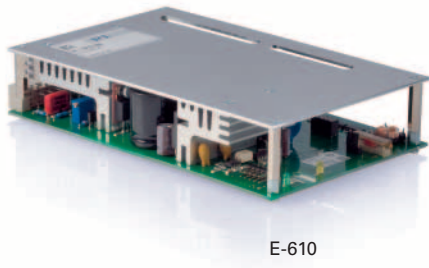

E-610



E-831



E-660, E-462  
OEM plug-in module

## E-610

## E-831

## E-660

## E-462

	E-610	E-831	E-660	E-462
	Universal piezo controller, OEM module, optionally with servo-loop for capacitive or SGS sensors	Miniature modules	For quasi-static applications	For quasi-static applications
Output voltage range in V	-30 to 130	-30 to 130	5 to 110	10 to 1000
Peak current in mA	180	100 to 250	20	0.5
Average current in mA	100	50 to 100	10	0.3
Amplifier bandwidth, small signal in kHz	up to 30	3.5 to 15	quasi-static	quasi-static
Noise, 0 to 100 kHz in mV <sub>rms</sub>	0.5 to 1.6	<0.15 to 0.8	5	50
Available designs	Eurocard	60 × 28 × 6 mm <sup>3</sup>	160 × 90 × 60 mm <sup>3</sup> bench-top device or plug-in module for circuit board	205 × 150 × 73 mm <sup>3</sup> bench-top device or 67 × 38 × 20 mm <sup>3</sup> OEM plug-in module
Power source	DC/DC transducer, already integrated	optional with integrated DC/DC transducer	DC/DC transducer already integrated	DC/DC transducer already integrated

# Piezo Drivers / Controllers with High Dynamics

For Piezo Actuators with a Control Voltage of up to 1 000 V

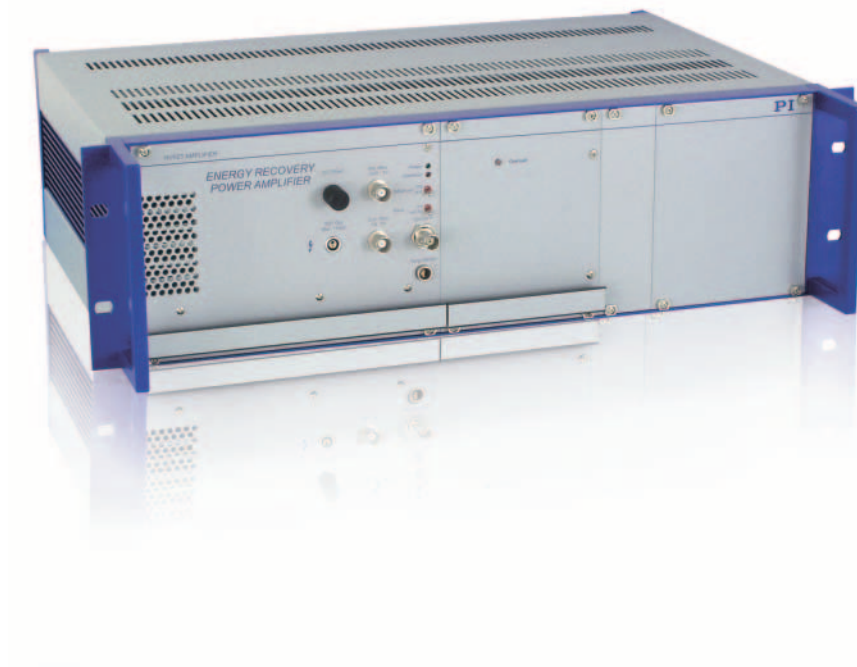

E-481

## Highlights

- High dynamics, also for piezo actuators with high electrical capacitance
- Integrated overtemperature protection prevents overheating of the piezo actuator
- Additional options: Servo-control for long-term stability, digital interfaces
- For dynamic scanning in continuous operation, fast switching, active vibration damping



E-618



E-617



E-506

E-618

E-617

E-506

E-481

E-482

	Short rise times due to high piezo charging current of up to 20 A	Low power consumption due to switched control principle with energy recovery	High linearity of piezo displacement due to charge control, deviation <2%	Low power consumption due to switched control principle with energy recovery
Output voltage range in V	-30 to 130	-30 to +130	-30 to 130	0 to +1100, bipolar selectable
Peak current in mA	20 (<0.3 ms)	2 (<5 ms)	2 (<2.5 ms)	0.5 to 6 (<5 ms)
Average current in mA	0.8 (>0.3 ms)	1 (> 5 ms)	0.2	0.1 to 2
Amplifier bandwidth, small signal in kHz	up to 15	3.5	15	several kHz even with high actuator capacitance
Noise, 0 to 100 kHz in mV <sub>rms</sub>	200 mV <sub>pp</sub> / 24 mV <sub>rms</sub> (without load), 2 mV <sub>rms</sub> (1 μF)	<30 mV <sub>rms</sub> <100 mV <sub>pp</sub>	<0.6 mV <sub>rms</sub>	<25 to 300 mV <sub>rms</sub>
Available designs	9.5 or 19" rack unit	design for top-hat rail mounting or E-504 module for E-500 controller system	plug-in module for E-500 controller system	19" rack unit. E-421, E-470 piezo controllers for 1 or 2 axes

# Piezo Axes with Special Output Voltage

Pre-Configured Multi- and Single-Axis Controllers



E-413.00

## Highlights

- Special piezo actuators and piezo scanners require specific output voltages:  
Different controllers and drivers for tip/tilt mirrors, multi-axis scanners, bimorph piezo benders, DuraAct and shear actuators
- Internal coordinate transformation of tilt angle for parallel-kinematic multi-axis design
- Large variety of designs, bench-top devices, rack units, individual modules, OEM versions



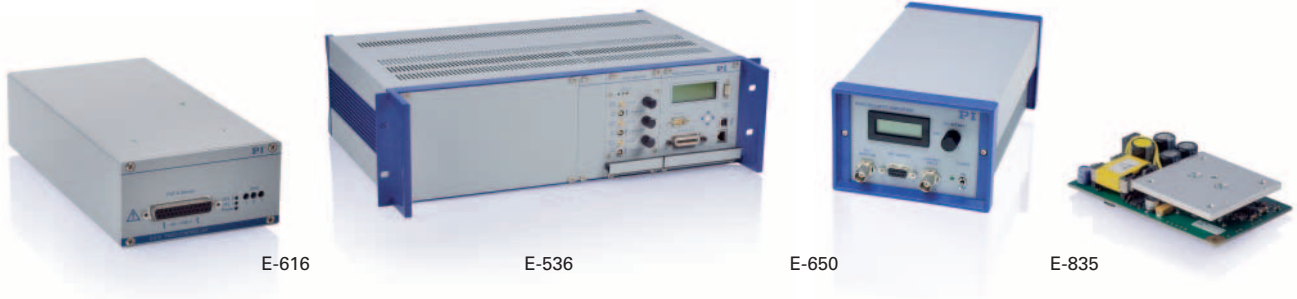

E-616

E-536

E-650

E-413

E-651

E-835

	E-616	E-536	E-650 E-651	E-413 E-835
	For tip/tilt mirror systems with tripod or differential drive	For PicoCube® 3-axis piezo scanner	For PICMA® Benders with or without servo-control	Bipolar output voltage, for DuraAct or shear actuators
Supported sensor type	SGS	capacitive	SGS or open-loop	–
Output voltage range in V	-20 to +120	-250 to +250	0 to 60	350 to 500 V voltage range
Peak current in mA	100	100 to 200	up to 300 open-loop for maximum dynamics	100
Average current in mA	50	15 to 30	<100	<50
Bandwidth in kHz	3 (small signal)	2 to 10 (small signal)	6 (large signal)	up to 4 (small signal)
Available designs	bench-top device or eurocard rack unit	19" rack, optional with digital interface	bench-top device or OEM plug-in module	bench-top device or compact OEM designs

# Digital Controllers for Piezomotors

System Optimization and Ease of Operation: Plug-and-Play



E-871

## Highlights

- Extensive software support, e.g. for LabVIEW, shared libraries for Windows and Linux.  
Data recorder, e.g. for position values
- Processing of incremental sensors
- Analog I/O, e.g. for connection to joystick, and digital I/O for automation applications
- Integrated drivers, optimized for the corresponding drive type, e.g. with auto-resonant ultrasonic frequencies or concerted displacement of shear and longitudinal actuators
- Alternative: Driver electronics without integrated control for designing an external servo loop



E-755



E-861



C-867

## E-755

## E-861

## E-871

## C-867

	E-755	E-861	E-871	C-867
	For NEXLINE® piezo stepping drives	For NEXACT® piezo stepping drives	For PIShift piezo inertia drives	For PILine® ultrasonic drives
Special features	linearization with polynomials for perfect linearity of motion, deviation approx. 0.001% over the entire travel range of the NEXLINE® nanopositioning stage	supports all motion modes: Point-to-point-motion, analog mode for nanometer-precise positioning at target position. Non-volatile macro memory	supports all motion modes: Point-to-point-motion, analog mode for nanometer-precise positioning at target position. Non-volatile macro memory	supports all motion modes: Point-to-point-motion, slow motion at $\mu\text{m/s}$ , precise step-and-settle. Non-volatile macro memory
Interfaces / Communication	RS-232	USB, RS-232	USB, RS-232	USB, RS-232
Multi-axis control	up to 16 units via daisy chain. E-712 modular multi-axis controller for different drive modes available	up to 16 units via daisy chain. E-712 multi-axis controller	up to 16 units via daisy chain	up to 16 units via daisy chain. 2-axis controller available
Open-loop designs / drive electronics	open-loop designs available	E-862 OEM drive electronics available	E-870 OEM drive electronics available	OEM version in euro-card format or C-872 OEM driver electronics available

# Nanometrology

## High Precision for Nanopositioning Technology



PIMag 6D, the positioning system based on magnetic levitation: The passive platform levitates on a magnetic field which actively guides it. In this way, objects can be moved linearly or rotationally on a plane with a previously unattained guiding accuracy. The six-axis motion is controlled by a 6D sensor, that combines high-resolution capacitive and incremental sensors

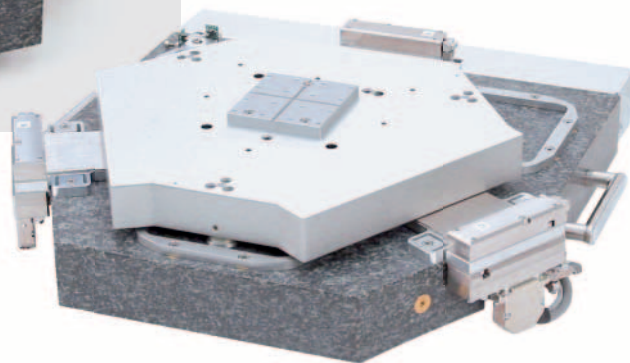



---

**Capacitive and Incremental Sensors**  
Nanometrology in PI Piezo Nanopositioning Systems

---

**Page 74**

# Capacitive and Incremental Sensors

## Nanometrology in PI Piezo Nanopositioning Systems

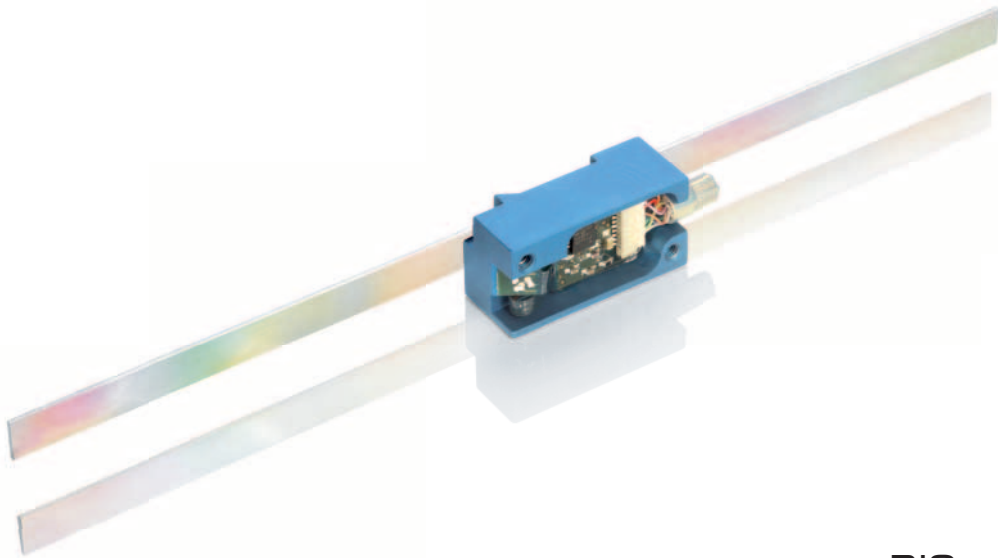

PIOne Sensor  
Head and Scale

## Highlights

- Noncontact distance measurement
- For applications with highest precision requirements
- Direct position measurement compensates for mechanical deviation: Direct metrology

## Applications

For its reference-class nanopositioning stages, PI uses noncontact position measurement methods. The most important specifications for selecting a suitable method are linearity, resolution (sensitivity), stability, bandwidth and, last but not least, the costs. In addition, it is important that the selected method is capable of directly measuring the platform's motion, so that any position change of the platform is captured by the controller relatively to the base body. Here, accuracies in the sub-nanometer range are possible.



D-015



D-510

D-015  
D-050  
D-100

D-510  
PISeca

D-711  
PIOne

	Capacitive sensors with resolution in the sub-nanometer range	Single-electrode capacitive sensors with excellent resolution	Incremental sensor with interferometric measuring principle for nanopositioning
Area of application	integrated in the piezo nanopositioning stages from PI For use in UHV up to $10^{-9}$ hPa	easy integration, available as individual product for designing an external servo loop with E-852 electronics Also for vibration measurement	integrated in PI nanopositioners with travel range >1 mm
Resolution	0.0005% of the measurement range, typically 0.5 nm to 10 pm	0.001% of the measurement range, typically 1 to 5 nm	up to 20 pm RMS; 0.12 nm peak-to-peak
Bandwidth	10 kHz	10 kHz	1 MHz
Measurement range	up to 2000 $\mu$ m	20 to 500 $\mu$ m, millimeter on request	10 to 130 mm, depending on the scale
Linearity error	up to 0.01% of the measurement range, typically 10 to 50 nm	up to 0.1% of the measurement range, typically 100 to 500 nm	<20 nm
Operating temperature range	-20 to +80°C	-20 to +100°C	10 to +50°C
Material	aluminum other, e.g. Invar on request	aluminum other, e.g. Invar on request	mixture, glass scale
Dimensions sensor in mm	15 x 8 x 4 to 20 x 20 x 5	$\varnothing$ 8 to 20 x 30	23 x 12 x 9.5

# Nanopositioning Technology

---

---

## **Piezo Actuators as Drives for Nanopositioning**

**Page 77**

Highly Reliable PICMA® Piezo Actuators – Nanopositioning with Piezomotors over Long Travel Ranges: PiezoWalk®, PILine®, PIShift

---

## **Excellent Guiding Accuracy through Flexure Joints**

**Page 79**

No Wear – Flexures as Levers – Sub-Nanometer Accuracy

---

## **Parallel Kinematics Optimizes Motion in Multiple Axes**

**Page 80**

Parallel or Serial Multi-Axis Design

---

## **Kinematics of Multi-Axis Tip/Tilt Systems**

**Page 81**

Tip/Tilt System with Tripod Piezo Drive – Tip/Tilt System with Differential Piezo Drive (Tetrapod) – Dynamics of a Piezo Tip/Tilt Mirror

---

## **Use in Vacuum**

**Page 83**

Vacuum Classification at PI

---

## **Special Ambient Conditions**

**Page 83**

Magnetic Fields – Low Temperatures

---

## **Sensor Technology for Nanopositioning Technology**

**Page 84**

Maximum Accuracy through Direct Metrology – Capacitive Sensors – PIONe Linear Encoders: Small and Picometer Resolution – Indirect Position Measurement with Strain Gauge Sensors – Direct Parallel Metrology: Multi-Axis Measurements using a Fixed Reference

---

## **Precision Motion Control**

**Page 88**

Control Electronics Optimizes System Properties – Advantages and Disadvantages of Position Control – Resolution with Closed-Loop and Open-Loop Control – Flexible Controllers to Match the Mechanics – Controller Tuning

---

## **Digital Controllers Provide Precision, Dynamics and Ease of Operation**

**Page 91**

Linearization of the Electronics – Controllers and Controlling Methods – Linearization of the Mechanical System – Dynamic Linearization – Additional Functions of Digital Controllers

---

## **Motion Control Software**

**Page 93**

Universal Command Set – Host Software PIMikroMove® for Fast Start-Up

---

## **Service**

**Page 96**

Scope of Delivery – Customization – Updated Firmware, Software and User Manuals

---

## **Glossary**

**Page 97**

---



# Piezo Actuators as Drives for Nanopositioning



Low-profile two-axis piezo scanner

## Piezo actuators have excellent drive properties:

- The motion of piezo actuators is based on solid-state effects, which makes their resolution in general unlimited
- Their stiffness is very high, enabling high force generation by piezo stepping drives
- Their rapid response time in the micro-second range is a result of their high resonant frequency of several hundred kilohertz
- The available travel range is a few hundred micrometers

The motion of piezo actuators is not straight. To avoid lateral migration, a guiding system is required. In piezo stages manufactured by PI, friction and backlash-free flexure joints ensure high-stiffness guiding and optimum travel accuracy. They also enlarge the travel range to the millimeter range.

Solid state effects in the piezoelectric material account for a nonlinear motion with hysteresis. To achieve the excellent stability, linearity and repeatability required for nanopositioning, a position control is used.

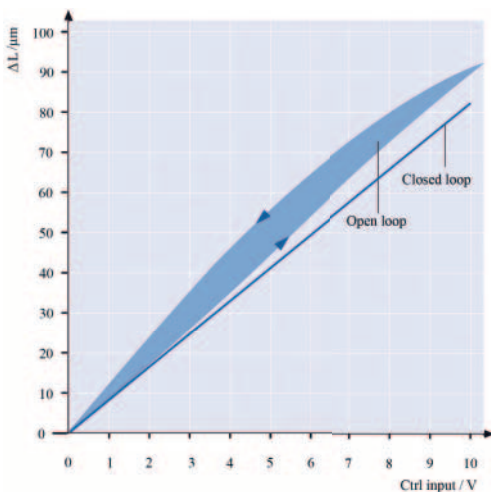

The position control eliminates the nonlinear behavior of the piezo actuator. The possible travel range, however, is longer without position control

## Highly Reliable PICMA® Piezo Actuators

PICMA® piezo actuators from PI are the only monolithic, multilayer piezo actuators in the world which are completely encapsulated in a ceramic insulation layer. Decades of experience with PICMA® series in various applications show that the lifetime has been increased by at least a factor of 10 compared to conventional, polymer-coated, multilayer piezo actuators. In lifetime tests, more than 100 billion cycles without a single failure have been demonstrated. The PICMA® technology is patented.

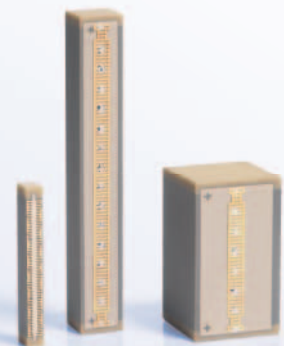

Due to their ultra-high performance and reliability, PICMA® piezo actuators with all-ceramic insulation were chosen for tests carried out by NASA on Mars

**Nanopositioning with Piezomotors over Long Travel Ranges: PiezoWalk®, PLine®, PIShift**

For travel ranges over 1 mm, PI uses piezomotors as drives, which also feature high stiffness and resolutions in the nanometer range. Piezomotors do not generate magnetic fields nor are they affected by them.

Piezomotors are optimally suited for using the specific properties of piezo actuators to achieve longer travel ranges. Adapted to the required force and velocity development, PI provides a series of different piezomotor technologies, each of which focuses on different features.

- Piezomotor Properties**
- Self-locking when at rest with maximum holding force
  - Variable travel ranges
  - Nanometer-precision resolution
  - Easy mechanical integration
  - Different technologies optimized for high velocities or for high forces

Piezo stack actuators in multi-layer or pressing technology	PiezoWalk® piezo stepping drive	PLine® ultrasonic piezomotor	PIShift piezo inertia drive
Sub-nanometer resolution	Sub-nanometer resolution	Sub-micron resolution	Sub-nanometer resolution
Fast response within a few microseconds	Velocity up to 10 mm/s High-dynamics scan mode	Very high operating frequency Noiseless drive High velocity of up to several 100 mm/s	Very high operating frequency Noiseless drive Velocity of more than 10 mm/s
Travel ranges of up to approx. 300 µm directly and 2 mm with lever amplification	Long travel ranges, only limited by the runner length	Long travel ranges, only limited by the runner length	Long travel ranges, only limited by the runner length
High stiffness Force generation of up to 100 kN	Very high forces of up to 800 N (NEXLINE®) Self-locking at rest	Forces up to 40 N self-locking at rest	Forces up to 10 N self-locking at rest
Control via analog voltage Voltage range 150 V (PICMA® multilayer actuators), 1 100 V (PICA high-load actuators)	Multi-actuator drive generates stepping motion Voltage range 55 V (NEXACT®), 500 V (NEXLINE®)	Single-actuator drive Control via high-frequency alternating voltage (sinus) Voltage range 120 V, 200 V. Minimotors substantially lower	Single-actuator drive Control via high-frequency alternating voltage (modified sawtooth) Voltage range <48 V
<b>Ideal for:</b>			
<ul style="list-style-type: none"> <li>■ Nanometer-precise positioning with high dynamics</li> <li>■ Lever-amplified and guided systems for                             <ul style="list-style-type: none"> <li>_ Piezo scanner</li> <li>_ Fine adjustment</li> <li>_ Force generation</li> <li>_ Active vibration insulation</li> </ul> </li> </ul>	<ul style="list-style-type: none"> <li>■ Nanometer-precise positioning</li> <li>■ Quasi-static applications at high holding force</li> <li>■ Travel ranges of up to a few mm</li> <li>■ Coarse and fine adjustment</li> <li>■ Force generation</li> <li>■ Active vibration insulation</li> <li>■ Operation at constantly low velocity</li> </ul>	<ul style="list-style-type: none"> <li>■ Positioning with sub-µm accuracy</li> <li>■ Fast step-and-settle</li> <li>■ Scan mode with high velocities</li> <li>■ Operation at constantly low velocity</li> </ul>	<ul style="list-style-type: none"> <li>■ Nanometer-precision positioning stable over a prolonged period</li> <li>■ Quasi-static applications at low to medium holding force</li> </ul>

# Excellent Guiding Accuracy through Flexure Joints

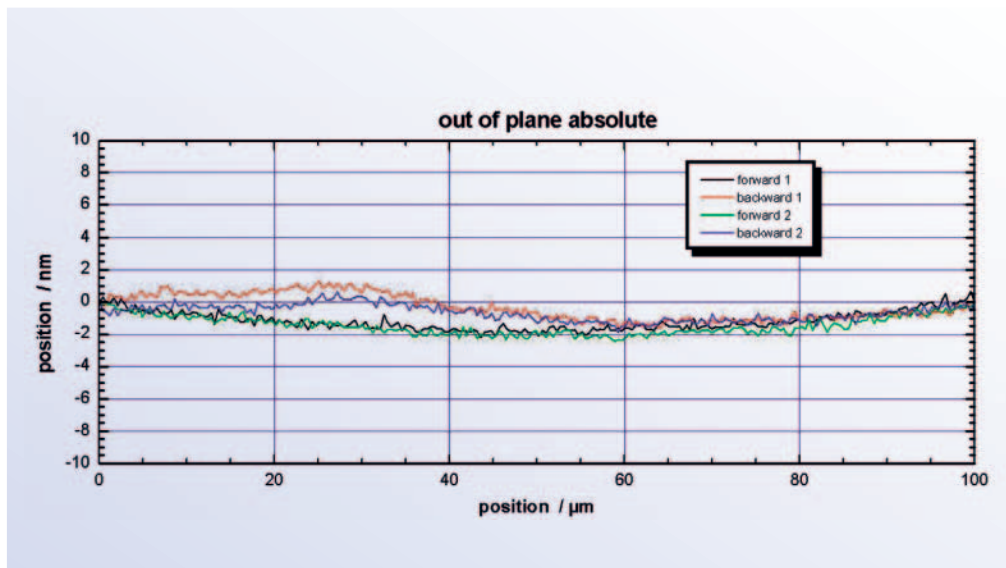

A piezo stage with integrated flexure guide achieves a guiding accuracy of only a few nanometers or microradians and excellent flatness

Flexure guides from PI have proven their worth for nanopositioning tasks down to 2 nm.

The motion of a flexure joint is based on the elastic deformation of a solid. Therefore, there is no static, rolling or sliding friction.

### No Wear

Their advantages are the high stiffness, load capacity and wear-resistance. Flexures are maintenance-free, can be manufactured from nonmagnetic materials, require no lubricants or consumables and hence also function in a vacuum without any problem.

### Flexures as Levers

The displacement of a piezo actuator can also be multiplied by integrating a lever mechanism. The actuator is mechanically integrated in a flexure joint in such a way that the travel range is extended to up to 2 mm. Since simple lever structures lose a considerable amount of guiding accuracy and stiffness, however, the design requires much more complex geometries.

### Sub-Nanometer Accuracy

Flexures allow motions with extremely high path accuracy. In order to compensate for height or transversal offset, PI uses special multi-link flexure guides. These guiding systems, which are implemented in most nanopositioning systems from PI, allow a flatness and straightness in the sub-nanometer or microradian range.

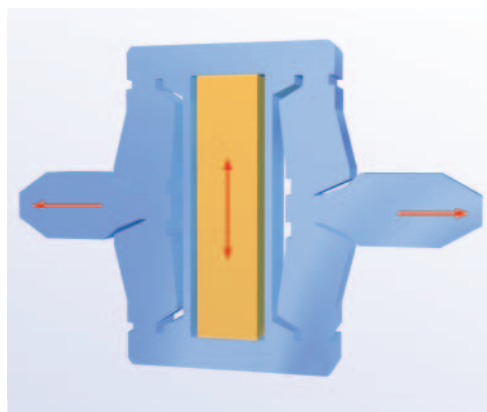

This lever mechanism with flexure guides transforms the actuator travel range (vertical) to an even, straight motion (horizontal)



The deformation of the flexure guides is checked with FEM stress simulations

# Parallel Kinematics Optimizes Motion in Multiple Axes

In a parallel-kinematic multi-axis system, all actuators act directly on one moving platform. This means that all axes move the same minimized mass and can be designed with identical dynamic properties. Parallel-kinematic systems have additional advantages over

serially stacked or nested systems, including more-compact construction and no cumulative error or weight from the different axes. Parallel-kinematic systems can be operated with up to six degrees of freedom with low inertia and excellent dynamic performance.

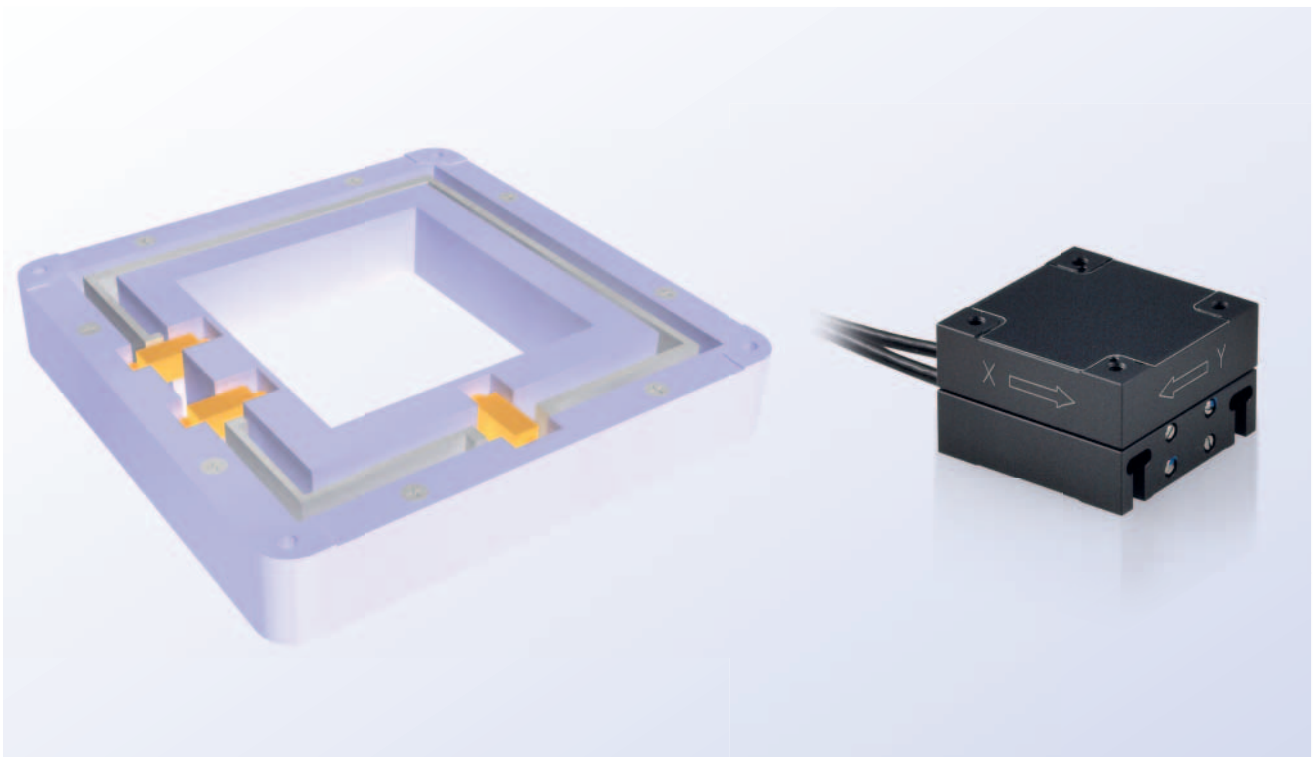

In a parallel-kinematic structure, all drives act on the same moving platform so that the individual axes have the same dynamic behavior. Consequently, higher dynamics and higher scanning frequencies, improved guiding accuracy, repeatability and stability can be achieved than with serial axes systems

A serial multi-axis system, whether nested or stacked, assigns exactly one direction of motion to each actuator and each sensor. The stage axes carry the next mounted axis so that the dynamic properties deteriorate and the overall stiffness decreases. Moreover, the runouts of the individual axes add up to a lower accuracy and repeatability. Serial-kinematic systems have a simpler structure and can often be manufactured at lower costs

# Kinematics of Multi-Axis Tip/Tilt Systems

Piezo tip/tilt mirror systems from PI are based on parallel kinematics with a single movable platform for all directions of motion. The systems achieve a higher linearity than can be attained by switching two single-axis systems in succession, as is the case with galvanoscanners, for example, and therefore, are very compact.

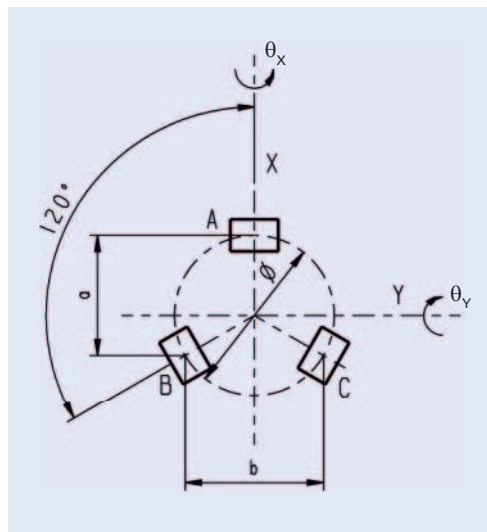
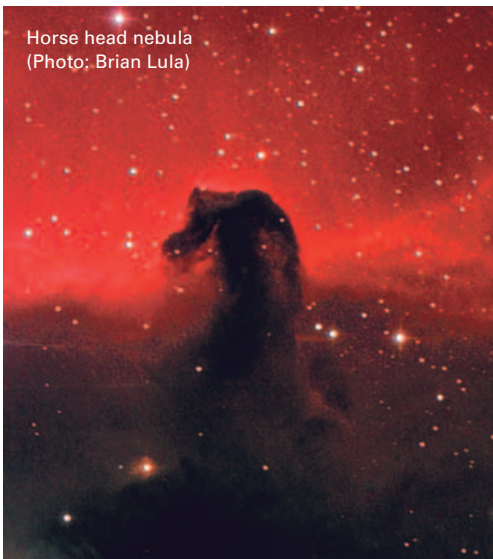

Arrangement of the actuators of a tripod piezo drive

The tilt angle and the travel in Z are calculated using the following formulas:

$$\theta_y = 2A - \frac{(B+C)}{2a}$$

$$\theta_x = \frac{(B-C)}{b}$$

$$Z = \frac{(A+B+C)}{3}$$

A, B, C is the linear displacement of the relevant actuators.

Piezo-actuated tip/tilt mirrors and platforms are suitable both for highly dynamic operation, such as tracking, scanning, image stabilization, elimination of drift and vibration, and for static positioning of optical systems and samples.

They allow for an optical beam deflection up to 100 mrad, extremely short response times from milliseconds to microseconds and resolutions down to nanoradians.

PI offers a large range from compact systems for laser beam steering up to large units used for astronomy.

### Tip/Tilt System with Tripod Piezo Drive

The platform is driven by three piezo actuators that are located in 120° angles to one another. By means of coordinate transformation, the motion can be split among the different actuators.

In addition to tilting, the platform may also be used linearly in Z direction, which is important, for example, for correcting optical path lengths (phase shifters).

### Tip/Tilt System with Differential Piezo Drive (Tetrapod)

The platform is driven by two pairs of piezo actuators located in 90° angles to one another. Four actuators are controlled differentially in pairs, depending on the tilt direction. The tilt axes  $\theta_x$  and  $\theta_y$  are arranged orthogonally so that a coordinate transformation is not necessary.

This concludes in an excellent stability in linear and angular positioning for a wide temperature range.

Just as the tripod, the differential version guarantees an optimum angular stability over a large temperature range. For position controlled versions, the differential evaluation of two sensors per axis provides an improved linearity and resolution.

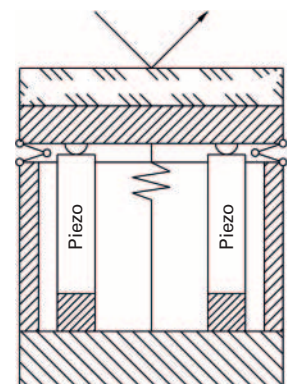

Principle of a tilt system with differential piezo drive

# Dynamics of a Piezo Tip/Tilt Mirror

The maximum operating frequency of a piezo tip/tilt system strongly depends on its mechanical resonant frequency. The properties of amplifier, controller and sensor are also important. To estimate the effective resonant frequency of the system – a combination of platform and mirror – it is necessary to calculate the moment of inertia of the mirror substrate first.

Moment of inertia of a rotationally symmetric mirror:

$$I_M = m \left[ \frac{2R^2 + H^2}{12} + \left( \frac{H}{2} + T \right)^2 \right]$$

Moment of inertia of a rectangular mirror:

$$I_M = m \left[ \frac{L^2 + H^2}{12} + \left( \frac{H}{2} + T \right)^2 \right]$$

with:

$m$  = mirror weight [g]

$I_M$  = moment of inertia of a mirror  
[g × mm<sup>2</sup>]

$L$  = mirror length orthogonally to tilt axis  
[mm]

$H$  = mirror thickness [mm]

$T$  = distance of pivot point to platform surface  
(see technical data of individual models)  
[mm]

$R$  = mirror radius [mm]

The resonant frequency of the system is calculated with resonant frequency of the platform (see technical data) and moment of inertia of the mirror substrate using the following formula:

$$f' = m \frac{f_0}{\sqrt{1 + I_M/I_0}}$$

Resonant frequency of a piezo tip/tilt system with mirror

with:

$f'$  = resonant frequency of platform with mirror [Hz]

$f_0$  = resonant frequency of platform without mirror [Hz]

$I_0$  = moment of inertia of platform (see technical data) [g × mm<sup>2</sup>]

$I_M$  = Moment of inertia of a mirror  
[g × mm<sup>2</sup>]

# Use in Vacuum

Piezo stages use technologies that are basically perfect for being used in a vacuum: Piezo actuators, capacitive position sensors and flexure guides. Furthermore, they need no lubricant or grease for operation.

The PICMA<sup>®</sup> piezo actuators in all PI nanopositioning systems are manufactured without polymers and, consequently, have particularly low gas emissions. They can be baked out at up to 150°C. The materials used for vacuum positioning stages are aluminum alloys, stainless steels or titanium. The surfaces are not coated but electropolished. Vacuum cable insulation is made of PTFE or FEP (Teflon), on request also of polyimide (Kapton) or PEEK. The use of plastics and adhesives is reduced as far as possible.



This piezo six-axis stage was developed for Physikalisch-Technische Bundesanstalt (PTB), the German national metrology institute, as object slide in an atomic force microscope (AFM); it is designed for use in UHV. The linear travel ranges are 12 μm × 12 μm × 10 μm; an active correction of the travel accuracy is possible by controlling the tilt axes. With a load of 300 g, it achieves a resonant frequency of over 2 kHz

### Vacuum Classification at PI

High vacuum (HV)	10 <sup>-3</sup> to 10 <sup>-6</sup> hPa
Ultrahigh vacuum (UHV)	10 <sup>-7</sup> to 10 <sup>-9</sup> hPa
1 hPa = 1 mbar	

For a number of positioning stage series, PI offers UHV versions as catalog products. Design and manufacture for ranges beyond these limits are offered on request. The vacuum feedthroughs are not included in the scope of delivery and may be ordered separately, if required.

# Special Ambient Conditions

### Magnetic Fields

PICMA<sup>®</sup> piezo actuators are excellently suited for being used in very strong magnetic fields. Piezo positioning systems can be manufactured without ferromagnetic materials.

Piezomotors can also be used in magnetic fields, because they do not generate magnetic fields nor are they affected by them.

### Low Temperatures

Piezo actuators show displacements to the cryogenic range. Special models of PICMA<sup>®</sup> actuators can be used down to -271°C but with a considerably reduced travel range. For designing a nanopositioning system, it is also important to select suitable materials and components.

# Sensor Technology for Nanopositioning Technology

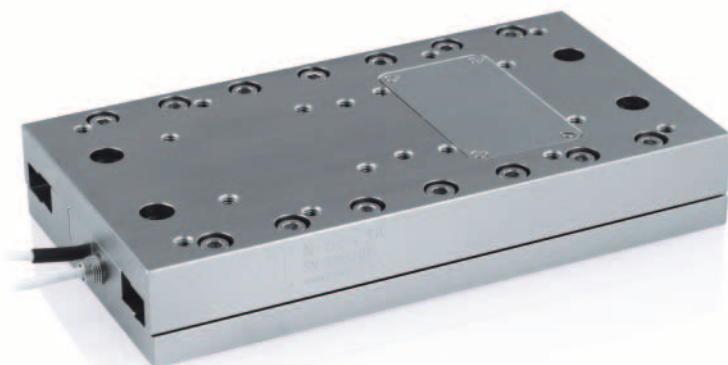

The PIOne linear encoder is used in PI's high-resolution nanopositioning system, such as N-664. This linear positioner is driven by NEXACT® piezo linear motors and, depending on the motion controller, can achieve a position resolution of less than one nanometer at 30 mm travel range

PI offers the widest range of high-dynamics and high-resolution nanopositioning systems worldwide. Their linearity and repeatability would not be possible without highest-resolution measuring devices.

Accuracies in the range of a few nanometers and below require a position measurement method that can also detect motion in this range. The most important specifications for selecting a suitable method are linearity, resolution (sensitivity), stability, bandwidth and, last but not least, the costs. Another important factor is the ability to directly record the motion of the platform. The contact with the movable parts also affects the measuring result; therefore, PI uses noncontact measurement methods as far as possible. Furthermore, the sensors need to be small and may not heat up.

PI nanopositioning systems use three different types of sensors: Capacitive sensors and linear encoders for direct metrology as well as strain gauges for indirect position measurement.

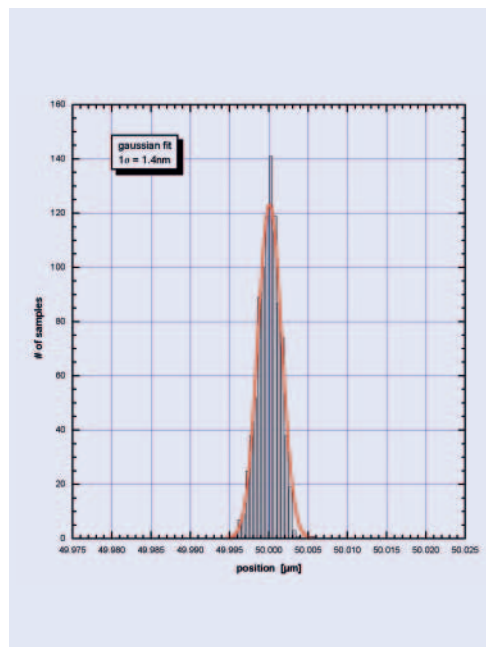

Measurements have confirmed the excellent repeatability of the piezo positioning system with capacitive sensors with 1.4 nm ( $1\sigma$  value) of standard deviation

## Maximum Accuracy through Direct Metrology

When directly measuring positions with noncontact sensors, each change in position of the moving platform is directly captured by the controller relatively to the base body. There are no drive or guiding elements, which would affect the measurement, between measured point and moving platform. This method allows a bandwidth in kilohertz range, resolution in sub-nanometer range and excellent stability.



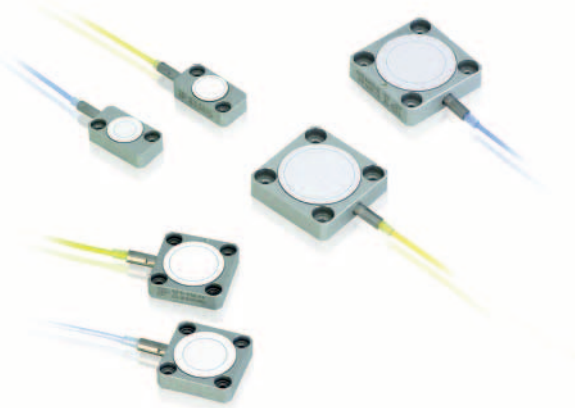

## Capacitive Sensors

Nanopositioning systems from PI are driven by translation piezo actuators and have travel ranges of a few hundred micrometers up to one millimeter. Capacitive sensors achieve a position resolution in the sub-nanometer range, high stability and bandwidth, as well as the best linearity and accuracy.

Capacitive sensors from PI determine the distance between two plate electrodes without contact. An active guard ring electrode generates a homogenous field in the measurement area. This and the very precise parallel adjustment of the two electrodes guarantees the best possible linearity of the sensor signals over the entire measuring range. These sensors are integrated in the nanopositioning system in such a way that no effects on size and mass (inertia) are to be expected. With a corresponding arrangement, they directly detect the motion of the platform (direct metrology).

PISeca single-plate capacitive sensors measure against all kinds of conductive surfaces and are easier to handle mechanically, for example during installation or cable routing. Their employment is also more versatile, e.g. for detecting motions perpendicular to the direction of measurement. The quality of the sensor signals, however, strongly depends on the parallelism and condition of the surface measured.

- Noncontact absolute measurement of distance, motion and vibration
- Measuring ranges from a few 10  $\mu\text{m}$  to 2 mm feasible
- Only minimum heating, no scattered light
- Direct metrology: Direct position measurement of moving objects

- Vacuum compatible down to  $10^{-9}$  hPa
- Maintenance-free, no wear
- High bandwidth up to 10 kHz
- High temperature and long-term stability (<0.1 nm/3 h)
- Invar versions for highest temperature stability ( $5 \times 10^{-6}/\text{K}$ )
- Compact one and two-electrode sensors, custom designs
- Processing electronics in various configuration levels, from analog OEM versions to a modular digital controller system that can be expanded at any time

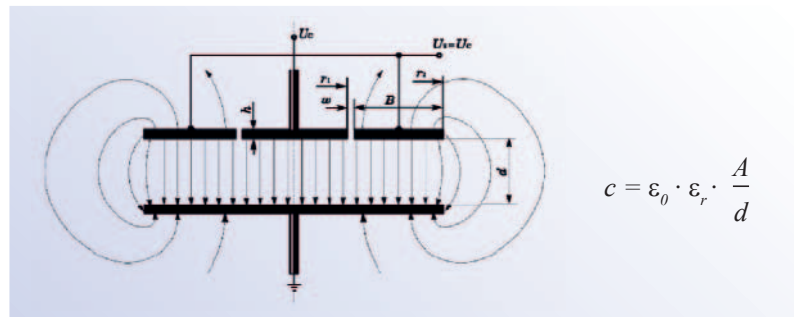

$$C = \epsilon_0 \cdot \epsilon_r \cdot \frac{A}{d}$$

Operating principle of a capacitive sensor. The capacitance  $C$  is proportional to the active sensor area  $A$ ,  $d$  is the measuring range (distance from sensor to target surface),  $\epsilon_0$  is constant,  $\epsilon_r$  is the dielectric constant of the material between the plates, generally air. The measured quantity is the change in capacitance of the electric field. An active guard ring electrode generates a homogenous field in the measurement area

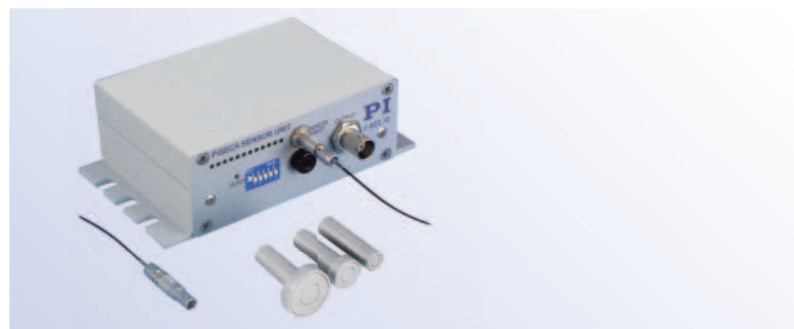

PISeca single-electrode capacitive sensors measure against all kinds of conductive surfaces and are easier to handle mechanically, for example during installation or cable routing. Their employment is also more versatile, e.g. for detecting motions perpendicular to the direction of measurement. The E-852 stand-alone processing electronics for PISeca only shows minimum noise and integrates a linearization system. All systems are calibrated at PI and optimized for the intended bandwidth and the measuring range

**PIOne Linear Encoders:  
Small with Picometer Resolution**

The capacitive measuring systems reach their limits with larger travel ranges: Either sensor areas become larger or resolution and linearity deteriorate. Nanopositioning system with piezomotors, which have travel ranges of several 10 millimeters, use linear encoders as position sensors. These are incremental measuring systems that consist of a scale and sensor head. The high-resolution linear sensor PIONe ensures a position resolution of far less than a nanometer with adequate processing of the measurement.

The sensor head of the PIONe contains a Mach-Zehnder interferometer, which is moved along a linear scale. Sine and cosine signals are generated from the signals of the reflections at the grid. Additional interpolation accounts for the demonstrably small resolution of the system. The sensor head also generates a direction-sensing reference. The sensor head here measures  $23 \times 12 \times 9.5 \text{ mm}^3$ . PIONe uses a patented technology.

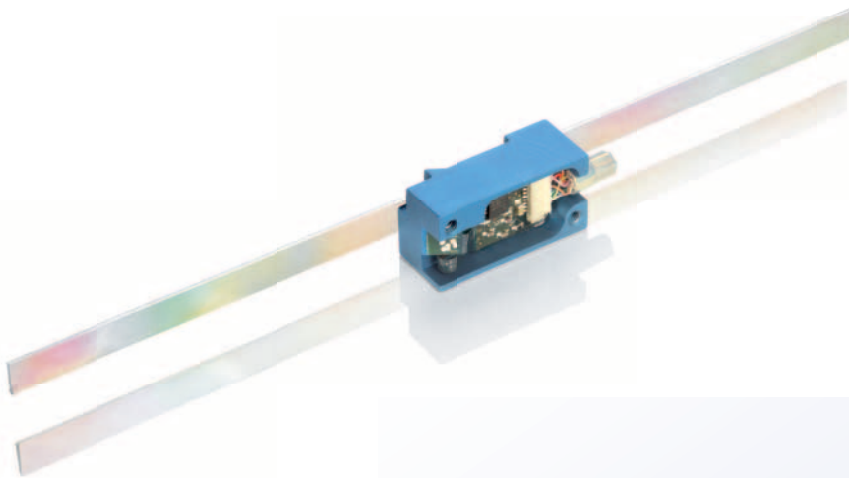

- Resolution to 20 picometer RMS; 0.12 nanometer peak-to-peak
- Velocities up to 0.5 m/s at maximum resolution
- Compact dimensions  $23 \text{ mm} \times 12 \text{ mm} \times 9.5 \text{ mm}$
- Sine, cosine or quadrature output signals
- Low power consumption and low heat dissipation
- Bakeout temperature up to  $80^\circ\text{C}$

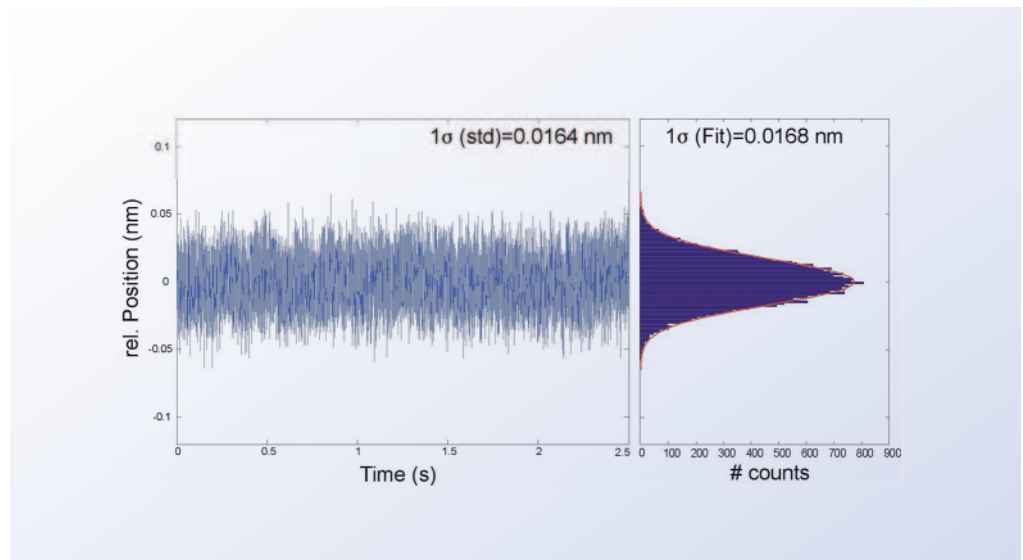

Noise measurement of a positioning system with the PIONe at 1 MHz bandwidth and 18-bit resolution of the sensor input: 16 picometer RMS and 100 picometer peak-to-peak

## Indirect Position Measurement with Strain Gauge Sensors

Strain gauge sensors consist of a thin metal (SGS) or semiconductor foil (piezo-resistant, PRS), which is attached to the piezoceramics or, for improved precision, to the guiding system of a flexure stage. This type of position measurement is done with contact and indirectly, since the position of the moving

platform is derived from a measurement on the lever, guide or piezo stack. Strain gauge sensors derive the position information from their expansion. Full-bridge circuits with several strain gauge sensors per axis improve thermal stability.

Sensor type	Sensitivity/Resolution*	Linearity*	Stability/Repeatability	Bandwidth*	Measurement method	Measurement range
Capacitive	excellent	excellent	excellent	excellent	direct / noncontact	<2 mm
Strain gauge sensors made of metal foil (SGS)	very good	very good	good	very good	indirect / with contact	<2 mm
Piezoresistive strain gauge sensors (PRS)	excellent	good	average	very good	indirect / with contact	<1 mm
Linear encoders	excellent	very good	excellent	very good	direct / noncontact	up to >100 mm

\* The classifications refer to the characteristics of the nanopositioning system. The information on resolution, linearity and repeatability in the respective data sheet reflects the specifications of the overall system, including controller, mechanical system and sensor. They are tested using external measuring instruments (Zygo interferometer)

## Direct Parallel Metrology: Multi-Axis Measurements using a Fixed Reference

A multi-axis stage design with parallel kinematics allows you to use direct parallel metrology, measuring all degrees of freedom of the moving platform in relation to a fixed reference. Unintended crosstalk of the motion into a different axis, e.g. as a result of an external force, can thus be detected and actively corrected in real time. This so-called active guiding can keep the deviation from the trajectory down to a few nanometers, even in dynamic operation.

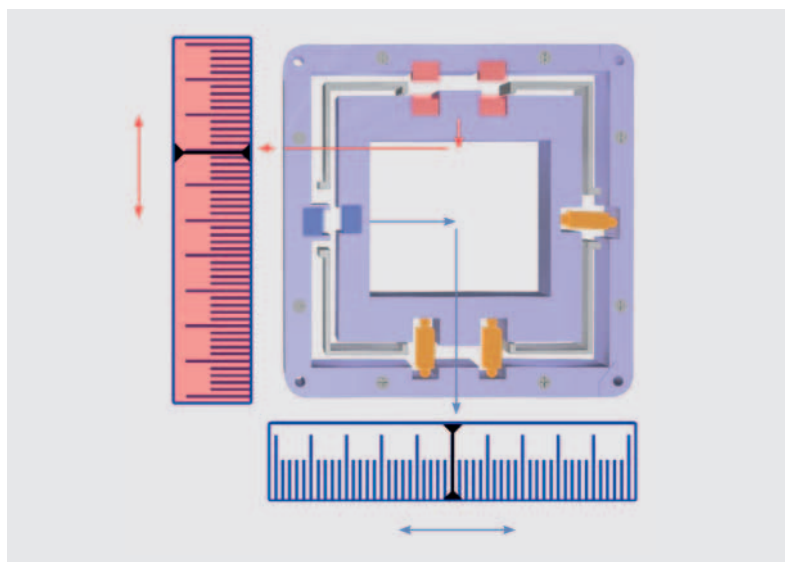

Parallel-kinematic nanopositioning system with capacitive sensors, parallel-metrology arrangement and reduced inertia. The arrows show the signal flow from the sensor to the closed-loop control. Red: X axis, blue: Y axis

# Precision Motion Control

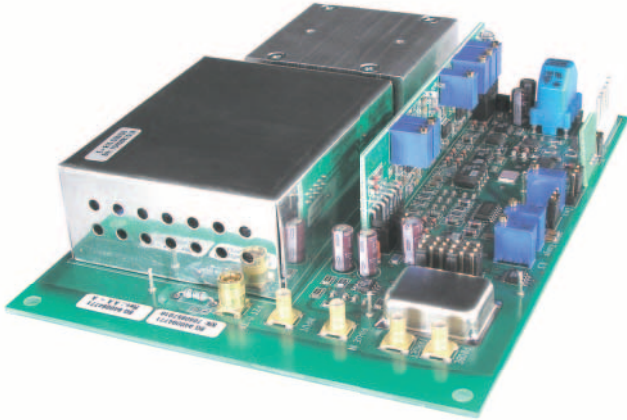

OEM piezo controller card. The piezo control voltages are generated on-board, operation only requires a stabilized voltage between 12 and 24 V

### Closed-loop PI piezo controllers feature:

- High linearity
- Positioning with sub-nanometer accuracy
- Excellent long-term stability
- Noise approx. 1 mV (RMS value)
- Low power consumption
- Notch filter for higher bandwidth
- Output voltages adapted to various piezo actuators and piezo drives
- Analog interfaces for fast direct commanding in real time
- Short-circuit strength

### Flexible Controllers to Match the Mechanics

PI offers the world's largest portfolio of precision motion technologies for positioning in the accuracy range from one micrometer down to below one nanometer. Fast settling or extremely smooth low speed motion, high positional stability, high resolution and high dynamics – the requirements placed on piezo mechanisms vary greatly and need drivers and controllers with a high degree of flexibility. PI provides a broad spectrum of piezo electronics from versatile general purpose controllers to highly specialized devices. Units come in different levels of integration from customized OEM boards and a plug & play bench-top devices to modular controllers to scalable to almost any number of axes.

Piezo mechanisms directly respond to the smallest change in the drive voltage with a change in displacement. Response times of a few microseconds are possible, depending on the mechanical design and the performance of the piezo controller.

In static operation, i.e. when a certain position is held, the stability of the power supply is also decisive because piezo actuators react even to the minutest change in voltage with a motion. Therefore, noise or drifting must be avoided as much as possible.

This high-performance piezo controller delivers peak power of up to 6 kW. A digital interface module offers extended functionalities, such as data recorder and function generator



## Optimized Control Design Improves System Properties

The performance of a piezo mechanism not only depends on the mechanical design but also largely on the capabilities of its controller. PI's low-noise, drift-free piezo amplifiers ensure optimum stability and resolution. High bandwidth allows for rapid response times and high scanning frequencies.

Closed-loop position control compares the target position with the information provided by the position feedback sensor (actual value) and automatically compensates for nonlinearity, hysteresis and drift.

The servo-control part of most analog piezo controllers manufactured by PI is identical: A proportional integral control loop specifically optimized for piezo operation. One or more adjustable notch filters considerably improve usable bandwidth and dynamics because resonances are suppressed before they can affect the system stability. In digital controllers, optimized control algorithms further minimize settling times and increase bandwidth and stability. High-end closed-loop piezo positioning systems can achieve a repeatability down to the sub-nanometer range and bandwidths to 10 kHz.

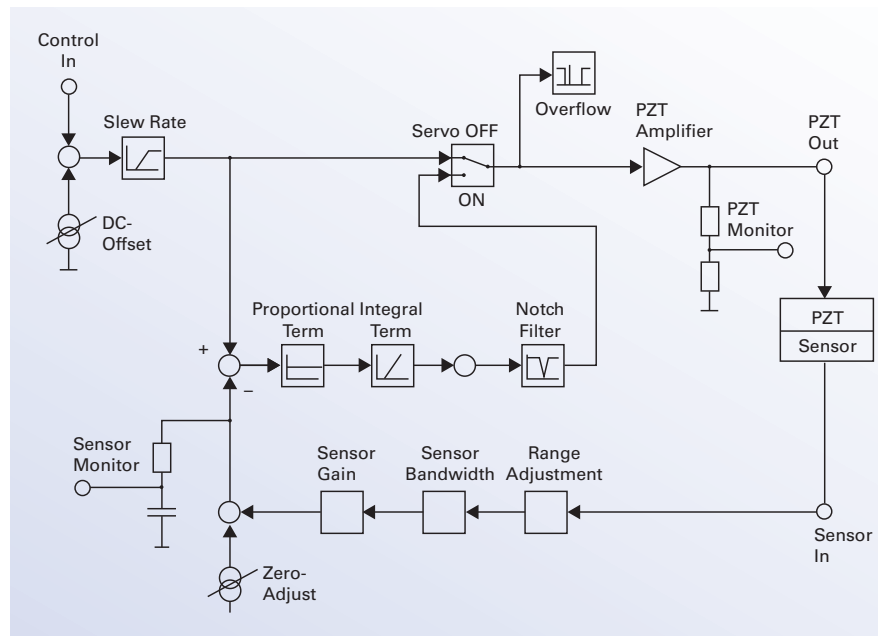

Block diagram of a typical closed-loop piezo controller

## Resolution in Closed-Loop and Open-Loop Control

Closed-loop piezo systems guarantee higher linearity and repeatability than open-loop systems. The position resolution of piezo actuators and flexure-based piezo mechanisms is not limited by friction but influenced by electrical noise at the sub-nanometer level.

Because of the additional sensor and the servo circuit, the noise is slightly higher in closed-loop operation compared to open-loop control, where only the piezo amplifier contributes to electrical noise. If high-quality components are used, sub-nanometer positional noise levels are possible in closed-loop operation. Capacitive position sensors achieve the best resolution, linearity and stability.

### Advantages and Disadvantages of Position Control

Most precision positioning applications greatly benefit from closed-loop control. When maximum bandwidth is crucial, open-loop may be worth a consideration: A closed-loop controller always operates in the linear range of voltages and currents. Since the peak current is limited in time and is therefore nonlinear, it cannot be used for a stable selection of control parameters. As a result, position control limits the bandwidth and does not allow for pulse-mode operation. In switching applications, it may not be possible to attain the necessary positional stability and linearity with position control. Open-loop operation may be a better choice here with linearization obtained by means of charge-controlled amplifiers or by numerical correction methods.

In closed-loop operation, the maximum safe operating frequency is also limited by the phase and amplitude response of the system. Rule of thumb: The higher the resonant frequency of the mechanical system, the higher the control bandwidth can be set. The sensor bandwidth and performance of the servo (digital or analog, filter and controller type, bandwidth) also limit the operating bandwidth of the positioning system.

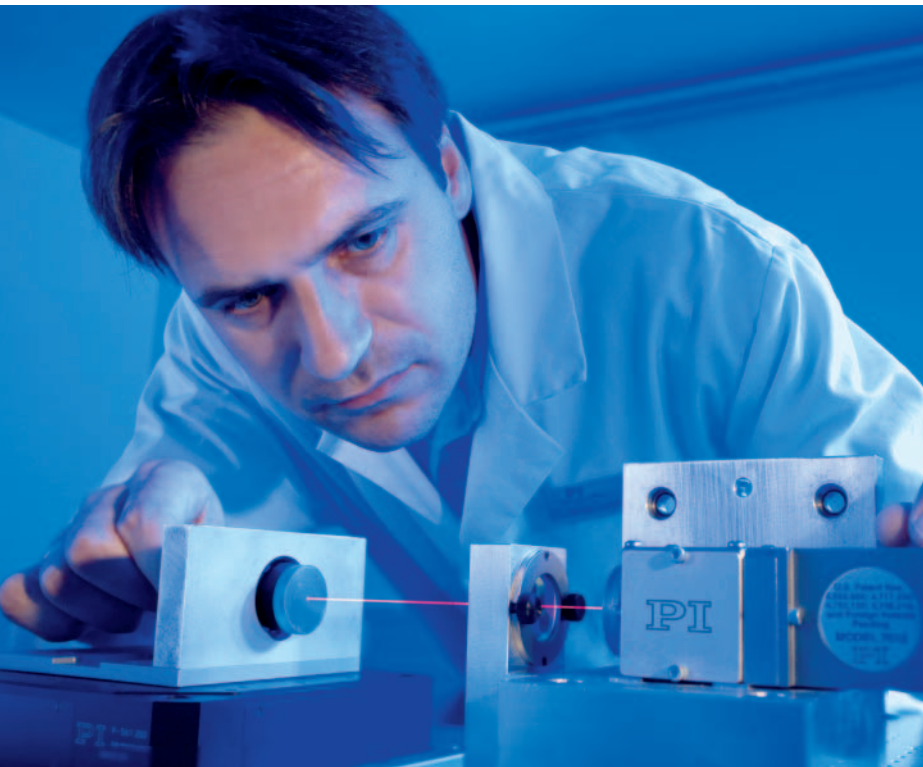

### Standardized Measurements Logs: The Good Feeling When Your Expectations Are Met

Nanopositioning systems are an essential but costly component in applications. PI therefore individually tests and optimizes the static and dynamic parameters of every system. The measurement log is delivered with the system. The customer can thus retrace the performance of the system at delivery and which system components belong together at any time.

PI continually invests in improving the testing methods and testing equipment in order to be able to supply systems of even higher quality. Closed-loop nanopositioning systems are tested exclusively with high-quality calibrated interferometers. The test laboratories are insulated against seismic, electromagnetic and thermal effects, temperature stability is better than 0.25°C in 24 hours. PI thus sets the standard in the testing and specification of nanopositioning products.

### Controller Tuning

To optimize the system performance, information about the application is required, such as the desired operating frequency, step-and-settle, the size and weight of the payload, or the spring constant of a preload in relation to which the piezo actuator is operated.

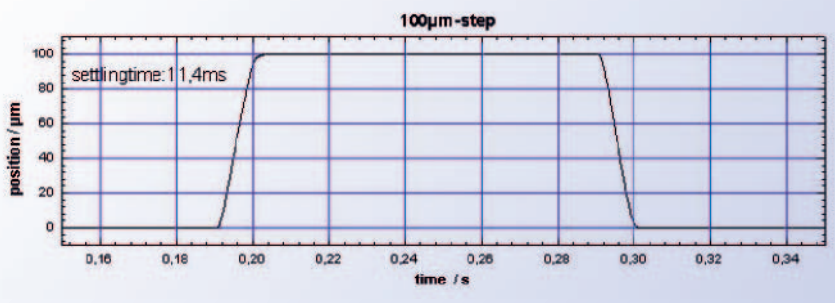

Highly dynamic, closed-loop nanopositioning system: A piezo scanner achieves the full travel range of 100 µm in only a few milliseconds

# Digital Controllers Provide Precision, Dynamics and Ease of Operation

Digital piezo controllers have several advantages over analog servo circuits: Linearity and settling behavior can be specifically influenced by digital algorithms allowing much greater flexibility than analog circuits. The result is higher precision and better dynamic performance.

## Linearization of the Electronics

With digital servo controllers it is possible to upload calibration data quickly and remotely. PI piezo stages can store optimized parameters in an ID chip. With this combination, controllers and mechanics can be swapped without performance losses, because the controller recognizes the mechanics and reads specific linearization and calibration data when it is powered up.

## Controllers and Servo Techniques

The task of a servo loop is to correct deviations between the actual position and the target position. Commonly, this is done with PI (proportional-integral) controllers. Depending on the application, however, advanced control techniques in combination with linearization algorithms can yield better results. Digital filters avoid undesired mechanical excitation, suppress noise and, with that, increase the resolution and system bandwidth.

## Linearization of the Mechanical System

The linearity of the entire system is one criterion for its positioning accuracy. Piezo actuators typically show a nonlinearity of 10 to 15%, which has to be compensated by the control loop. Digital controllers use higher-order polynomials to reduce the motion nonlinearity to values below 0.001%, which, for a typical travel range of 100  $\mu\text{m}$ , corresponds to an accuracy of one nanometer and better.

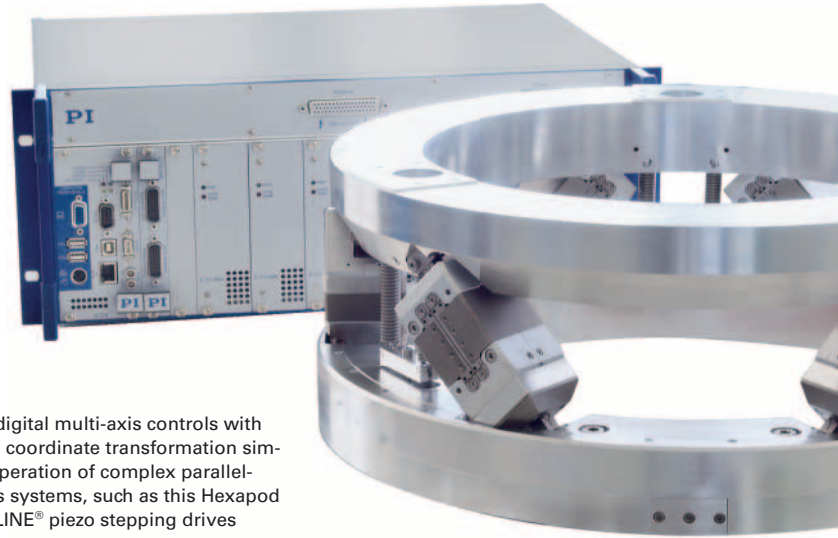

Modular, digital multi-axis controls with integrated coordinate transformation simplify the operation of complex parallel-kinematics systems, such as this Hexapod with NEXLINE<sup>®</sup> piezo stepping drives

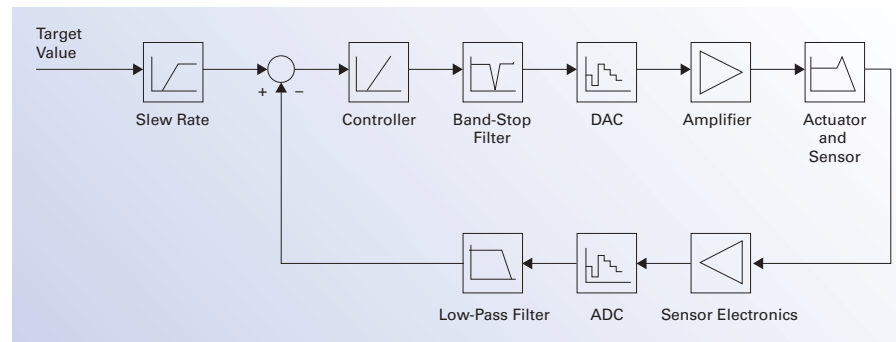

Block diagram of a digital piezo servo controller

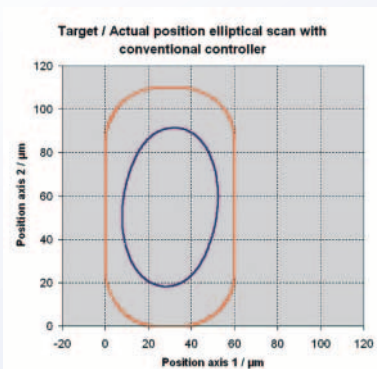

Elliptical scan (for laser micro bore applications) with an XY piezo scanning stage and conventional PID controller. The outer curve shows the desired position, the inner curve shows the actual motion

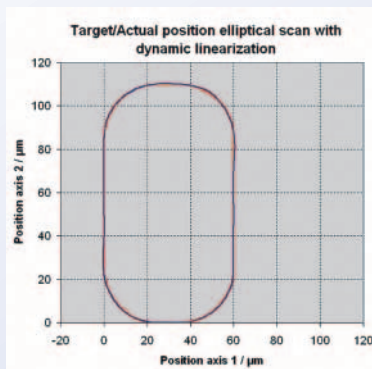

The same scan as before but with a DDL controller. The tracking error is reduced to a few nanometers, target and actual position cannot be distinguished in the graph

### Dynamic-Linearization: Following a Moving Target

Dynamic digital linearization (DDL) reduces the dynamic tracking errors of periodic trajectories. This is relevant for scanning applications, where a specific position must be identified on the fly and later be approached with high precision, or for applications where a trajectory must be followed at very high speed with minimum deviation for processing steps.

### Additional Functions of Digital Controllers

Computing power and memory size which go hand in hand with digital controllers allow useful additional functions to be implemented.

- Software access to all motion parameters and the graphic display of the results
- Coordinate transformation for parallel kinematics for simple control in Cartesian coordinates
- Macro memory to store and retrieve motions which can be triggered externally
- Function generator and waveform memory for the retrieval of predefined trajectories and the generation of customized waveforms
- Data recorders record sensor and control data for subsequent processing
- The ID chip permits the flexible exchange of controllers and nanopositioners without the need to retune the operational parameters

Not all controllers provide the above-listed functions. The individual ranges of functions are listed in the relevant datasheets.

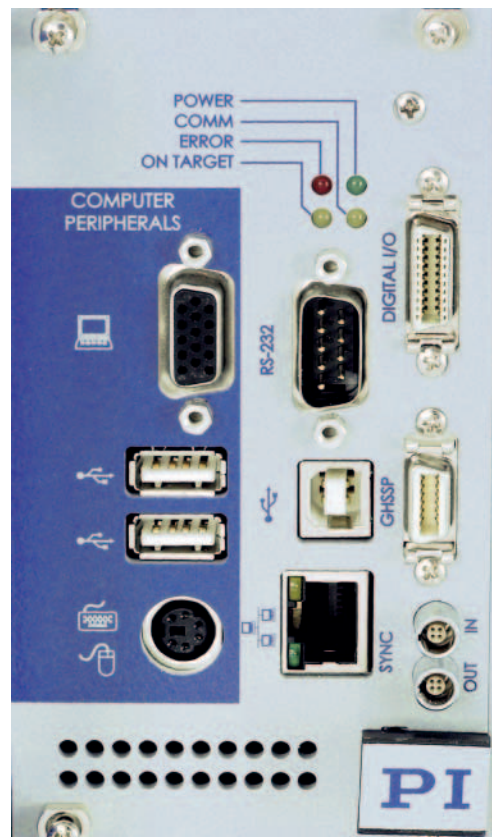
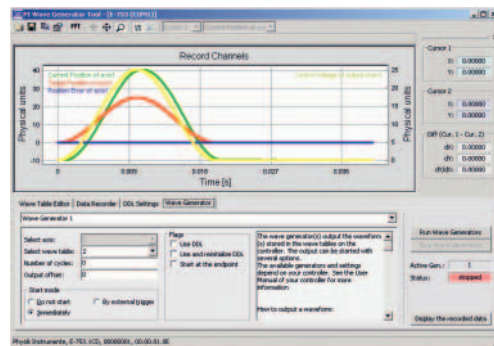

The standard interfaces for digital nanopositioning controllers are RS-232, USB and TCP/IP. Additionally, PI offers digital I/O lines, options for analog interfaces and real-time PIO

Complex motion profiles can be generated, saved and implemented with the function generator



# Motion Control Software from PI

Effective and Comfortable Solutions

## Parallel Kinematics

UP TO 6 DEGREES OF FREEDOM

## Nanopositioning

SUB-NANOMETER RESOLUTION



## Drive Technology

DC, STEPPER, PIEZO, MAGNETIC

## Micropositioning

LONG TRAVEL RANGES

All digital controllers made by PI are accompanied by a comprehensive software package. PI supports users as well as programmers with detailed online help and manuals which ease initiation of the inexperienced but still answer the detailed questions of the professional. Updated software and drivers are always available to PI customers free of charge via the Internet.

PI software covers all aspects of the application from the easy start-up to convenient system operation via a graphical interface and fast and comprehensive integration in customer written application programs.

### Universal Command Set Simplifies Commissioning and Programming

PI developed the PI General Command Set (GCS) that is used to control all nano- and micro-positioning systems regardless of the drives and motion controllers used. GCS with its many preprogrammed functions accelerates the orientation phase and the application development process significantly while reducing the chance of errors, because the commands for all supported devices are identical in syntax and function.

#### Supported Operating Systems

- Windows XP (SP3)
- Windows VISTA
- Windows 7 32/64 bit
- Linux 32/64 bit
- Windows 8 32/64 bit

### PIMikroMove Software Ensures Rapid Start-Up

PIMikroMove is PI's convenient graphical user interface for any type of digital controller and positioning system, regardless of whether piezoelectric, linear motors, or classical electrical motor drives are used and independent of the configuration and number of axes.

All connected controllers and axes are displayed and controlled consistently with the same graphical interface. For a multi-axis application, various controllers can be used and commands can still be issued via PIMikroMove in the same window. Two or more independent axes can be controlled by the position pad using a mouse or joystick; Hexapod six-axis positioning systems are also displayed graphically.

Macro programs simplify repetitive tasks for example in automated processes. The macros are created as GCS command sets that can be executed directly on the controller, e.g. as a start-up macro that allows stand-alone operation; they can also be processed by the host PC.

Scan and align algorithms can record analog values, e.g. the output of a power meter as a

function of position for later evaluation with external software. They can also automatically find the global maximum of, for example, the coupling efficiency of optical devices.

Depending on the specific controller, PIMikroMove supports a number of additional functions. A data recorder can record system parameters and other variables during motion for later analysis.

### Optimizing System Behavior

When the mechanical properties of a positioning system are changed, e.g. by applying a different load, motion control parameters often need to be adapted. PI software provides tools for optimization of the system response and stability. Different parameter sets can be saved for later recall, also accessible from custom application programs.

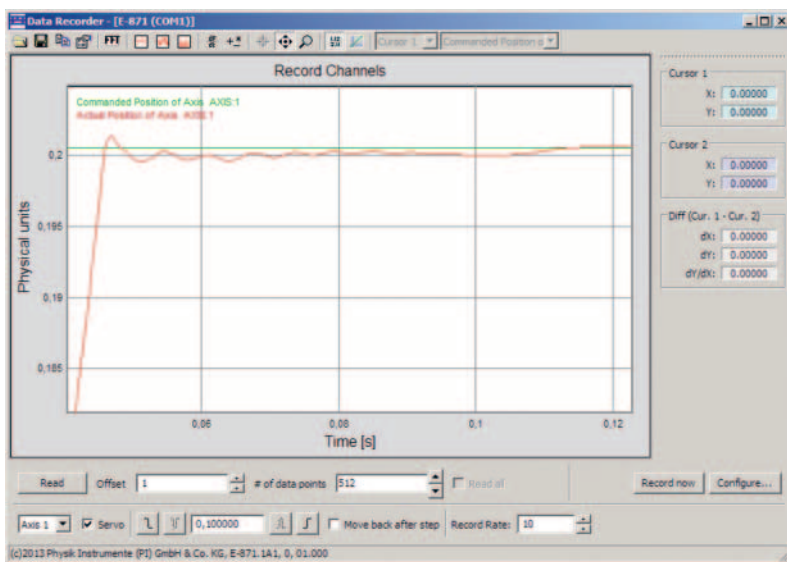

The flexibly configurable data recorder records data, such as position, sensor signal or output voltage in relation to time

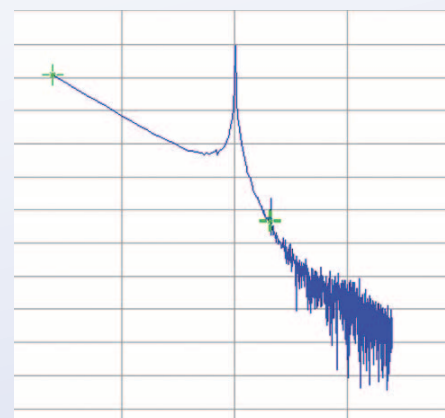

Convenient operation and performance optimization with PI software: The parameter setting tool shows the frequency response of a nanopositioning stage in Bode plot

## Motion Control Software from PI

### Fast Integration of PI Controllers in Third-Party Programming Languages and Software Environments

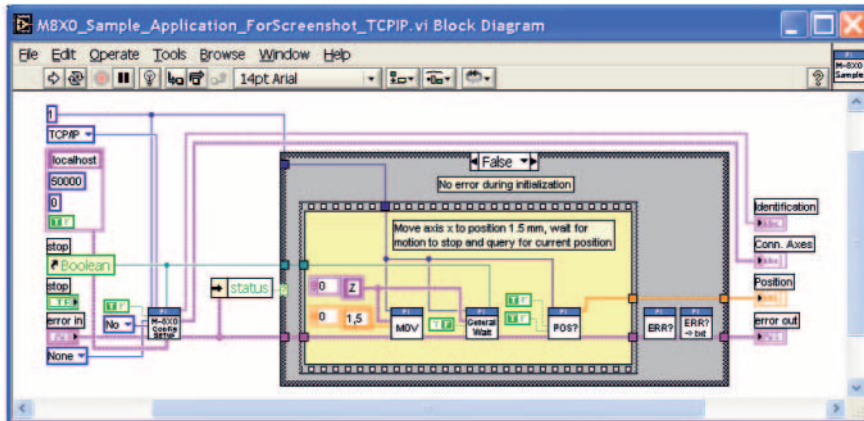

Currently, many applications are produced in LabVIEW, e.g. in measuring and control technology and automation engineering. PI provides complete LabVIEW drivers sets to facilitate programming. A controller-specific Configuration\_Setup VI is integrated at the start of the LabVIEW application and includes all system information and initiation steps required for start-up. The application itself is implemented with controller-independent VIs.

In case of a controller change or upgrade, it is usually only necessary to exchange the Configuration\_Setup VI, whereas the application-specific code remains identical due to the consistent GCS command set structure.

The driver set includes many specific programming examples, e.g. comprehensive scan and align routines that can be used as template for customer-specific programs. Moreover, the open source code of many VIs allows for rapid adaptation to the user needs.

#### Flexible Integration in Text-Based Programming Languages

The integration of PI positioning systems in text-based programming languages under Microsoft Windows or Linux is simplified by program libraries and exemplary codes.

These libraries support all common programming languages and all PI positioning systems, allowing the PI GCS command set functions to be integrated seamlessly in external programs.

#### Third-Party Software Packages

Drivers for the PI GCS commands have now been integrated in many third-party software packages. This allows for the seamless integration of PI positioning systems in software suites such as MetaMorph,  $\mu$ Manager, MATLAB and ScanImage. Moreover, EPICS and TANGO drivers are available for integration into experiments of large-scale research facilities. The drivers for  $\mu$ Manager, MATLAB and a large part of the EPICS drivers are being developed and serviced in-house by PI.

**MATLAB<sup>®</sup>**  
**Enabled**

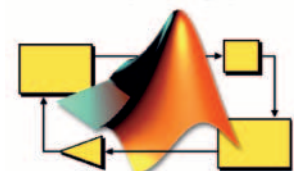

MathWorks Partner



#### Supported Languages and Software Environments

- C, C++, Python, Visual C++, Visual Basic, Delphi
- LabVIEW, MATLAB,  $\mu$ Manager, EPICS, TANGO, MetaMorph
- and all programming environments that support the loading of DLLs

# Service

The scope of delivery of a PI system consisting of controller and stage includes everything required for its operation.

- External power supplies
- All power, communication and system cables
- The comprehensive user manual in printed form
- Software CD with set-up function

When developing the instruments, top priority is given to the use of state-of-the-art components. This ensures a **long availability** and replaceability of the systems even beyond the product lifecycle. All positioning systems from PI's standard range fulfill the CE and RoHS provisions.

**Customized product developments and adaptations** are an important part of our technical progress.

We offer you:

- The complete range of our product spectrum from electronic components and complete devices as an OEM circuit board through to the modular encased system
- Production of small batches and large series
- Product development according to special product standards (national or market-specific standards such as the German Medical Device Act, for example) and the corresponding certification
- Adaptation of the systems to special environmental conditions (vacuum, space, clean room)
- Copy-exactly agreements

The current versions of firmware, software and user manuals are available on the internet free of charge. Firmware updates can easily be carried out via the standard interfaces of the controller. PI offers comprehensive software support. PI software is included in the scope of delivery for digital equipment and is used to start up the system and also to analyze and optimize the system's behavior. DLLs, LabVIEW drivers or the support of MATLAB make it easier to program the system.



# Glossary

## Amplifier classification

PI uses the following amplifier classifications: Charge-controlled, switched (class D), linear.

## Amplifier resolution

Only for digitally controlled amplifiers: Measurement of the smallest digital output value (LSB) in mV.

## Average current

For multi-axis controllers, it is specified per channel. Measured value. It is available reliably over a longer period.

## Bandwidth

Measured value. The frequency in kHz, with which the amplitude decreased by -3 dB, is specified. Large signal values: With maximum output voltage. Small signal values: With output voltage of  $10V_{pp}$ . The values are displayed in the amplifier operating diagram.

## Capacitive base load (internal)

For switching amplifiers. Stabilizes the output voltage even without connected capacitive load (piezo actuator). The possible output power of a piezo controller/driver depends on internal and external capacitive loads.

## Control input voltage range

Also input voltage; for piezo controller/driver. Recommended range from -2 to 12 V. The usual gain value of 10 V leads to an output voltage of -20 to 120 V. Most PI controllers allow for an input voltage range of -3 to 13 V.

## Current consumption

Current consumption of the system on supply end. It is specified for controller without load. Alternatively, power consumption.

## Current limitation

Short-circuit protection.

## Drive type

Defines the types of drive supported by the controller/driver, such as DC motors, piezo stepping drives, piezo actuators.

## Dynamic resolution

For capacitive sensors. Measured in the nominal measuring range, bandwidth see data table. See static resolution.

## Encoder input

Maximum bandwidth (-3 dB) of the input signals for the encoder input.

## Input level

Permissible input level for digital interfaces.

## Limit switches

Function: Optical, magnetic.

## Linearity error

Value gained with external, traceable measuring device. Defines the maximum deviation from an ideal straight motion. The value is given as a percentage of the entire measuring range. The linearity error does not influence the resolution or repeatability of a measurement.

Measurement of the linearity error: The target and measured actual values of the positions are plotted against each other, a straight line is drawn through the first and last data point, and the maximum absolute deviation from this straight line is determined. A linearity error of 0.1% corresponds to an area of  $\pm 0.1\%$  around the ideal straight line. Example: A linearity error of 0.1% over a measuring range of 100  $\mu\text{m}$  produces a possible maximum error of 0.1  $\mu\text{m}$ .

## Linearization

Integrated method, e.g. ILS, polynomials to the  $n^{\text{th}}$  degree, sensor linearization.

## Measurement range extension factor

For capacitive sensors, used by PI.

## Noise

For capacitive sensors. In extended measurement ranges, noise is considerably higher than in the nominal measurement range.

## Operating limits

Values measured at an ambient temperature of 20°C. A sine is used as control signal in open-loop operation. The amplifier works linearly within the operating limits, in particular without thermal limitation.

## Operating temperature range

In any case, the device can be operated safely in the maximum permissible temperature range. To avoid internal overheating, however, full load is no longer available above a certain temperature (maximum operating temperature under full load).

## Operating voltage

Allowed control input voltage range (also input frequency) for the supply of the device.

## Output voltage

The output voltage of piezo controllers shows variations of only a few millivolt and is particularly stable in the long term.

## Overtemperature protection

Switch-off temperature for voltage output. No automatic restart.

## Peak current

Only available for very short times, typically under a few milliseconds. It is used to estimate the possible dynamics with a certain capacitive load. Note: In this case, the piezo controller/driver does not necessarily work linearly.

## Power consumption

Maximum power consumption under full load.

## Profile Generator

Linear interpolation, point-to-point, trapezoid, double bends. For several axes: Electronic gearing.

## Reference point switch

Function: Optical, magnetic.

## Resolution

Position resolution relates to the smallest change in displacement that can still be detected by the measuring devices. The uncontrolled resolution in piezo nanopositioning systems and piezo actuators is basically unlimited because it is not limited by static or sliding friction. Instead, the equivalent to electronic noise is specified.

## Rise time

Time constant of the controller/driver. Time required for increasing the voltage range from 10% to 90%.

## Ripple, noise, 0 to 100 kHz

Ripple of voltage in  $\text{mV}_{pp}$  with unique frequency. Noise over the entire frequency range.

## Sensor bandwidth

Measured value. The frequency, with which the amplitude decreased by -3 dB, is specified.

## Sensor resolution

The sensor can be the critical element in position resolution, for this reason the sensor resolution can be specified separately if necessary.

## Static resolution

For capacitive sensors. Measured with a bandwidth of 10 Hz, nominal measuring range.

## Suggested capacitive load

For switching amplifiers. The possible output power of a piezo controller/driver depends on internal and external capacitive loads.



# Piezo Drives

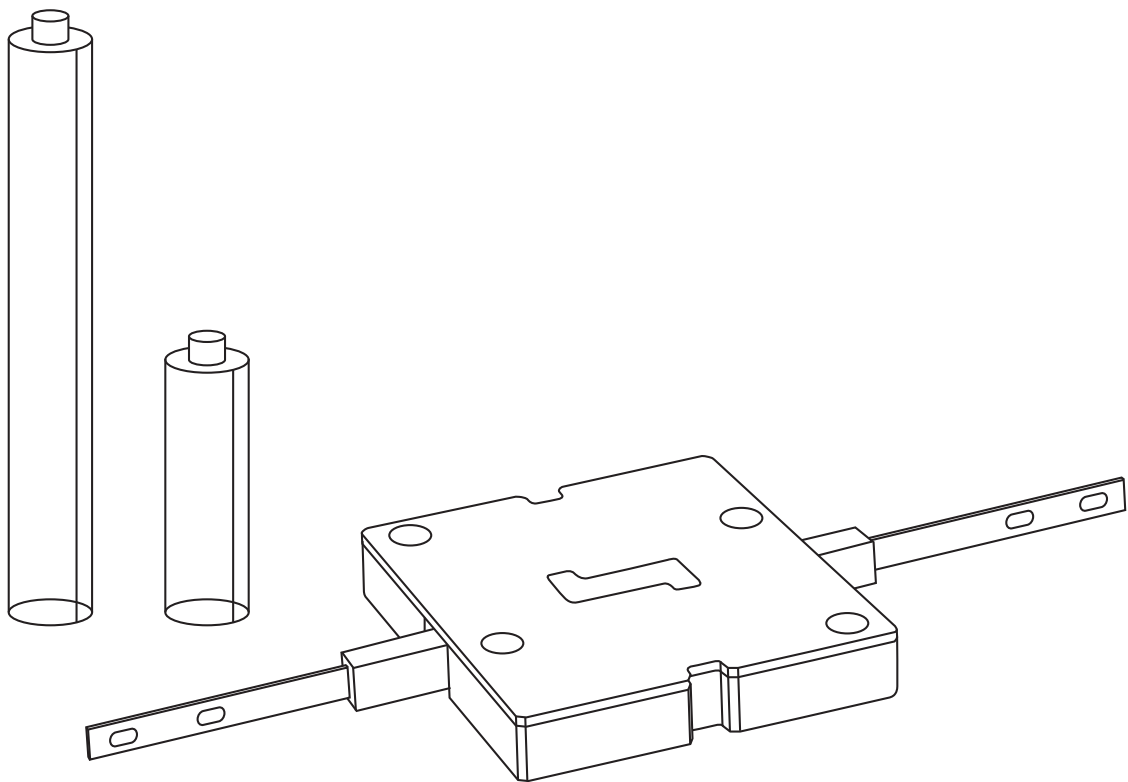

---

**Products**

**Pages 102–125**

---

**Fundamentals of Piezo Technology**

**Pages 126–157**

---

# Piezomotors

## Integration Examples of Piezo Linear Motors



PILine® motors act on an annular runner, producing a rapid rotary motion, e.g. for this Leica TS30 total station for automated angle and distance measurement at high accuracy and reliability (Photo: Leica Geosystems)





## Piezo Linear Motors

First Integration Levels for OEM Applications

Page 102

## Technologies of Piezomotors

Page 104

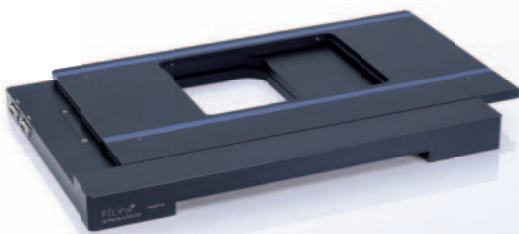

Integration of PLine® ultrasonic motors allows the design of XY stages with particularly low height e.g. for microscopy



Compact special design of a linear positioning stage with NEXACT® piezo stepping drive and precision linear guides. The dimensions are only 33 mm x 24 mm x 20 mm

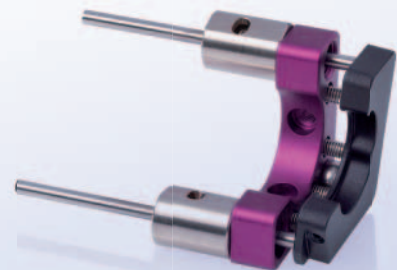

PIShift drives adjust the tilting angles in a cardanic mirror holder

# Piezo Linear Motors

## First Integration Levels for OEM Applications

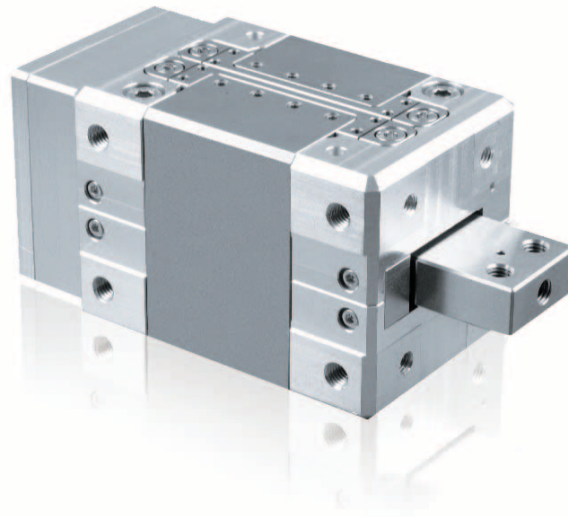

N-216

## Highlights

- Wide range of different piezomotor technologies: Forces from 10 to 800 N
- Self-locking at maximum force, thus no heat generation at rest
- The travel range is scalable and limited only by the runner length
- Easy integration, replacement for motor-spindle drives
- Nonmagnetic designs available on request
- Vacuum-compatible up to  $10^{-6}$  mbar; UHV on request

## Applications

Applications range from sample handling in biotechnology to positioning of optical components in imaging processes. PI uses piezomotors as space-saving and high-resolution drive element in single- and multi-axis positioning systems. Integration ranges all the way to complex 6D Hexapods, which can also be used under extreme ambient conditions such as UHV or magnetic fields.

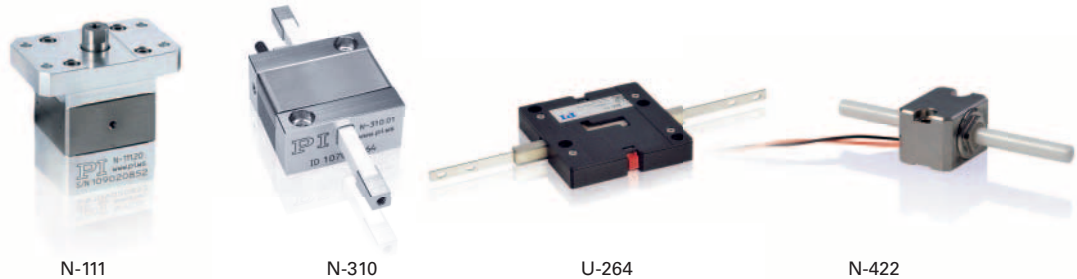

N-216 N-111	N-310	U-264	N-422
----------------	-------	-------	-------

	Versions with high-resolution integrated linear encoder available	Sub-nm resolution, velocity controllable to a few nm/s	Cost-efficient and fast	Easy-to-control 1-actuator principle with sub-nm resolution
Drive type	NEXLINE® piezo stepping drive	NEXACT® piezo stepping drive	PILine® ultrasonic piezomotor	PIShift Piezo inertia drive
Dimensions in mm	50 × 50 × 80 (N-216) 28 × 40 × 40 (N-111)	25 × 25 × 12	57 × 63 × 10.2	21.5 × 18 × 13
Velocity	a few nm/s to 1 mm/s maximum	a few nm/s to 20 mm/s	a few nm/s to 500 mm/s	a few nm/s to 20 mm/s
Push/pull force in N	up to 600	up to 20	up to 40	up to 10
De-energized holding force in N	up to 800 / self-locking	up to 20 / self-locking	up to 40 / self-locking	up to 10 / self-locking
Smallest step size without sensor in mm	0.03	0.03	50	300 with E-870 driver
Operating voltage	-250 / 250 V bipolar	up to 45 V	up to a voltage range of 200 V	up to a voltage range of 48 V
Travel range in mm	20	up to 125	up to 150	up to 40
Mass in g	1200 (N-216) 300 (N-111)	<100	<100	<30
Recommended controller	E-755, E-712 Motion Controller incl. driver	E-862 driver, E-861 Motion Controller incl. driver	C-872 driver, C-867 Motion Controller incl. driver	E-870 driver, E-871 Motion Controller incl. driver

# PiezoWalk® Piezo Stepping Drives

Nanometer Precision with a High Feed Force



- Forces from 10 to 800 N
- Integration levels from an OEM motor to a multi-axis positioning system
- Scalable travel range due to scalable runner length
- Resolution to 0.03 nm
- Self-locking when at rest, no heat generation
- Nonmagnetic and vacuum-compatible operating principle

## Why PiezoWalk®?

PiezoWalk® drives were developed more than 10 years ago for the semiconductor industry, which is very demanding when it comes to reliability, position resolution and long-term stability. PI received the SEMI Technology Innovation Showcase Award for the PiezoWalk® technology in 2005. The drives are continuously developed further, and a large number of variants are now available for different areas of application.

## Directly Driven PiezoWalk® Linear Motors

As essential components, these piezo stepping drives have several piezo actuators that are preloaded against a guided runner. These piezo actuators perform a stepping motion during operation that causes a forward feed of the runner. The piezo actuators can be operated to perform very small stepping and feed motions so that a high motion resolution of far below one nanometer is achieved.

Piezo stepping drives do not require any mechanical components such as coupling or gearhead, which cause friction and backlash and would considerably limit the precision and reliability of high-resolution motor-spindle-based drive systems.

## Stepping Motion Sequence

With PiezoWalk® stepping drives, piezo actuators work in pairs as clamping and feed elements on a moving runner. Cyclical control induces a stepping motion of the actuators on the runner, and the runner is moved forwards and backwards.

With NEXLINE® drives, the stepping motion is realized via separately controlled, powerful longitudinal and shear actuators, achieving a high stiffness with feed forces of several 100 N. The more compact NEXACT® drives perform the stepping motion with bending elements.

A suitable selection of the piezo elements optimizes step size, clamping force, velocity and stiffness for the respective requirements.

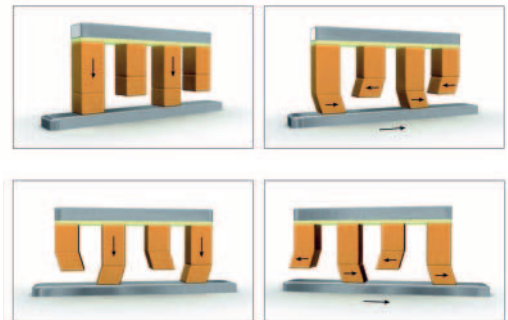

Motion sequence of a NEXLINE® actuator

## Piezomotors are Self-Locking

Preloading the piezoceramic actuators against the runner ensures self-locking of the drive when at rest and switched off. As a result, it does not consume any power, does not heat up, and keeps the position mechanically stable. Applications with a low duty cycle that require a high time and temperature stability profit from these characteristics.

## Lifetime and Reliability

The motion of the piezoceramic actuator is based on crystalline effects and is not subject to any wear. Unlike other piezomotor principles, the coupling of the piezo actuators to the runner is not subject to sliding friction effects; the feed is achieved by the physical clamping and lifting of the actuators.

## Piezomotors for Applications – e.g. in a Vacuum and in Strong Magnetic Fields

Piezomotors from PI are vacuum-compatible in principle and suitable for operation under strong magnetic fields. For these purposes,

special versions of the drives are offered. Piezo stepping drives can also be used in clean rooms or in environments with a hard ultraviolet radiation.

## Two Technologies for More Flexibility

For the piezo stepping drives, PI uses two different technologies that can be adapted to the respective requirements. NEXLINE® stepping drives are designed for high push and holding forces up to 800 N and work with low velocities. The more compact NEXACT® drives achieve higher velocities and develop forces from 10 to 20 N.

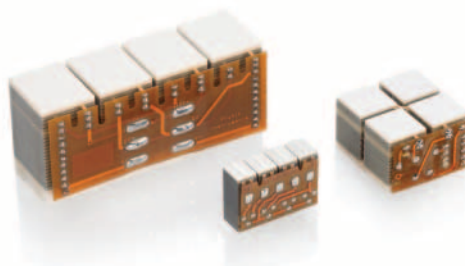
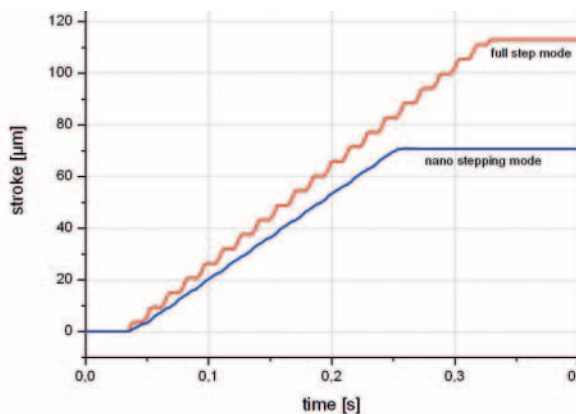

Various designs and sizes of NEXLINE® modules (left and right) as well as NEXACT® (center)

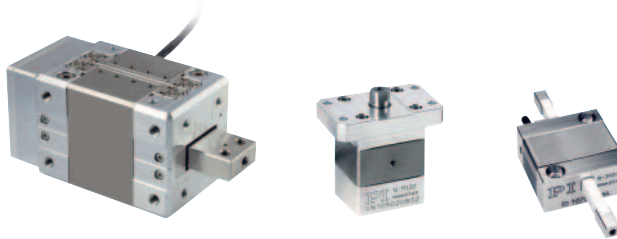

Constant velocity and smooth driving of a NEXLINE® drive are best achieved in nanosteping mode, but the maximum attainable velocity is higher in full-step mode

OEM piezomotors (from left): N-216 and N-111 with NEXLINE®, N-310 with NEXACT® drives

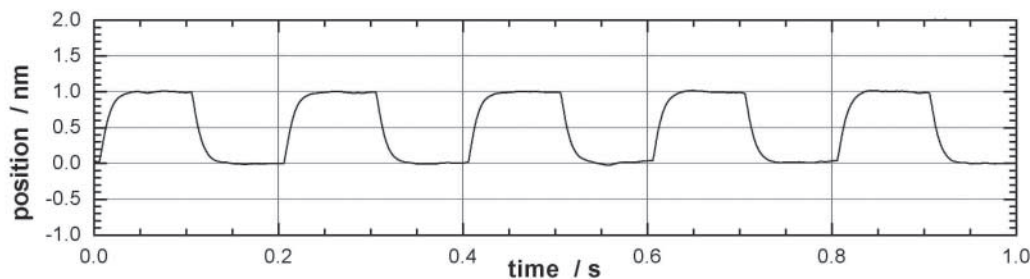

Sequence of open-loop 1 nm motions of a NEXLINE® drive

# PILine<sup>®</sup> Ultrasonic Piezomotors

## Compact Drives, Fast and Self-Locking

- Integration levels from an economical OEM motor to a multi-axis positioning system
- Excellent dynamic properties, fast step-and-settle
- Basically unlimited travel ranges
- Easy mechanical integration
- Self-locking at rest
- Holding force up to 15 N
- Velocity up to 500 mm/s
- Resolution to 0.05  $\mu\text{m}$  (50 nm)



### Direct-Driven PI Line<sup>®</sup> Linear Motors

These linear drives dispense with the mechanical complexity of classical rotary motor/gear/leadscrew combinations in favor of costs and reliability.

These components can be very susceptible to wear, especially in miniaturized systems. An integral part of the ultrasound piezomotor is piezo ceramics that is pretensioned against a movably guided runner via a coupling element. The piezo element is excited to high-frequency oscillations that cause the runner to move.

### Piezomotors are Self-Locking

Preloading the piezoceramic actuators against the runner ensures self-locking of the drive when at rest and powered down. As a result, it does not consume any power, does not heat up, and keeps the position mechanically stable. Applications with a low duty cycle, that are battery-operated or heat-sensitive benefit from these characteristics.

### Lifetime and Reliability

The motion of the piezoceramic actuator is based on crystalline effects and is not subject to any wear. The coupling to the runner, on the other hand, is subject to friction effects. Depending on the operating mode, running distances over 2 000 km or a MTBF of 20 000 hours are achieved.

### Dynamics in Use

The stiff design, direct coupling and fast response of the piezo ceramics to electric inputs allows for very fast start / stop behavior and velocities to hundreds of mm/s.

### Patented Technology

The products described in this document are in part protected by the following patents:

US patent no. 6,765,335B2

European patent no. 1267425B1

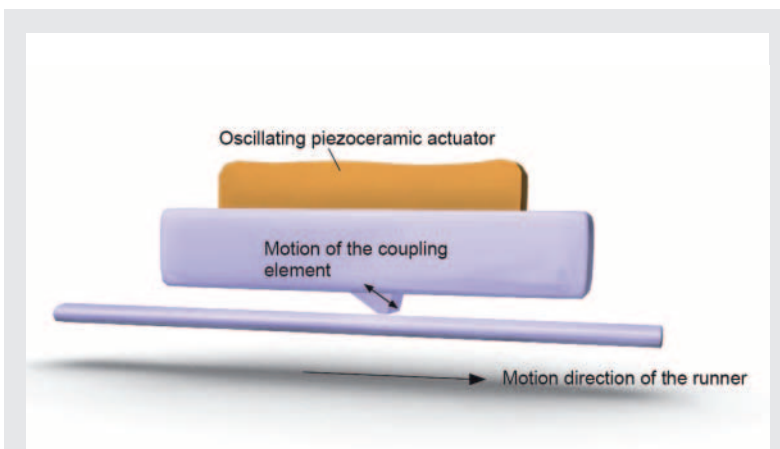

The piezoceramic actuator is excited to ultrasonic vibrations with a high-frequency AC voltage between 100 and 200 kHz. The deformation of the actuator leads to a periodic diagonal motion of the coupling element to the runner. The created feed is roughly 10 nm per cycle; the high frequencies lead to the high velocities

# PILine® Ultrasonic Piezomotors

## OEM Motors, Technical Data

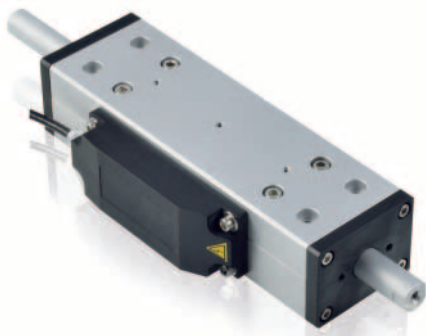

PILine® integration levels (left to right): M-272 closed-loop, guided linear actuator, OEM motor and U-264 RodDrive low-profile actuator (unguided)

### Different Integration Levels Offer Flexibility

PILine® drives allow the design of positioning systems with higher dynamics and smaller dimensions. PI offers various integration levels of PILine® drives for easier integration into customer designs:

- Positioning stages with integrated PILine® drives, available in customized designs for OEM
- Linear actuators move the load via a guided rod. Position feedback is available as an option

- RodDrives are unguided, open-loop linear drives that replace motor-leadscrew combinations. They can easily be coupled to a guided positioning platform
- The integration of OEM motors requires more experience and technical knowledge because the optimal preload between runner and actuator has to be set up by the customer

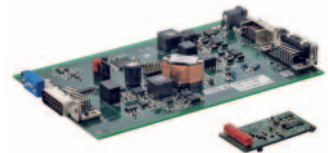

### Drive Electronics

To produce the ultrasound oscillations in the piezo actuator, special drive electronics are required that are also provided by PI. These range from OEM boards to integrated servo controllers for closed-loop systems.

Drive electronics create the ultrasonic vibrations for the piezoceramic actuator of the PILine® drive. PI offers universal drivers for all actuator sizes – as well as specialized, compact boards

Motion and positioning	P-661	U-164	Unit	Tolerance
Travel range*	No limit	No limit	mm	to 1 mm
Min. incremental motion, open-loop**	0.05	0.05	µm	typ.
Velocity (open-loop)	500	500	mm/s	max.
<b>Mechanical properties</b>				
Stiffness, de-energized	0.7	3	N/µm	±10 %
Holding force, de-energized	1.5	3	N	max.
Push / pull force	2	4	N	max.
Preloading on friction bar	9	18	N	±10 %
Integration effort	average	low		low
<b>Drive properties</b>				
Resonant frequency	210	155	kHz	±2 kHz
Motor voltage	42 V <sub>rms</sub> (120 V <sub>pp</sub> )	60 V <sub>rms</sub> (170 V <sub>pp</sub> )		
<b>Miscellaneous</b>				
Operating temperature range	-20 to +50	-20 to +50	°C	
Casing material	Aluminum, anodized	Aluminum, anodized		
Weight	10	20	g	±5 %

\* The travel range of piezo linear motors is practically unlimited. It only depends on the length of the runner

\*\* The minimum incremental motion is a typical value which can be reached in open-loop operation. However, it is important to follow the installation guidelines for the motors

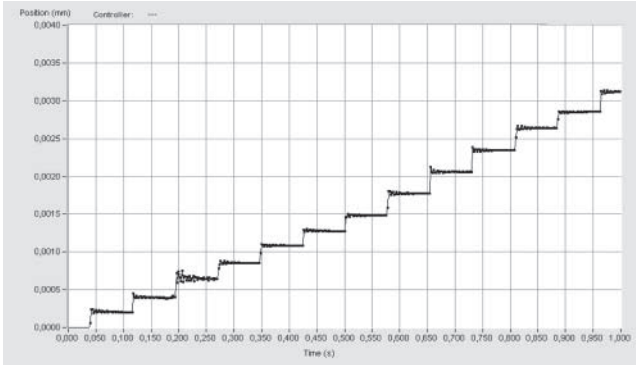

Open-loop step sequence of a PILine® based translation stage. Steps of approx. 300 nm shown. For repeatable increments closed-loop operation is recommended, because the step size depends on the force applied from outside

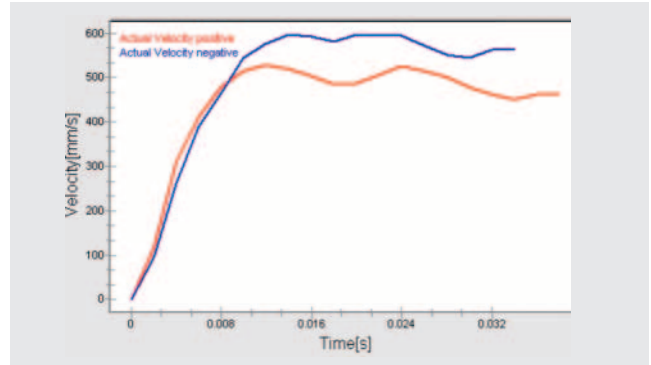

PILine® ultrasonic linear motors provide excellent dynamic properties. They provide acceleration to several g and can achieve step-and-settle of a few 10 microseconds for small distances

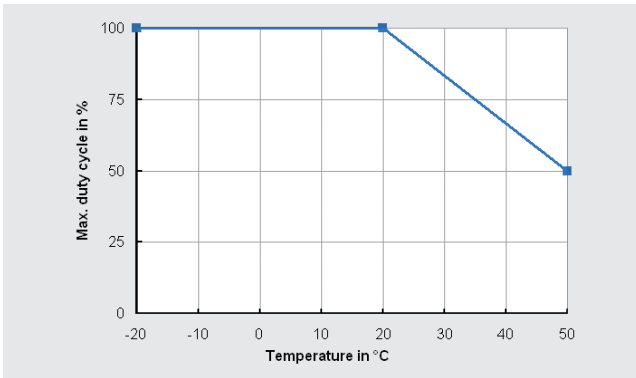

Maximum duty cycle depending on the ambient temperature with a control signal level of 100%

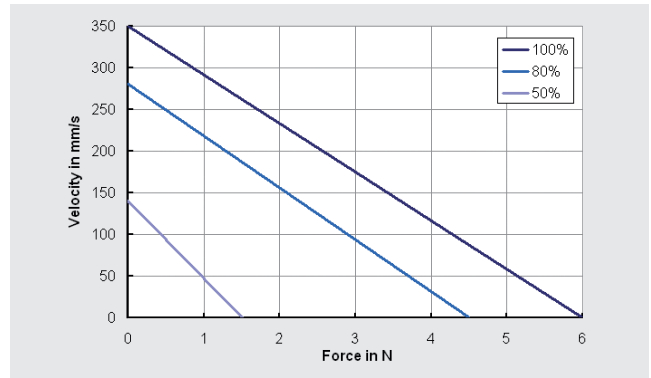

Force / velocity motor characteristic of a PILine® motor 6 N holding force. The percentages refer to the control signal level, which denotes the coupling of the electric power of the actuator

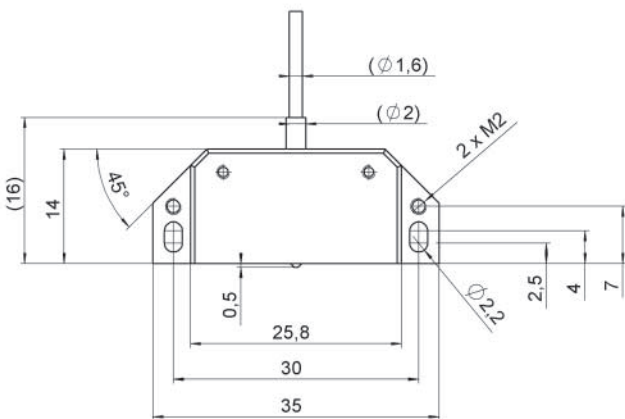

108 P-661, dimensions in mm

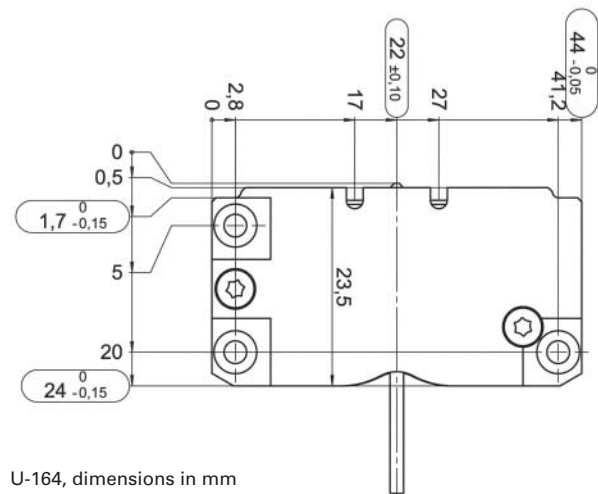

U-164, dimensions in mm



# PIShift Piezo Inertia Drives

## Cost-Efficient, Compact Linear Motors

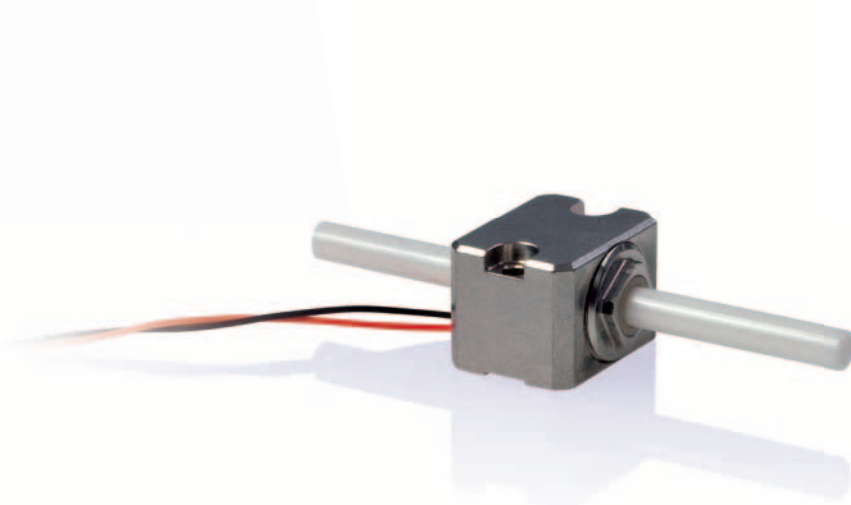

- From OEM drives to integration into a multi-axis positioning system
- Basically unlimited travel ranges
- Easy mechanical integration
- Self-locking at rest
- Holding force up to 10 N
- Velocity of more than 5 mm/s
- Simple, cost-efficient control

PIShift drives are space-saving and cost-efficient piezo-based drives with relatively high holding forces of up to 10 N and a basically unlimited travel range. They make use of the stick-slip effect (inertia effect) – a cyclical alternation of static and sliding friction between a moving runner and the drive element generated by the piezo element – for a continuous feed of the runner. With an operating frequency above 20 kHz, PIShift drives reach velocities of more than 5 mm/s.

### Silent and Energy-Saving

The drive works silently at this frequency. When at rest, the drive is self-locking and therefore requires no current and generates no heat. It holds the position with maximum force.

### Easy Integration

For easy integration, the drive component is either mounted on a level surface or screwed in on the front. The load is coupled to the moving runner. Compact drive electronics are available in single or multi-channel versions and can be controlled via analog or digital interfaces. The piezo drive element in the actuator requires less than 50 V operating voltage.

A full cycle produces a feed of typically 300 nanometers. The mechanical components are designed so that there is minimum backstep during the fast contraction

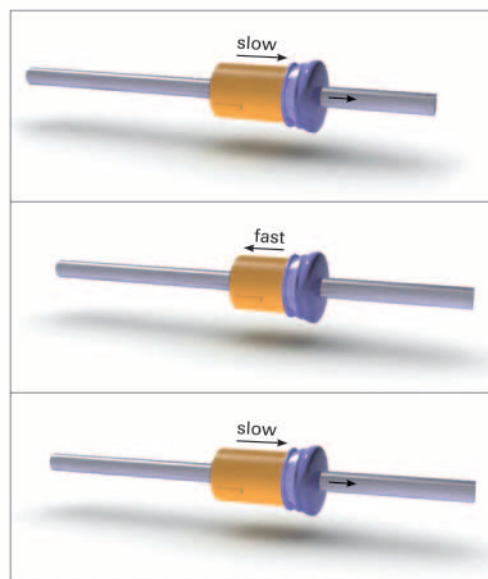

The PIShift drive principle is based on a single piezo actuator that is controlled with a modified sawtooth voltage provided by a special drive electronics. The actuator expands slowly taking along the runner. When the piezo element contracts quickly, the runner cannot follow due to its inertia and remains at its position

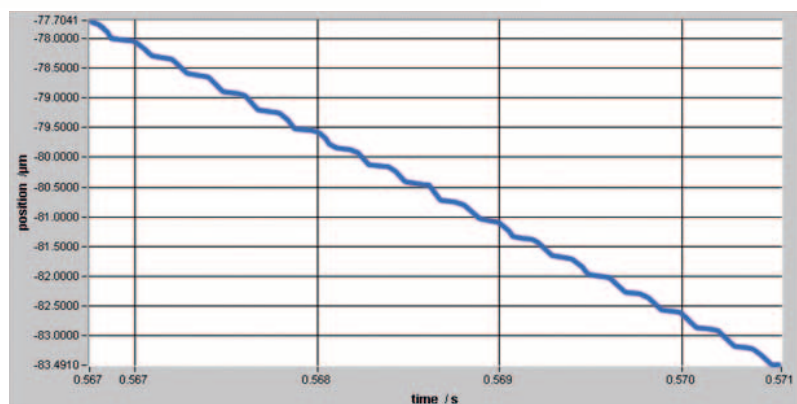

# Piezo Actuators with Guiding and Preload

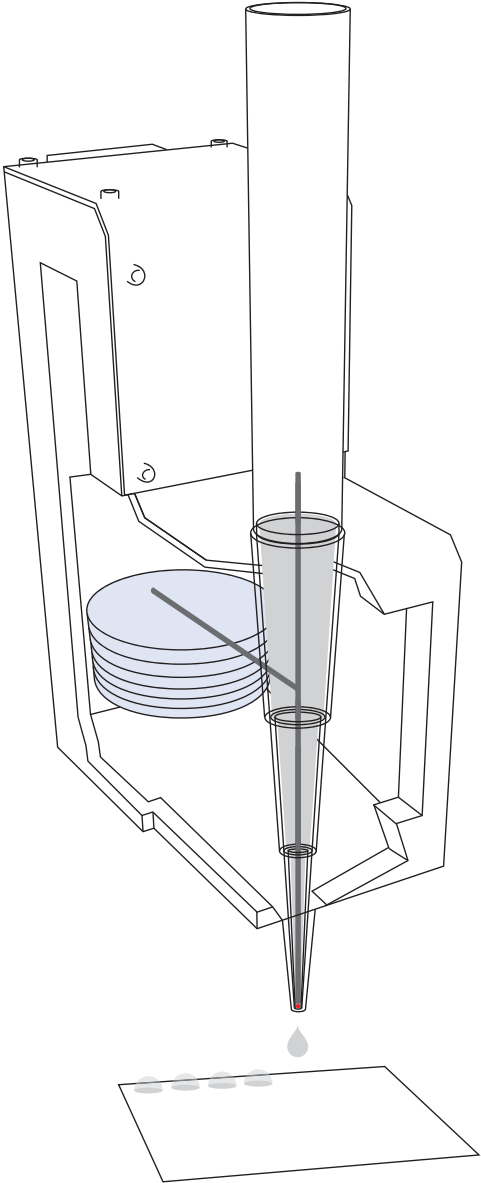

Translation actuators with and without preload can be inserted into microvalves while for larger travel ranges lever-amplified drive systems are suitable



**PiezoMove® Flexure Actuators**  
 Guided and Preloaded PICMA®  
 Multilayer Lever-Amplified Piezo Actuators

**Page 112**



**Preloaded Piezo Stack Actuators**  
 for Dynamic Applications

**Page 114**

**Technology: Guiding and Preload**

**Page 116**

	Piezo Stack Actuators	PiezoMove® Flexure Actuators
Travel ranges	up to approx. 300 µm	to 1 mm
Moving axes	one	one
Sensor technology	optional SGS	optional SGS
Linearity	up to 99.8 %	up to 99.8 %
Guiding	none	flexure joints for tilts <10°
Space requirement	low	low
Price	low	low
Integration effort	average	low

# PiezoMove® Flexure Actuators

Guided and Preloaded PICMA®  
Multilayer Lever-Amplified Piezo Actuators

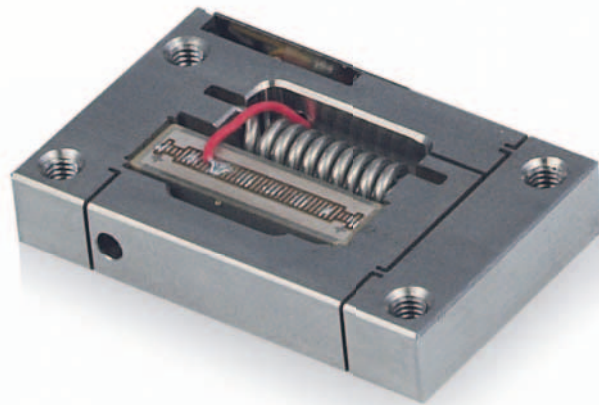

P-603  
PiezoMove®  
Flexure Actuator

## Highlights

- Sub-millisecond response time and sub-nanometer resolution
- Versions with SGS sensors for repeatabilities of only a few nanometers
- Cost-efficient OEM solutions for integration
- For high quantities

## Applications

For valves, pumps, micro- and nanoliter dosing, active vibration insulation, sample handling and imprint technologies in microfluidics, biotechnology, medical technology, mechatronics, adaptive systems technology or metrology.



P-601

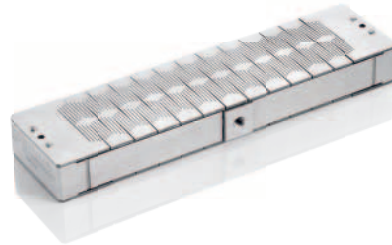

P-602



P-604

	P-601	P-602	P-603	P-604
Dimensions in mm	16.5 × 12 × 16.5 to 82.5 × 12 × 20.5	28 × 17 × 9 to 126 × 34 × 14	33.5 to 62 × 21 × 6	19.5 × 13 × 3
Travel range in μm	100 to 400	100 to 1000	100 to 500	300
Push force capacity in motion direction in N	15 to 30	100	10 to 40	2
Pull force capacity in motion direction in N	10	5	10 to 20	1.5
Unloaded resonant frequency in Hz	350 to 750	150 to 1000	300 to 900	900
Electrical capacitance in μF	1.5 to 5	1.5 to 39	1.5 to 3.7	0.27
Operating voltage range in V	-20 to 120	-20 to 120	-20 to 120	-20 to 120
Versions with SGS position sensor	available	available	available	–
Recommended controller	E-610, E-625, E-709	E-610, E-625, E-709	E-610, E-625, E-709	E-610, E-831

# Preloaded Piezo Stack Actuators

For Dynamic Applications



P-216  
PICA Power  
Piezo Actuator

## Highlights

- Sub-millisecond response time and sub-nanometer resolution
- Compact stainless steel case with variable end pieces
- High stiffness
- UHV versions
- Versions with SGS positioning sensor available

## Applications

Highly dynamic applications that also have high precision and force generation requirements can be found in precision mechanical engineering, in material processing, material forming and others. They include switching and dosing tasks as well as active compensation of vibrations. Versions for vacuum of up to  $10^{-9}$  hPa, particularly high or low operating temperatures are available.

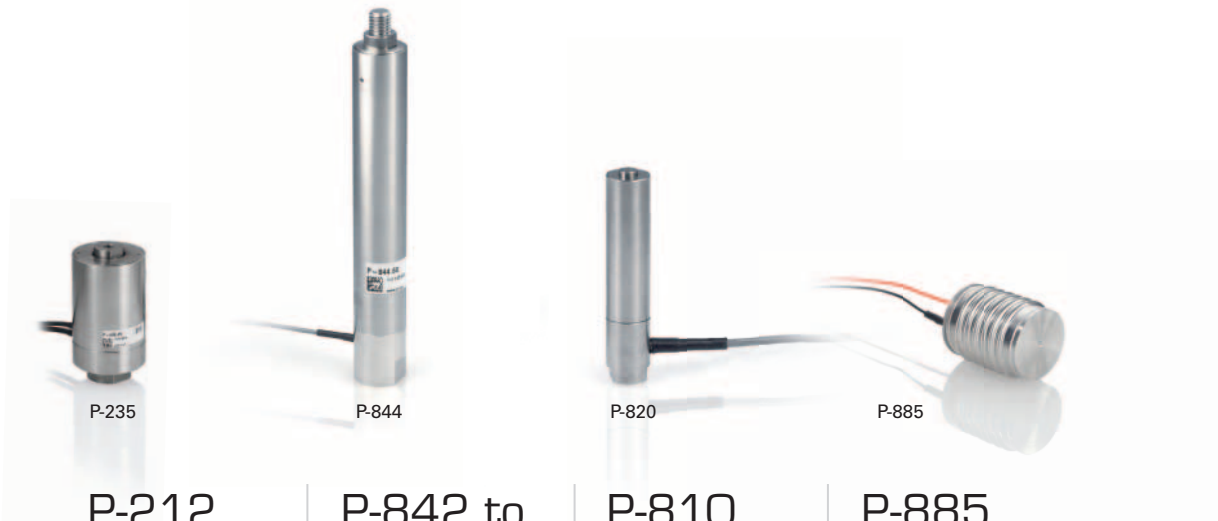

P-212  
P-216  
  
P-225  
P-235

P-842 to  
P-845  
  
P-840  
P-841

P-810  
P-830  
  
P-820

P-885  
P-888

	PICA Stack actuators for maximum force generation	PICMA® Stack multilayer actuators	PICMA® Stack multilayer actuators	Encapsulated PICMA® Stack multilayer actuators for use in rough environment
Dimensions in mm	Ø 18 to 50 length of up to 199	Ø 12 to 19 length of up to 137	Ø 5.5 to 10 length of up to 76	Ø 11.2 to 18.6 length of up to 40.5
Operating voltage range in V	0 to 1000	-20 to 120	-20 to 120	-20 to 120
Travel range in µm	15 to 180	15 to 90	15 to 60	17 to 36
Push force capacity in motion direction in N	2000 to 30000	800 to 3000	50 to 1000	800 to 3000
Pull force capacity in motion direction in N	300 to 3500	50 to 700	1 to 10	-
Unloaded resonant frequency in Hz	up to 17	5 to 18	8 to 22	35 to 60
Electrical capacitance in µF	0.05 to 8	1.5 to 36	0.3 to 6	1.5 to 6
Recommended controller	E-481, E-421	E-610, E-621, E-709	E-610, E-621, E-709	E-831, E-610

# Technology:

## Piezo Actuators with Guiding and Preload

Simple lever amplification. The point contact decouples shear forces and thus tensile stress on the piezo ceramic

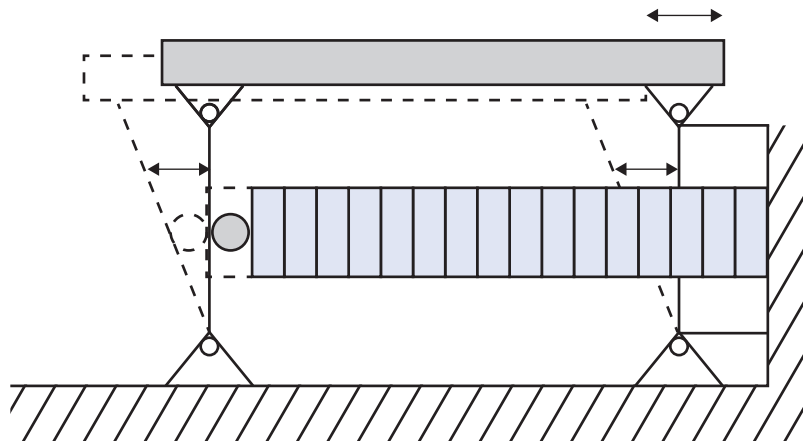

### Preloaded and Cased Actuators

Piezoceramic actuators are insensitive to push forces, but must be protected from pulling and shearing stress. A case mechanically decouples lateral forces and insulates contacting. Between the case and the piezo ceramic, a preload can be applied, e.g. by means of a spring, which allows dynamic operation of higher loads.

### Flexure Guides Direct Motion and Maintain Stiffness

Precise straight motions require the piezo actuator to be embedded in a guide. This is usually a flexure guide, which is frictionless and allows hysteresis-free motion at the possible travel ranges of up to a few millimeters. Ideally this mechanical guiding concept also integrates force decoupling and preloading without an adverse effect on the system stiffness.

### Lever Amplification Allows Travel Ranges of up to 1 mm

The displacements of piezo stack actuators are typically up to a few ten millimeters and a few 100 micrometers maximum. The flexure guide can be designed such that it will act like a mechanical lever. This mechanically amplifies the displacement of the piezo actuator and guides it into a different direction, if necessary.

Lever-amplified systems have an extremely demanding design: On the one hand, they are supposed to prevent lateral migration and, on the other, to always guide it in a straight line, even though the lever always leads through a pivot point. Moreover, increasing the travel range is at the cost of stiffness.

The flexure guide can be designed such that further integration does not require any additional guide.

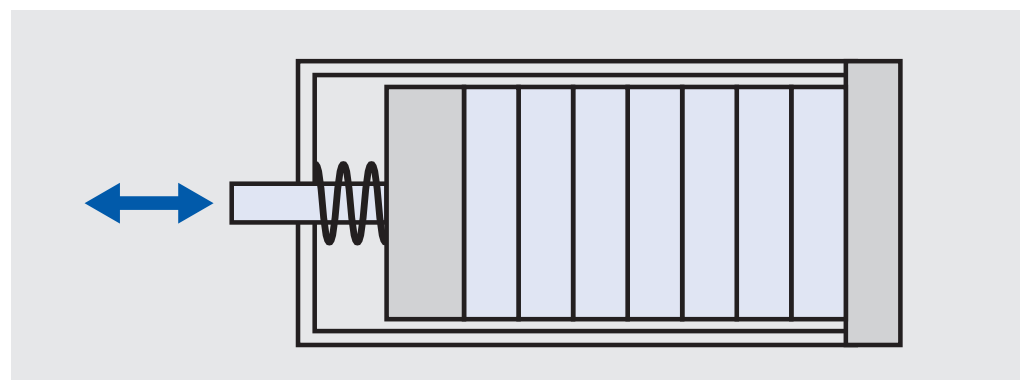

The piezo ceramic stack is mechanically preloaded against the housing by means of a spring. This prevents pull forces, such as the ones caused by the inert mass of the load in dynamic operation



## From Stack Actuator to 6-Axis Stage

Integration levels of piezo actuators

	Stack Actuators	Lever-Amplified Actuators	Positioning Systems
Travel ranges	up to approx. 300 $\mu\text{m}$	to 1 mm	to 1 mm
Moving axes	one	one	up to 3 linear axes and 3 tip/tilt axes
Sensor technology	optional SGS	optional SGS	SGS or direct measuring capacitive sensors
Linearity	up to 99.8 %	up to 99.8 %	more than 99.9 %
Guiding	none	flexure joints for tilts $<10^\circ$	flexure joints for tilts $<2^\circ$
Space requirement	low	low	depending on configuration
Price	low	low	depending on configuration
Integration effort	average	low	low

### PiezoMove® OEM Flexure Actuators with Built-In Guiding

PiezoMove® actuators combine guided motion with long travel ranges of up to 1 mm and provide precision in the 10 nanometer range if ordered with the position sensor option. Their high-precision, frictionless flexure guides achieve very high stiffness and excellent straightness of motion. This makes them easier to handle than a simple piezo actuator, but still keeps them extremely compact. The number and size of the piezo actuators used determine stiffness and force generation.

These features, their small dimensions and cost-efficient design make PiezoMove® flexure actuators suitable in particular for OEM applications. For open-loop applications, versions without sensors are available.

In addition to the standard steel models, special invar and nonmagnetic versions are available on request.

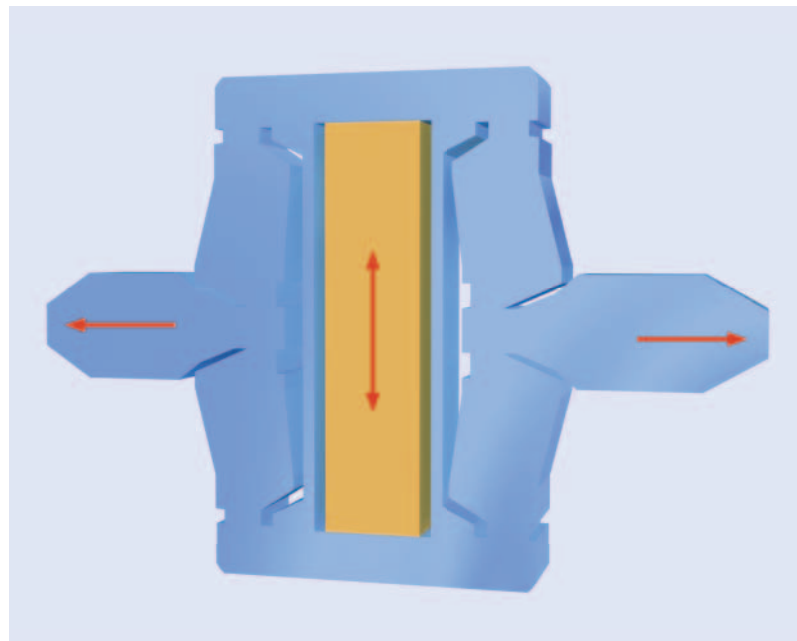

This lever mechanism with flexure guides transforms the actuator travel range (vertical) to an even, straight motion (horizontal)

# Piezo Actuators and Piezo Components

Direct Drives for Precision Positioning and Precision Production, Micro Dispensing Systems, Switching Applications, Force and Vibration Generation

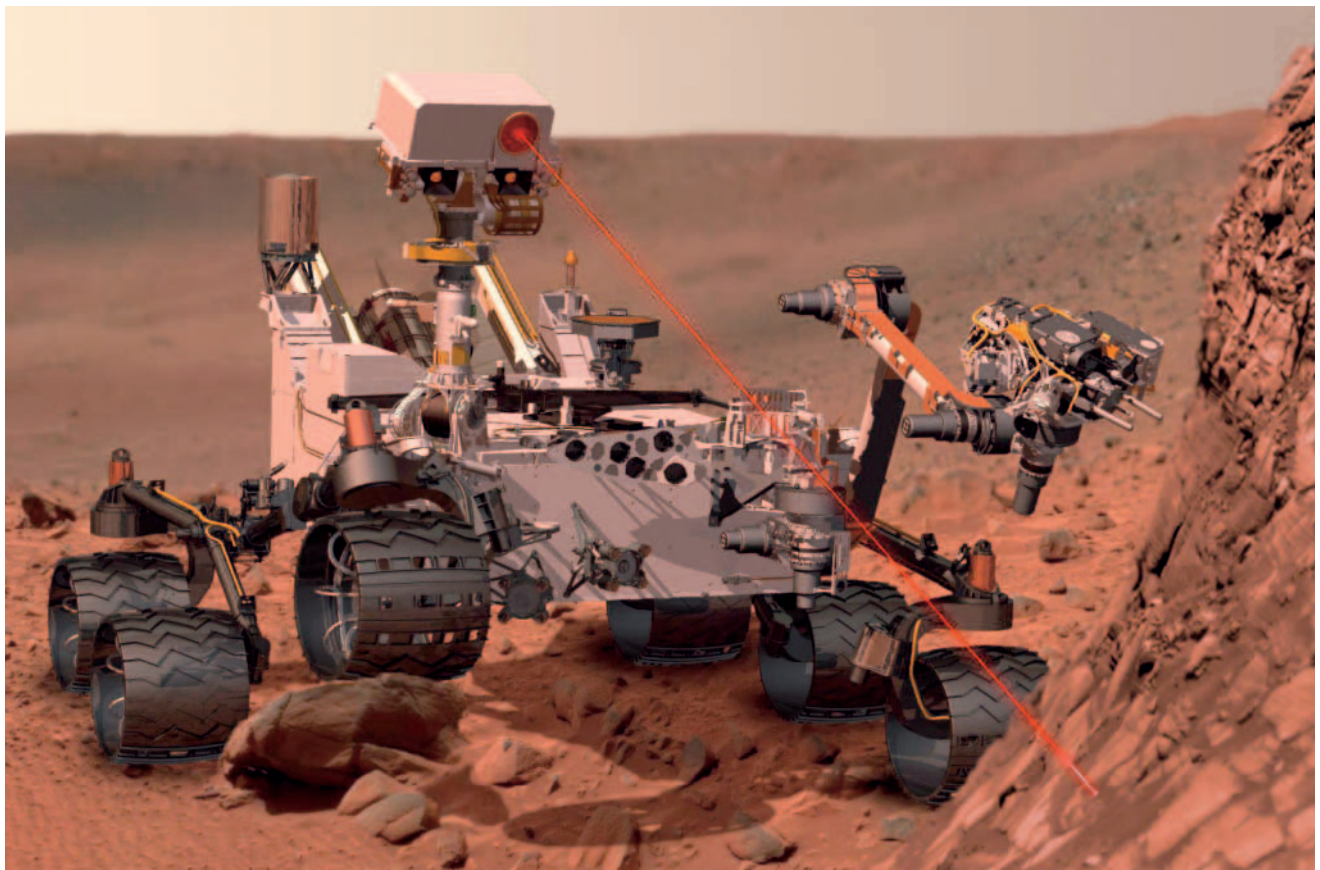

Currently PICMA<sup>®</sup> actuators are being used in the CheMin Instrument of the Mars Rover Curiosity. In dynamic tests carried out by NASA for the Mars Mission, PICMA<sup>®</sup> actuators have withstood 100 billion operating cycles without failures and without any significant loss in power (Picture: NASA/JPL)



**Longitudinal Piezo Actuators / Translators**  
 Multilayer Technology or Glued Stack Actuators

Page 120



**PICMA® Bender Multilayer Actuators**  
 All-Ceramic Bending Actuators with High Displacement

Page 122



**Unguided Piezo Actuators**  
 And Piezo Components

Page 124

## Flexible Adjustment of Actuators and Components

PI Ceramic is one of the worldwide leading manufacturers of piezo technology. Their in-house development laboratories and installations for prototype construction and for testing the finished elements allow quick and flexible adjustment of the standard products to special fields of application. Our pressing and multilayer technology enables us to shape products with a short lead time. This also allows large series of up to several 100 000 units per year to be produced.

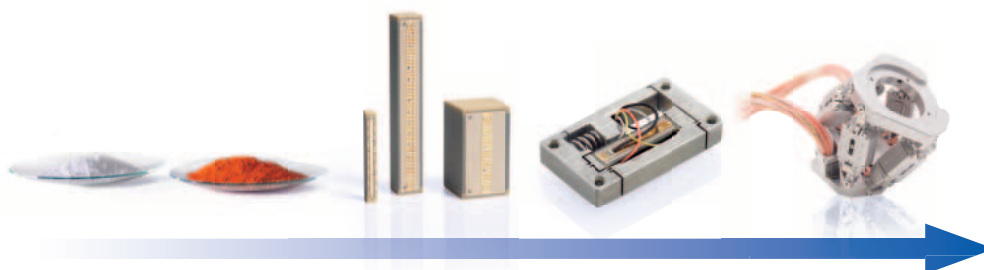

The in-house manufactured PICMA® multilayer piezo actuators combined with high-precision sensors and mechanical design are the basic element. The control electronics and software especially developed by PI convert these products into first-class nanopositioning systems

# Longitudinal Piezo Actuators / Translators

## Multilayer Technology or Glued Stack Actuators

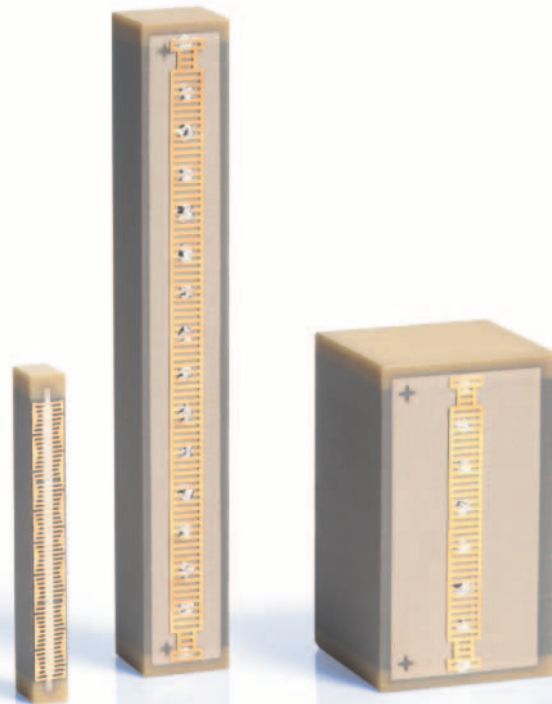

PICMA®  
Multilayer Piezo Actuators

## Highlights

- Sub-millisecond response time and sub-nanometer resolution
- High stiffness
- Variable end pieces
- UHV versions
- Optionally with SGS sensors for position control

## Applications

The reliability of PI piezo actuators is required in many areas: In semiconductor industry, precision mechanics and production as well as for switching applications and valve control, e.g. in automotive industry. Piezo actuators are also used in active vibration damping, nanotechnology, metrology, optics and interferometry.

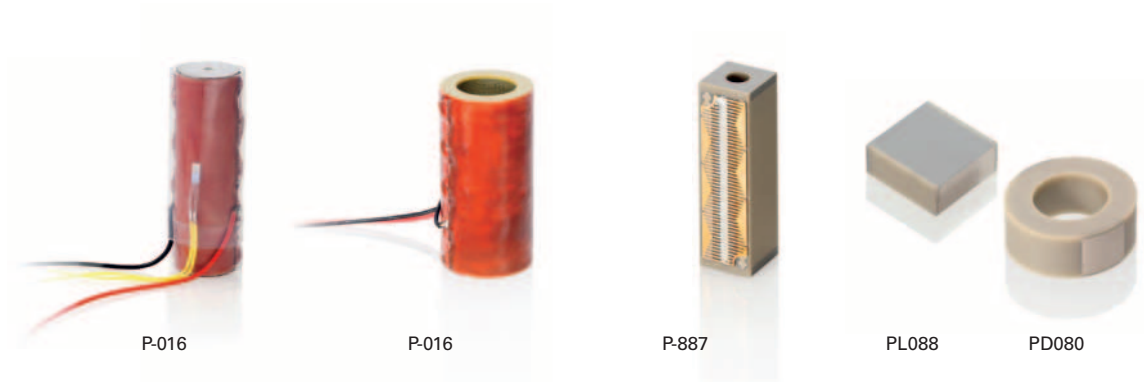

P-010...P  
to  
P-056...P

P-010...H  
to  
P-056...H  
P-007 to  
P-056

P-882 to  
P-888

PL022 to  
PL088  
PD050  
PD080

	PICA Power high-load stack actuators	PICA Thru and PICA Stack actuators with and without inner hole	PICMA® Stack multilayer piezo actuators with and without inner hole	PICMA® Chip miniature multilayer actuators, also available ring-shaped
Cross-section in mm	Ø 10 to 56	Ø 7 to 56 hole up to 16	2 x 3 to 10 x 10	2 x 2 to 10 x 10 or Ø 8 x 2.45
Length in mm	9 to 169	8 to 244	9 to 36	2
Operating voltage range in V	0 to 1000	0 to 1000	-20 to 120	-20 to 120
Travel range in µm	5 to 180	5 to 300	5 to 38	2
Blocking force in N	1 200 to 78 000	650 to 78 000	190 to 3 800	120 to 2 000
Unloaded resonant frequency in Hz	7 to 130	5 to 125	40 to 135	600
Electrical capacitance in µF	0.017 to 21	0.011 to 27	0.15 to 13	0.025 to 1.1

# PICMA<sup>®</sup> Bender Multilayer Actuators

All-Ceramic Bending Actuators with High Displacement

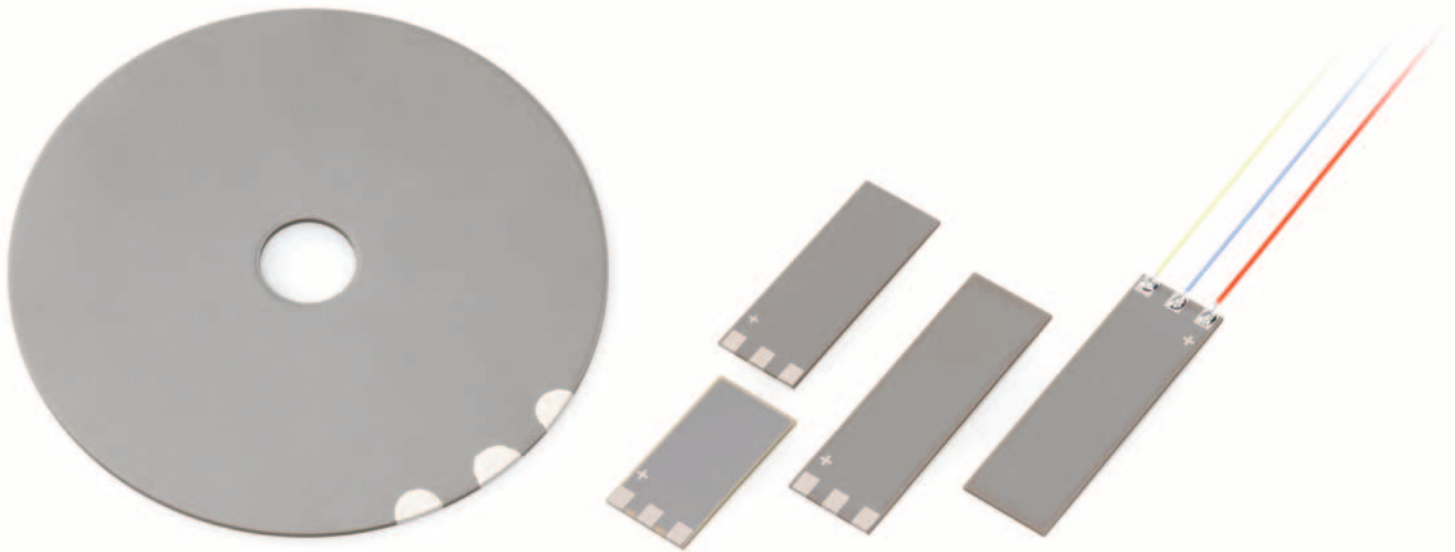

PICMA<sup>®</sup>  
Bender Actuators

## Highlights

- PICMA<sup>®</sup> multilayer technology in bimorph structure
- Bidirectional, symmetrical displacement
- Low operating voltage
- UHV versions

## Applications

Their reliability and low operating voltage make PICMA<sup>®</sup> bending actuators ideal for dosing and pumping applications, for optical beam deflection, and when minimally dimensioned, for use in portable devices. There the piezo elements can be used, for example, as acoustic-mechanical converters.

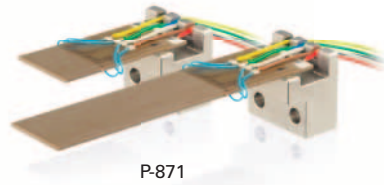

P-871

PL112  
to  
PL140  
PD410

P-871

### Application-Specific Designs

Completely assembled to customer requirements  
For particularly compact OEM solutions

### Multilayer Contracting Plates

Can be manufactured in round (as disk) or rectangular shape (as plate)  
For application to a metal or silicon substrate

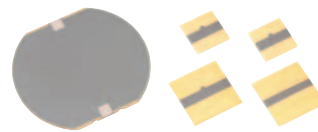

### Piezo Element Applied to a Passive Substrate

Unidirectional displacement, resulting in higher stiffness and larger relative displacement

### Any Desired Contours

Also available with all-ceramic insulated hole

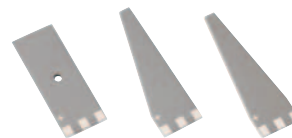

### Variable Height of the Active Layers

Up to 15  $\mu\text{m}$  for a control voltage of only 10 V

### Miniature Designs

Only 4 x 10 mm<sup>2</sup> in edge length



	UHV-compatible up to 10 <sup>9</sup> hPa	PICMA <sup>®</sup> Bender actuators with SGS position sensor
Dimensions in mm	18 x 10 x 0.65 to 45 x 11 x 0.60 Ø 44 x 0.65	22 x 10 x 0.65 to 49 x 11 x 0.60
Operating voltage range in V	0 to 60	0 to 60
Displacement in $\mu\text{m}$	$\pm 80$ to $\pm 1000$	$\pm 80$ to $\pm 1000$
Blocking force in N	$\pm 0.5$ to $\pm 2$	$\pm 0.5$ to $\pm 2$
Unloaded resonant frequency in Hz	160 to 2000	160 to 2000
Electrical capacitance in $\mu\text{F}$	2 x 1 to 2 x 4	2 x 1 to 2 x 4
Recommended controller/driver	E-650	E-651, E-614

# Unguided Piezo Actuators

## And Piezo Components



## Highlights

- DuraAct piezo patch transducer for application to structural materials
- PTTube piezo tubes for microdosing, micromanipulation and scanning applications
- Compact PICA Shear actuators for displacement in up to 3 axes
- Lead-free piezo actuators in Picoactuator<sup>®</sup> technology
- Large choice of designs

## Applications

The products are just as variable as the applications: DuraAct piezo transducers are used for condition monitoring and adaptive systems. Piezo tubes are suitable for microdosing using, for example, jet technology, as micro- and nano-manipulators and as fiber stretchers. PICA Shear actuators are among the smallest XYZ positioning devices and are available in versions for cryogenic environment of down to -269°C and vacuum of as high as  $10^{-9}$  hPa. The crystalline Picoactuator<sup>®</sup> exhibits highly linear displacement even without servo loop, allowing it to use the full dynamic range for positioning operations.



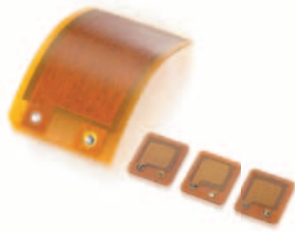

P-876

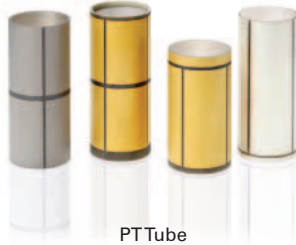

PTube

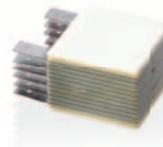

P-141



P-405

## P-876

## PT Tube

## P-111 to P-151

## P-405

	P-876	PT Tube	P-111 to P-151	P-405
	DuraAct Piezo transducer for use as actuator and sensor	Piezo Tube actuators for radial, lateral and axial displacement	Highly reliable PICA Shear actuators	Picoactuator® made of lead-free crystalline material
Available designs	Available in different forms and dimensions or as array	UHV-compatible versions up to 10 <sup>-9</sup> hPa	X, XY, XZ and XYZ versions Versions for cryogenic and UHV environments	Longitudinal and shear actuators
Operating voltage range in V	-50 to +200, -100 to +400 or -250 to +1000	0 to 1000 or ±250	-250 to 250	±500
Travel range in µm	Lateral contraction up to 800 µm/m. Displacement depending on the structural material	5 to 15 axial, ±10 to ±35 lateral	1 to 10	1
Blocking force in direction of travel in N	90 to 800	–	–	–
Unloaded resonant frequency in Hz	–	–	30 to 530	up to 160
Electrical capacitance in nF	up to 150	3 to 70	0.2 to 230 per axis	<4
Cross-section in mm	61 × 35	∅ 2.2 to 40	3 × 3 to 16 × 16	5 × 5 to 10 × 10
Length in mm		20 to 40	3.5 to 40	up to 19
Recommended controller/driver	E-835, E-413 for actuator applications E-821 for energy harvesting	–	E-508, E-413, E-536	E-421



# Hexapod and SpaceFAB

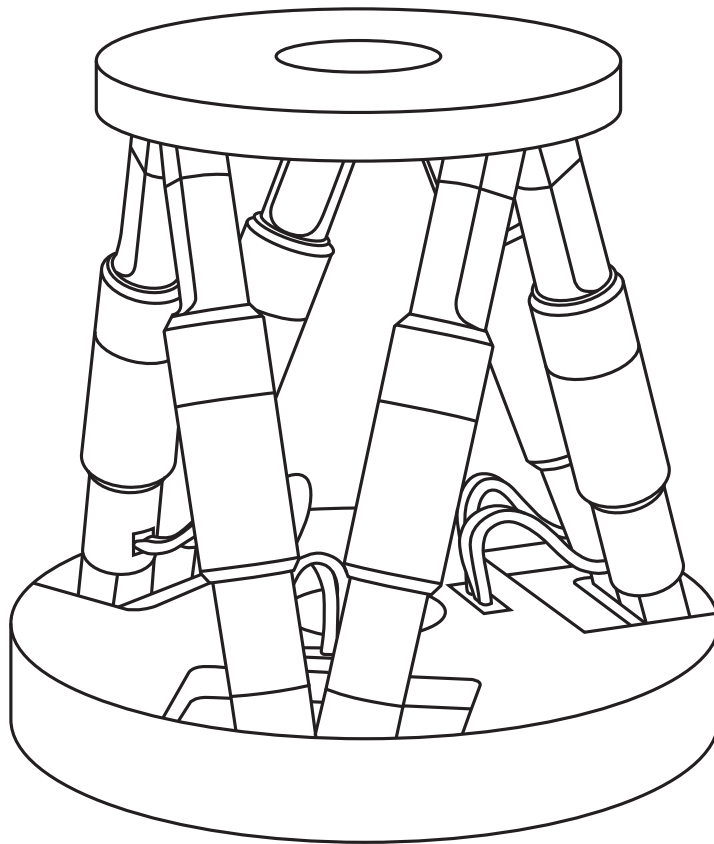

---

**Products**

**Page 160–179**

---

**Technology of Parallel-Kinematic Precision Positioning Systems**

**Page 180–189**

---

# Hexapod and SpaceFAB

Parallel Kinematics with 6 Motion Axes



In the ALMA project (Atacama desert, Chile), up to 64 antennas are combined to form a virtual single giant radio telescope. PI Hexapod systems are used to position the secondary reflectors of the antennas. The systems, which are specially designed for extreme ambient conditions, can position loads of up to 75 kg (Photo: ALMA (ESO/NAOJ/NRAO))



## Hexapod and SpaceFAB

Page 162



## Controller for Hexapod Positioning Systems

6-D Vector Motion Control, Comprehensive Functions

Page 176



## Accessories

For Hexapod Systems

Page 178

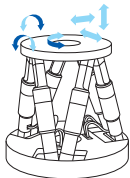

## Technology of Parallel-Kinematic Precision Positioning Systems

Page 180

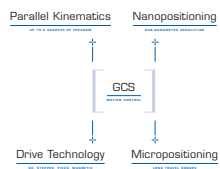

## Motion Control Software

Effective and Comfortable Solutions

Page 186

# Compact, High-Precision, Parallel-Kinematic Hexapods

---



H-811

## Highlights

- Six-axis positioning system with excellent precision
- System with powerful controller with vector algorithms, virtual pivot point
- Comprehensive software package with integrated scan algorithms for fiber optic alignment
- Optional interface for PLC control

## Applications

Automated 6D alignment systems assume important tasks for testing and manufacturing MEMS and photonics accessories. This includes positioning and aligning collimated fibers and assemblies.



F-206



H-810

H-206

H-811

H-810

	Ideal for fiber positioning	Vacuum-compatible version up to 10 <sup>-6</sup> hPa	
Dimensions in mm	228 × 220 × 158	Ø 136 × 115	Ø 100 × 116
Travel range X, Y, Z in mm	12 × 11 × 13	34 × 32 × 13	40 × 40 × 13
Travel range $\theta_x, \theta_y, \theta_z$ in °	11 × 13 × 11	13 × 13 × 42	20 × 20 × 60
Load capacity with horizontal/any mounting in kg	2	5 / 2.5	5 / 2.5
Repeatability X, Y, Z in $\mu\text{m}$	±0.3	±0.3, ±0.3, ±0.1	±1, ±1, ±0.1
Min. incremental motion X, Y, Z in $\mu\text{m}$	0.1	0.5, 0.5, 0.2	1, 1, 0.5
Max. velocity in mm/s	10	10	2.5

# Cost-Effective Hexapod Systems

For Medium Loads



H-840

## Highlights

- Six-axis positioning system with high precision
- System with powerful controller with vector algorithms, virtual pivot point
- Comprehensive software package
- Optional interface for PLC control

## Applications

These cost-efficient all-purpose 6-axis systems can be used for positioning and scanning in all degrees of freedom.



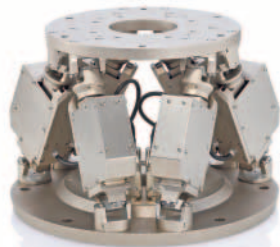

H-824



H-820

## H-824

## H-840

## H-820

	Precision Hexapod, vacuum-compatible versions up to 10 <sup>-6</sup> hPa	Precision Hexapod	Standard Hexapod for automation tasks in biotechnology and life sciences
Dimensions in mm	Ø 280 × 190	Ø 350 × 330	Ø 350 × 330
Travel ranges X, Y, Z in mm	50 × 50 × 25	100 × 100 × 50	100 × 100 × 50
Travel ranges $\theta_x, \theta_y, \theta_z$ in °	15 × 15 × 25	30 × 30 × 60	30 × 30 × 60
Load capacity in kg	5 to 10	10 to 30	20
Repeatability in $\mu\text{m}$	to $\pm 0.1$	to $\pm 0.4$	$\pm 20$
Min. incremental motion in $\mu\text{m}$	0.3 to 1	0.5 to 3	20
Max. velocity X, Y, Z in mm/s	1, 25	2.5, 50	20, with full load

# SpaceFAB Precision Micro Robot

6 Degrees of Freedom in Low-Profile Design



SF-450 PS

## Highlights

- Long travel ranges in X and Y with low-profile design
- Load of up to 3 kg
- Vacuum-compatible versions to  $10^{-9}$  hPa on request
- Modular structure for flexible travel ranges
- System with powerful controller with vector algorithms, virtual pivot point

## Applications

SpaceFAB designs can be adapted in a fast and uncomplicated way to meet customer requirements with regard to installation space or travel ranges. Therefore, the 6-axis systems are ideal for almost any precision application, from mini-positioners for UHV chambers to integration in production processes.



SF-3000



SF-6500 PS

## SF-3000

## SF-6500 PS

## SF-450 PS

Dimensions in mm	600 × 444 × 209	276 × 210 × 57	200 × 170 × 77
Travel range X, Y, Z in mm	50 × 50 × 12.7	13 × 13 × 10	12 × 12 × 6
Travel range $\theta_x, \theta_y, \theta_z$ in °	10	12 × 12 × 12	13 × 13 × 10
Load capacity in kg	3	2	0.4
Repeatability in $\mu\text{m}$	±0.5	±0.008	±0.25
Min. incremental motion in $\mu\text{m}$	0.2	0.005	0.025
Max. velocity in mm/s	30	10	10
Motor type	2-phase stepper motor	NEXACT® piezo stepping drive	PIShift piezo inertia drive

# Precision Hexapods

For Loads of up to 50 kg



HP-550

## Highlights

- Six-axis positioning system with excellent precision
- System with powerful controller with vector algorithms, virtual pivot point
- Comprehensive software package

## Applications

HP Hexapod systems include a powerful Delta Tau controller frequently used for automation in all fields of application. This includes positioning antennas in telescopes or production line control in semiconductor manufacturing.



HP-430



HP-300

## HP-550

## HP-430

## HP-300

Dimensions in mm	Ø 550 × 360	Ø 430 × 250	Ø 300 × 176
Clear aperture in mm	Ø 130	Ø 90	Ø 60
Travel range X, Y, Z in mm	100 × 100 × 100	50 × 50 × 30	44 × 44 × 30
Travel range $\theta_x, \theta_y, \theta_z$ in °	40 × 40 × 60	20 × 20 × 40	18 × 18 × 25
Load capacity with horizontal mounting in kg	50	50	10
Repeatability in $\mu\text{m}$	up to $\pm 3$	up to $\pm 2$	up to $\pm 1$
Min. incremental motion in $\mu\text{m}$	0.5	0.5	0.5
Max. velocity in mm/s	2	1	3

# Precision Hexapods

For Loads from 50 kg to 250 kg

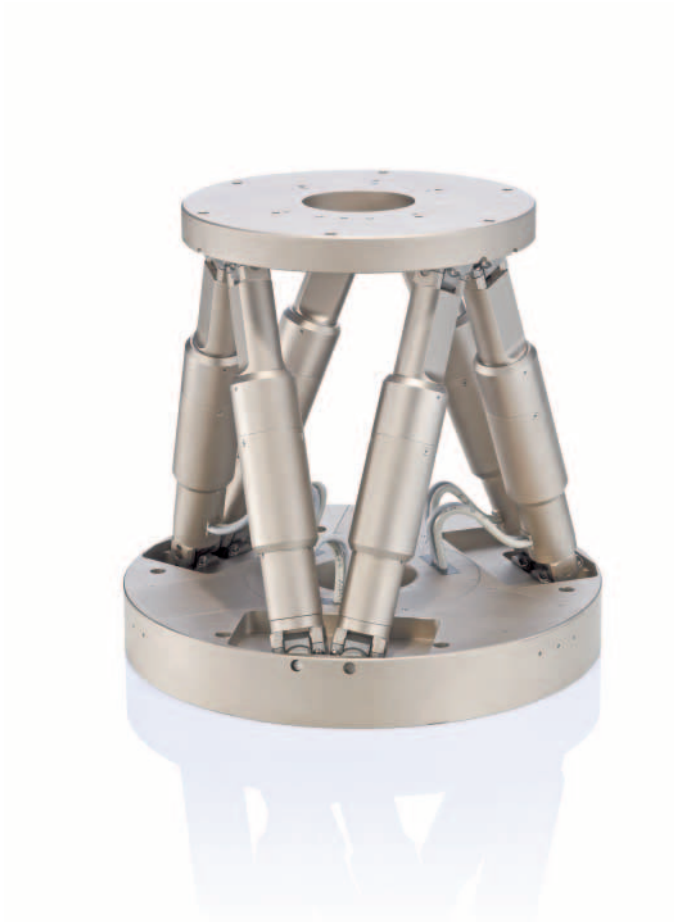

H-850

## Highlights

- Six-axis positioning system with excellent precision
- System with powerful controller with vector algorithms, virtual pivot point
- Comprehensive software package
- Optional interface for PLC control

## Applications

Positioning mirrors in large telescope arrangements is a frequent application of 6-axis positioning systems. Inspection systems, e.g. for large LCD screens, have similar requirements with regard to precision.



M-850KWAH

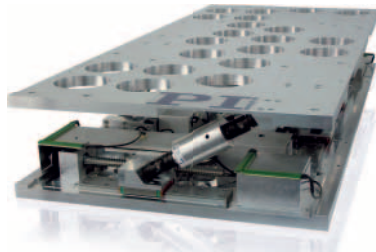

M-850KPAH

## H-850

## M-850K WAH

## M-850K PAH

	High-precision, vacuum-compatible versions up to $10^{-6}$ hPa	Customized model for positioning the secondary mirror in large telescope arrangements	Customized model for positioning patients in medical technology
Dimensions in mm	Ø 350 × 330	Ø 580 × 360	1200 × 530 × 184
Clear aperture in mm	Ø 80	Ø 420	–
Travel range X, Y, Z in mm	100 × 100 × 50	20 × 22 × 32	100 × 100 × 50
Travel range $\theta_x, \theta_y, \theta_z$ in °	±15	±3	±5
Load capacity with horizontal mounting in kg	50 to 250 20 to 50 with any mounting orientation	75	200
Repeatability in $\mu\text{m}$	±0.2 to ±1	±5	±100
Min. incremental motion in $\mu\text{m}$	0.5 to 1	2	100
Typ. velocity in mm/s	0.3 to 5	5	16

# Precision Hexapods

For High Loads of More than 1 Ton

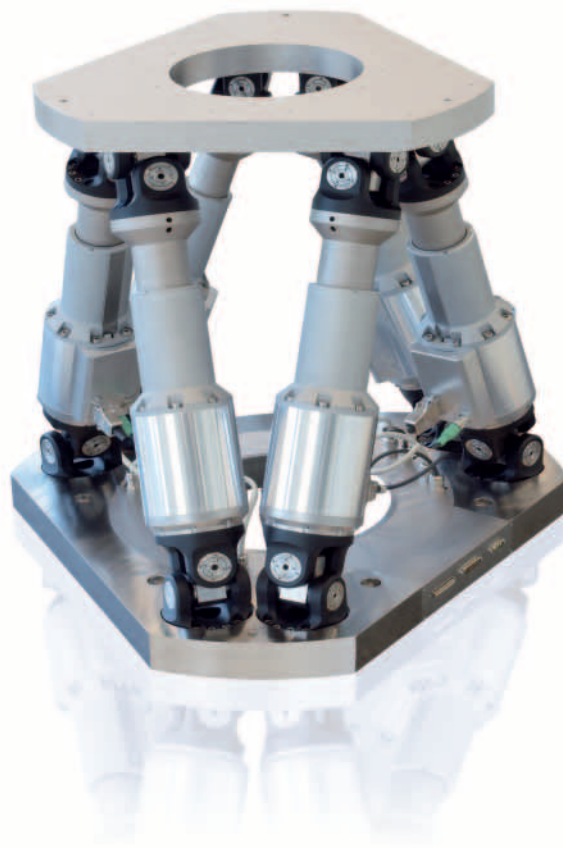

H-845

## Highlights

- Six-axis positioning system with excellent precision
- System with powerful controller with vector algorithms, virtual pivot point
- Comprehensive software package
- Optional interface for PLC control

## Applications

Astronomy and other fields of research, but also industrial production and testing facilities, use parallel kinematics to position in 6 axes with a space-saving system. The mechanical coupling is always adapted to customer-specific requirements.





M-850KHTH

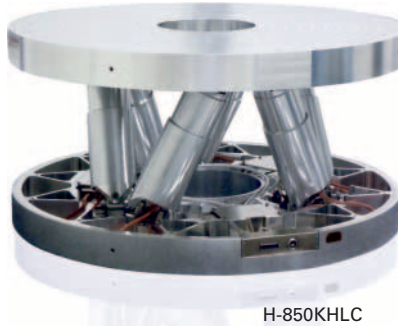

H-850KHLC



M-850KHLH

H-845.  
D11

M-850K  
HTH

H-850K  
HLC

M-850K  
HLH

	Load capacity of up to 400 kg in any orientation	Customized model for a load of 1 ton	Customized model for a load of 1.5 tons, even in any mounting orientation	Customized model for vacuum up to 10 <sup>-6</sup> hPa
Dimensions in mm	Ø 790 × 660	Ø 900 × 710	Ø 1200 × 600	Ø 1000 × 500
Travel ranges X, Y, Z in mm	220 × 220 × 100	400 × 400 × 200	340 × 340 × 220	24 × 24 × 24
Travel range $\theta_x, \theta_y, \theta_z$ in °	40 × 40 × 60	40 × 40 × 10	40 × 40 × 60	6 × 6 × 8
Load capacity in kg	1000	1000	1500	1000
Repeatability in $\mu\text{m}$	±2	±1	±1	±2
Min. incremental motion in $\mu\text{m}$	2	1	1	2
Typ. velocity in mm/s	20	1	0.3	0.1
Motor type	brushless DC motors with integrated brakes	brushless motors with integrated brakes	brushless DC motors with gearhead	brushless DC motors with gearhead, integrated brakes

# Nanometer-Precision Parallel Kinematics

Driven by Piezomotors

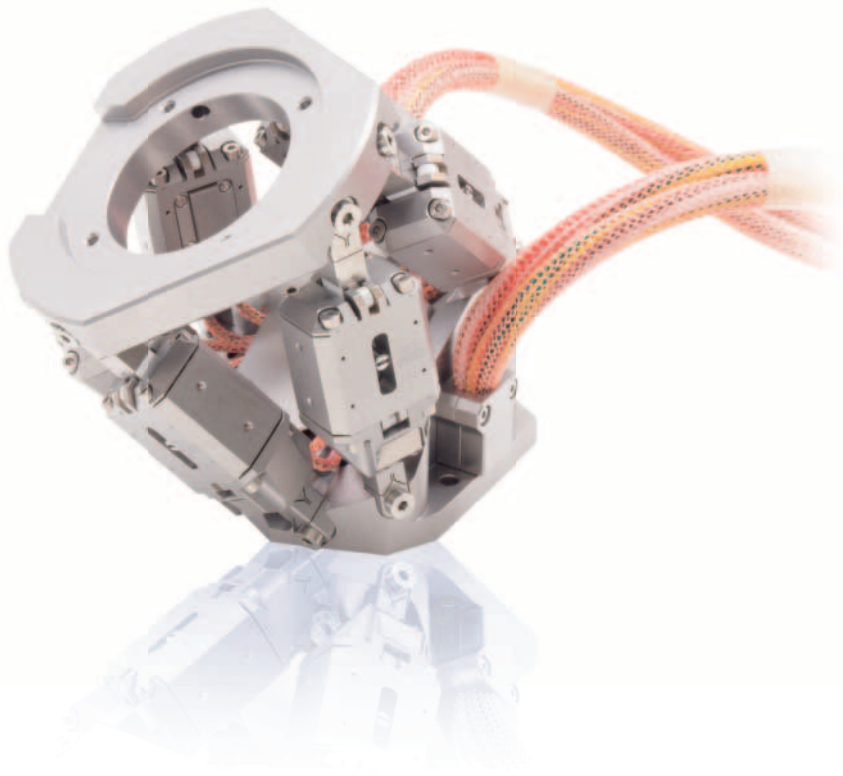

P-911KNMV

## Highlights

- Customized models for applications with very high precision requirements
- Non-magnetic drives
- System with powerful digital controller and integrated drivers for piezo stepping drives

## Applications

Semiconductor inspection, in particular, requires high-precision multi-axis positioners with high stiffness. Parallel kinematics with PiezoWalk® piezo stepping drives guarantee accuracies down to nanometers, which is required for aligning wafers.



N-515KNPH



N-510

P-911K  
NMV

N-515K  
NPH

N-510

	Customized model. UHV-compatible to 10 <sup>-9</sup> hPa, UV-resistant	Customized model with excellent resolution	Powerful Z / tip/tilt platform
Dimensions in mm	Ø 100 × 90	Ø 380 × 140 Aperture Ø 202	Ø 300 × 60 Aperture Ø 250
Travel ranges X, Y, Z in mm	1.5	10	Z: 1.3
Travel range $\theta_x, \theta_y, \theta_z$ in °	2	6	$\theta_x, \theta_y$ : 0.6
Load capacity in kg	5	50	20
Design resolution in nm	100	5	5
Motor type	PiezoWalk® piezo stepping drive	PiezoWalk® piezo stepping drive	PiezoWalk® piezo stepping drive

# Controller for Hexapod Positioning Systems

6-D Vector Motion Control, Comprehensive Functions



C-887.11

## Highlights

- Powerful controller with vector algorithms
- Virtual pivot point, freely programmable
- Data recorder
- Macro programming
- Stand-alone operation possible or control with TCP/IP and RS-232
- Extensive software package
- Included in the delivery of all PI standard Hexapod systems



C-887.21



Customized model for PiezoWalk® piezo stepping drives

## Digital Controller for 6-Axis Parallel Kinematics

Versions	<p>C-887.11 19" controller, comprises the control for two additional single axes with servo motors, the functionality can be enhanced with many additional options</p> <p>C-887.21 compact bench-top controller for a lower system price</p>
Functions	<p>Position control using Cartesian coordinates, vectorized motion. Stable, virtual pivot point can be defined freely in the work space. Real-time data recorder for recording operating parameters such as motor control, velocity, position or position error. Macro command language. Stand-alone operation possible with Autostart macro or connection of keyboard and monitor. Optional: Manual control unit</p>
Interfaces	<p>TCP/IP Ethernet, can also be used for remote control and service. RS-232 for up to 25 m cable length. Standard monitor and keyboard interface.</p> <p>Optional: Analog input. Interface for PLC control. On request: RS-422 for up to 1.4 km cable length. GPIB with measurement equipment</p>
Software	<p>PIMikroMove® user software. Common command set for all PI positioning systems (GCS).</p> <p>Shared libraries for Windows and Linux. Complete set of LabVIEW virtual instruments. Graphical user interfaces (GUI), configuration software and graphically displayed scan routine.</p> <p>Optional: PIVeriMove software for checking a restricted operating space</p>
Custom designs	<p>For use at high altitudes, e.g. for astronomical telescope applications. Processing of absolute position sensors. Control of motor brakes. Processing of additional (redundant) position sensors for increased safety requirements, e.g. in medical technology</p>

# Accessories

## For Hexapod Systems



### C-887.MC

**Control unit for Hexapods, USB connection, 3 m cable**

- Manual operation
- Free step size definition
- Display for position values



### F-206.NCU

**Fast 3-axis piezo nanopositioning system for use in combination with Hexapod systems**

- Consists of P-611.3SF NanoCube<sup>®</sup> XYZ nanopositioning system with SGS sensors, 100 x 100 x 100  $\mu\text{m}^3$ , integrated fiber holder and E-760.3S0 NanoCube<sup>®</sup> piezo controller card, ISA bus

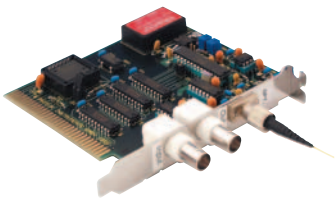

### F-206.VVU

**2-channel photometer card, visible range**

- Optical inputs for 480 to 1040 nm
- Analog inputs 0–10 V

### F-206.iiU

**2-channel photometer card, IR range**

- Optical inputs for 850 to 1680 nm
- Analog inputs 0–10 V



**C-887.A20**  
Hexapod cable set, 20 m

- With 2 signal amplifier boxes for differential data transfer



**F-206.TMU**  
Additional mounting platform  
for H-206 Hexapods

- For fast replacement of different assemblies
- Magnetic coupling

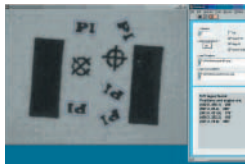

**F-311.LV**  
PIMotion&Vision LabVIEW driver set  
for intelligent automation processes

- Multi-channel image processing for 3D examination or various resolutions
- Functions such as autofocus, edge alignment, distance measurements and complex 6D alignment routines

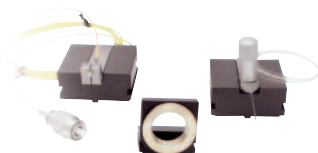

**F-603**  
Fiber, objective and waveguide holders  
for H-206 and P-611 NanoCube®

- Quick fasteners for easy set-up
- Precision-machined, made of high-strength aluminum/brass

# Technology of Parallel-Kinematic Precision Positioning Systems

---

---

## **Six Axes of Motion with Hexapods and SpaceFAB**

**Page 181**

Compact Positioning System – Advantages over Serial Kinematics Design – Components – Work Space

---

## **Hexapods in Automation**

**Page 184**

Precise Trajectory Control Using G-Code – User-Defined Coordinate Systems – Standardized Automation Interfaces

---

## **Motion Control Software from PI**

**Page 186**

Universal Command Set – PIMikroMove Host Software for Fast Start-Up – Fast Integration of PI Controllers in Third-Party Programming Languages and Software Environments

---

## **Hexapod-Specific Software**

**Page 189**

Determining the Work Space – Checking the Permissible Load – PIVeriMove: Preventing Collisions with Restricted Work Space – Emulation: The Hexapod System as a Virtual Machine – HexaApp: PI Hexapod Control via iPhone, iPad or iPod

---



# Parallel-Kinematic Precision Positioning Systems

## Six Axes of Motion with Hexapods and SpaceFAB

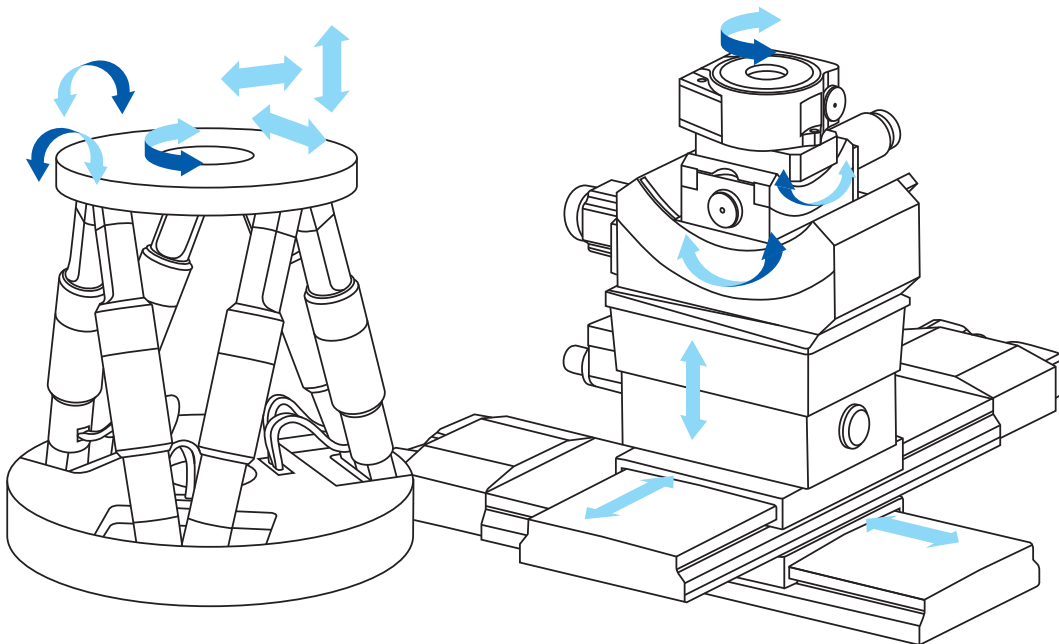

### Compact Positioning System with Six Degrees of Freedom

Hexapod platforms are used for moving and precision positioning, aligning and displacing loads in all six degrees of freedom, i.e. three linear and three rotational axes.

Hexapods have a parallel-kinematic structure, i.e. the six drives act together on a single moving platform. The length of the single drives can be changed so that the system moves in all six degrees of freedom in space. This special Hexapod design optimizes the overall system stiffness and allows for a large central aperture.

### Precise Positioning Even of Heavy Loads

Depending on their design, Hexapods can position loads from several kg up to several tons in any spatial orientation, in other words independently of the mounting orientation and with submicrometer precision.

### Advantages over Serial-Kinematic Design

Hexapods can be designed considerably more compact than serially stacked multi-axis positioning systems. Since only a single platform, most often provided with a large aperture, is actuated, the moving mass of the Hexapod is significantly smaller. This results in improved dynamics with considerably faster response. Furthermore, cabling is no issue, so that no additional forces and torques reduce the accuracy.

In case of stacked systems, the lower axes not only move the mass of the payload but also the mass all other following drives. This reduces the dynamic properties and the total system stiffness. Moreover, the runouts of the individual axes add up to a lower accuracy and repeatability.



Cardanic joints of the H-840 Hexapod model



Ball-and-socket joints

### Matching Components for High Precision

The basis is a zero-backlash structure and carefully selected and matching components. This includes first of all the right material selection, when e.g. thermal effects are to be expected at the place of operation. The motor, if necessary with gearhead, an integrated guiding, the leadscrew/nut unit, as well as the joints for the required load range up to high-resolution position detection in every strut – all these elements determine the achievable precision.

### Motors and Drives

PI Hexapods are based on electromechanical drives and are much more accurate than the hydraulic Hexapods known from flight or driving simulators. Precision leadscrew drives or piezo linear motors are used. Most systems are self-locking. Direct-drive Hexapods ensure higher velocities; for industrial use, brushless motors (BLDC) are particularly suitable.

The application determines the drive technologies: Hexapods with piezoelectric PiezoWalk® stepping drives are suitable for ultrahigh vacuum applications and can also be operated in very strong magnetic fields.

### Joints

Hexapods for precision positioning often have Cardanic joints with two orthogonally arranged axes. This is the optimum combination of two degrees of freedom and the stiffness of the structure.

Ball-and-socket joints offer more degrees of freedom in a relatively simple design. However, the overall stiffness and precision in case of external loads and torque can suffer. A compensating preload is recommended but requires drives with high output forces such as the NEXLINE® piezomotor drives.

If the highest precision and few linear bending displacements and angles are required, flexure joints are recommended. They exhibit neither friction nor backlash and do not require lubricants.

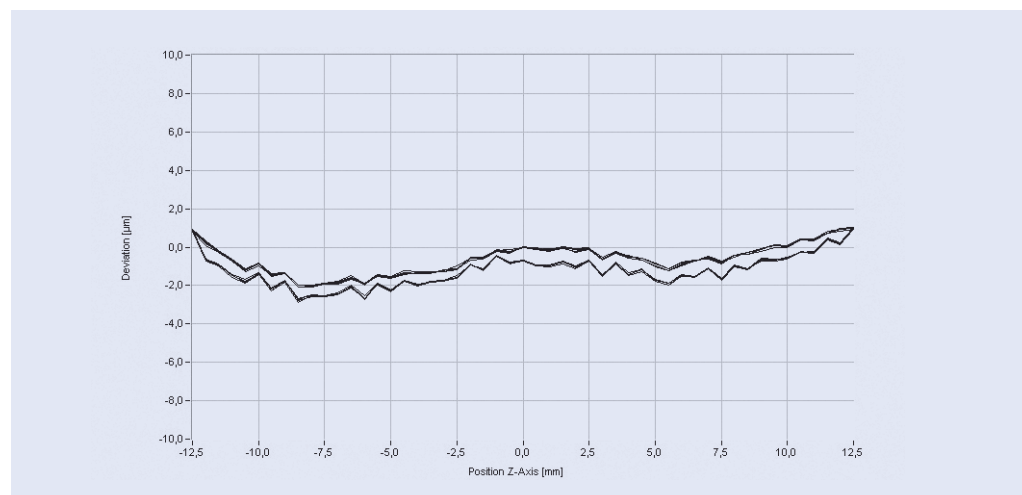

The positioning accuracy of a precision H-824 Hexapod in Z direction over the complete travel range of 25 mm is a few micrometers, and the repeatability is considerably below  $\pm 0.1 \mu\text{m}$

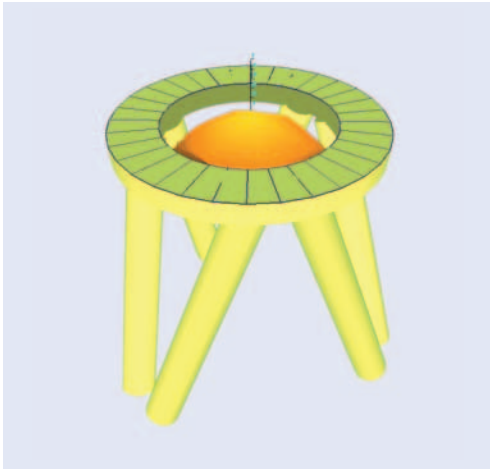

### The Work or Motion Space

Due to actuator travel and joint angles, the Hexapod platform can carry out any combination of tilting and rotation around a freely selectable pivot point in addition to the linear motion. The cables do not produce friction nor limit the work space in contrast to a serial arrangement with cabling for each individual axis.

### Hexapods with Passive Struts

Instead of variable, active struts, Hexapods can be designed with passive struts that show constant strut length. In this case the coupling points or joints are usually moved along a linear path. This design is advantageous when the drive unit is to be separated from the platform, e.g. outside of cleanrooms or vacuum chambers.

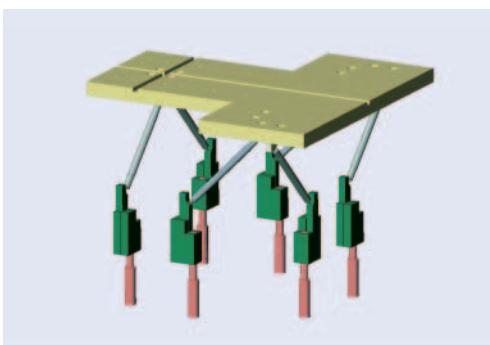

Constant strut-length Hexapod design. The drive units move the joint position up and down affecting the linear and rotary position of the platform

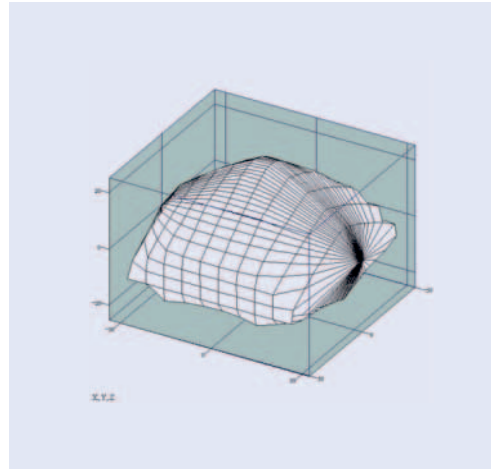

The entirety of all combinations of translations and rotations that a Hexapod can approach from any given position is called the work space; it is given in reference to the origin of the coordinate system used. The work space can be limited by external factors such as obstacles or the position and size of the load

### Advanced Motion Control

The individual drives of a Hexapod do not necessarily point in the direction of motion, which is why a powerful controller that can handle the required coordinate transformations in real time is needed.

PI uses advanced digital controllers along with user-friendly software. All motion commands are specified in Cartesian coordinates, and all transformations to the individual actuators take place inside the controller.

An important Hexapod property is the freely definable pivot point. The possibility to rotate around any point in space opens up new application possibilities, and the Hexapod platform can be integrated in the overall process.



In this 3-strut design, additional degrees of freedom are produced because a passive strut can be moved in two or more axes. Example: In SpaceFAB, the individual struts are driven by one XY translation stage each

# Hexapods in Automation

## Control and Interfaces for Easy Integration

### Precise Trajectory Control Using G-Code

The Hexapod controller may also control the trajectory based on G-Code according to DIN 66025/ISO 6983. The G-Code command language is directly implemented in the controller.

With G-Code, moving along complex trajectories with defined velocity and acceleration is possible. The Hexapod system can, for example, move a workpiece or tool jerk-controlled and with high precision during machining without the mechanical system starting to vibrate.

### User-Defined Coordinate Systems

To adapt the trajectory perfectly to the requirements of the application, it is possible to define various coordinate systems which refer, for example, to the position of workpiece or tool. This offers great advantages for applications in industrial automation, but also for fiber alignment.

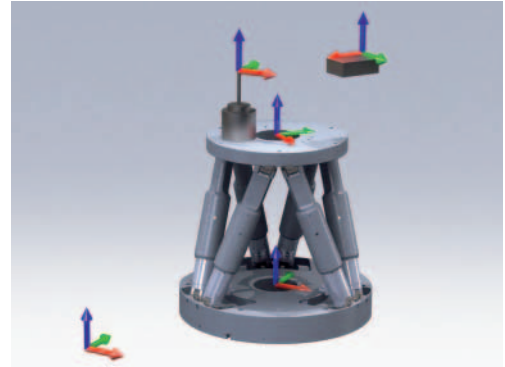

Any coordinate system used as a reference for target values of the Hexapod may be defined

### Standardized Automation Interfaces

Standardized fieldbus interfaces guarantee an easy connection to parent PLC or CNC controls so that Hexapods can work synchronously with other components in one automation line.

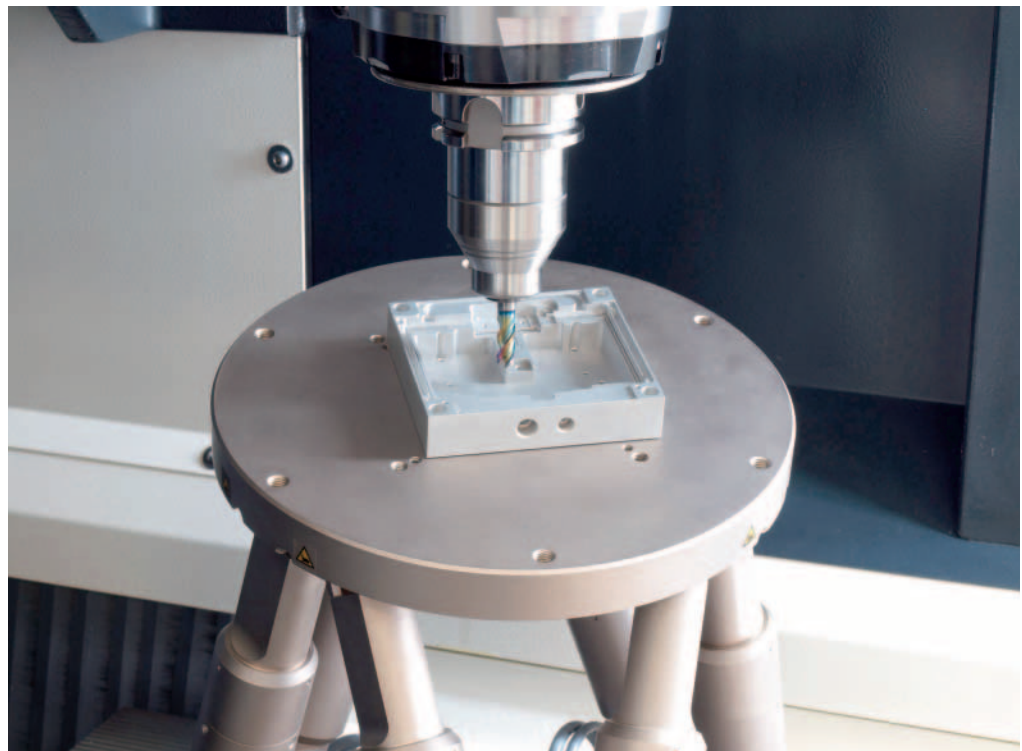

Standardized fieldbus interfaces make integration easier: Hexapods in automation technology

The PLC acts as master and defines the target position in Cartesian coordinates and the trajectories; in return, it gets the actual positions also over the fieldbus interface. All other calculations required to command the parallel-kinematic six-axis system are done by the Hexapod controller, i.e. transforming the nominal positions from Cartesian coordinates into drive commands for the individual drives. In this case, the controller acts just like an intelligent drive.

The cycle times for determining new positions, evaluating signals and synchronizing are between 1 and 3 ms. Fieldbus interfaces are currently available for Profibus, EtherCAT, Profinet, CANopen and SERCOS.

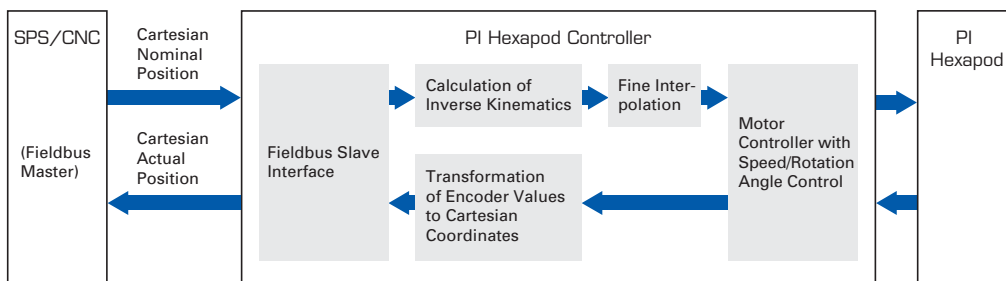

Block diagram: The Hexapod controller acts just like an intelligent drive. The fieldbus interface can be exchanged to allow communication with numerous types of PLC or CNC control

# Motion Control Software

Effective and Comfortable Solutions

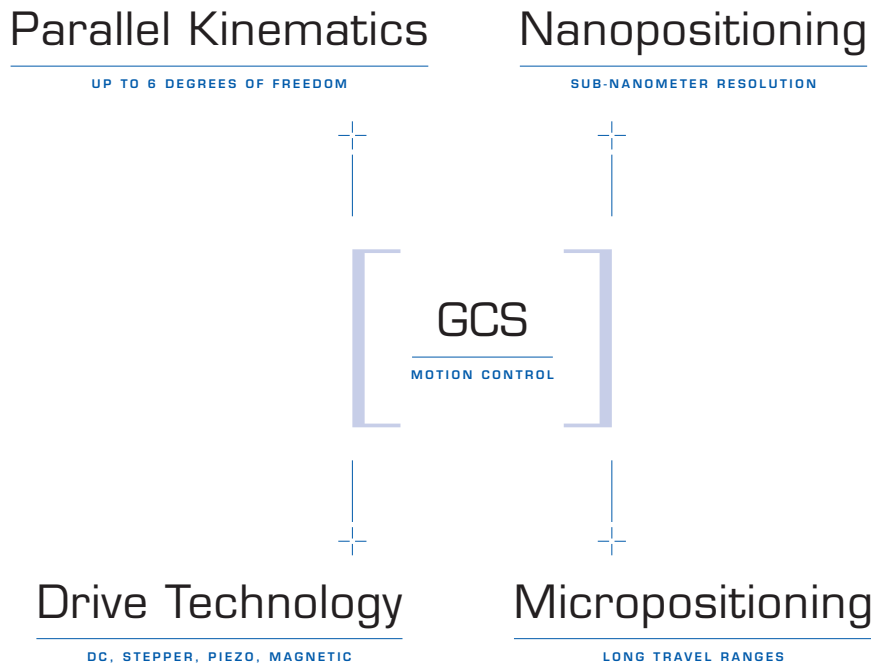

## Supported Operating Systems

- Windows XP (SP3)
- Windows VISTA
- Windows 7 32/64 bit
- Linux 32/64 bit
- Windows 8 32/64 bit

All digital controllers made by PI are accompanied by a comprehensive software package. PI supports users as well as programmers with detailed online help and manuals which ease initiation of the inexperienced but still answer the detailed questions of the professional. Updated software and drivers are always available to PI customers free of charge via the Internet.

PI software covers all aspects of the application from the easy start-up to convenient system operation via a graphical interface and quick and comprehensive integration in customer written application programs.

## Universal Command Set Simplifies Commissioning and Programming

PI's General Command Set (GCS) structure is consistent for all controllers regardless of their complexity and purpose. GCS with its many preprogrammed functions accelerates the orientation phase and the application development process significantly while reducing the chance of errors, because the commands for all supported devices are identical in syntax and function. Further advantages are that different PI controllers can be added and integrated more easily and system upgrades can be introduced with a minimum of programming effort.

## PIMikroMove Software Ensures Rapid Start-Up

PIMikroMove is PI's convenient graphical user interface for any type of digital controller and positioning system, regardless of whether piezoelectric, linear motors, or classical electrical motor drives are used and independent of the configuration and number of axes.

All connected controllers and axes are displayed and controlled consistently with the same graphical interface. Two or more independent axes can be moved in the position pad using the mouse or a joystick, including vectorially; Hexapods are displayed graphically.

Macro programs simplify repetitive tasks for example in automated processes. The macros are created as GCS command sets that can be executed directly on the controller, e.g. as a start-up macro that allows stand-alone operation; they can also be processed by the host PC.

Scan algorithms can record analog values as a function of position or find the global maximum of an analog value fully automatically.

Depending on the specific controller, PIMikroMove supports a number of additional functions. A data recorder can record system parameters and other variables during motion for later analysis.

## Optimizing System Behavior

When the mechanical properties of a positioning system are changed, e.g., by applying a different load, motion control parameters often need to be adapted. PI software provides tools for optimization of the system response and stability. Different parameter sets can be saved for later recall, also accessible from custom application programs.

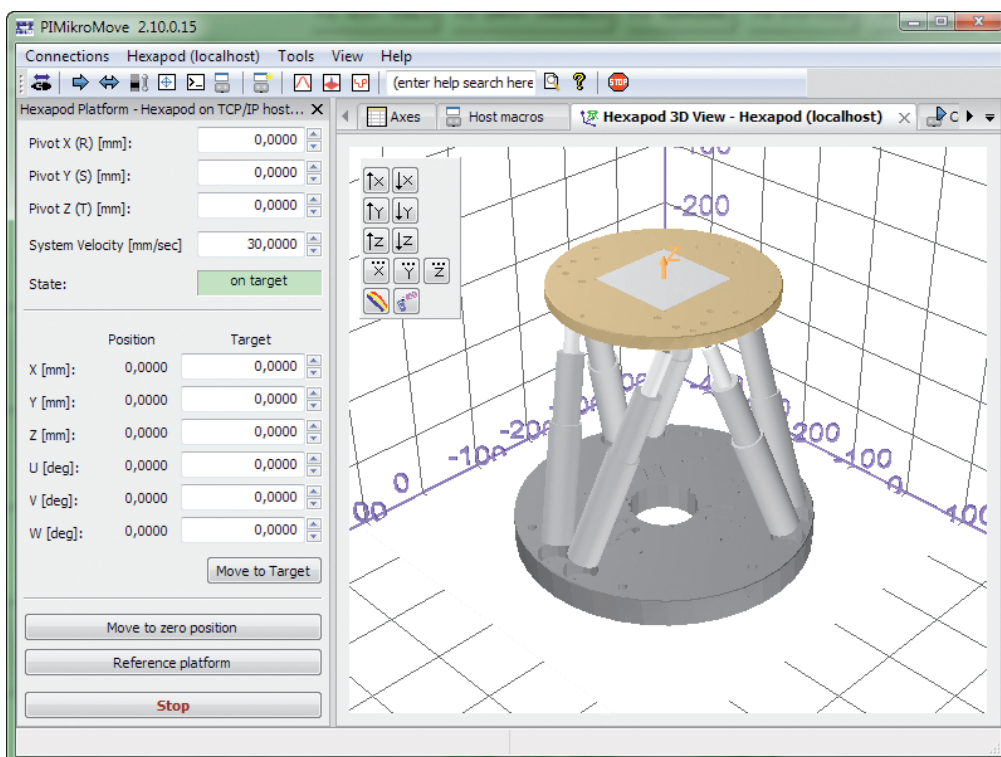





## Hexapod-Specific Software

Due to their parallel kinematic structure, Hexapods necessitate a particularly complex control system. The position coordinates, for example, are given in virtual Cartesian axes which are then converted into positioning commands for the individual actuators by the controller. PI supplies special software that allow the 6-axes positioners to be more convenient in operation and easier to integrate.

### Determining the Work Space

The limits of the work space vary depending on the current position of the Hexapod (translation and rotation coordinates) and the current coordinates of the pivot point. A special software tool included with each PI Hexapod calculates these limits and displays them graphically.

### Checking the Permissible Load

As with any multi-axis positioning system, the load limit of the Hexapod varies as a function of a number of factors such as orientation of the Hexapod, size and position of the payload, current position (translation and rotation coordinates) of the Hexapod platform, and forces and moments acting on the platform.

The Hexapod software package includes a PI simulation tool that calculates all forces and moments and compares them individually against the specified load limits of the corresponding Hexapod mechanics.

### PIVeriMove: Preventing Collisions with Restricted Work Space

Another proprietary PI simulation software tool enables offline graphical configuration and simulation of the Hexapod motion in the application environment. CAD data of objects can be imported or approximated with simple shapes such as cylinders and cuboids. PIVeriMove then checks restrictions in the work space. Implemented in the controller firmware or the application software, this prevents the Hexapod from approaching positions where the platform, struts, or the mounted load would collide with the surroundings.

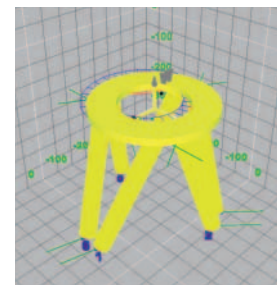

The simulation software graphically displays the position and the available work space of the Hexapod model

### Emulation: The Hexapod System as a Virtual Machine

A virtual machine that can be installed on the customer's host PC is available to emulate a complete Hexapod systems (mechanics, controller and even peripherals). PI supplies a suitable software that can be used to realize a complete hexapod system (hexapod mechanics and controller, possibly including peripherals) as a virtual machine on the host-PC. Application programs can then be developed and pre-tested, different load scenarios can be simulated and the work space can be determined before the system arrives, saving significant cost and development time. And everything is ready for use at the time of delivery!

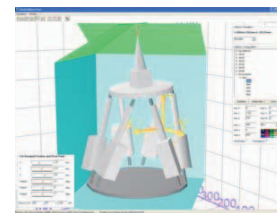

### HexaApp: PI Hexapod Control via iPhone, iPad or iPod

The Hexapod system can also be controlled wirelessly from mobile Apple iOS devices. A corresponding app enables command control of touchscreen, motion sensors or via a command input window.

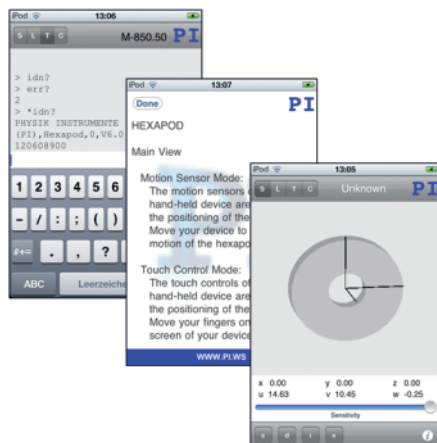



# Motorized Positioning Systems

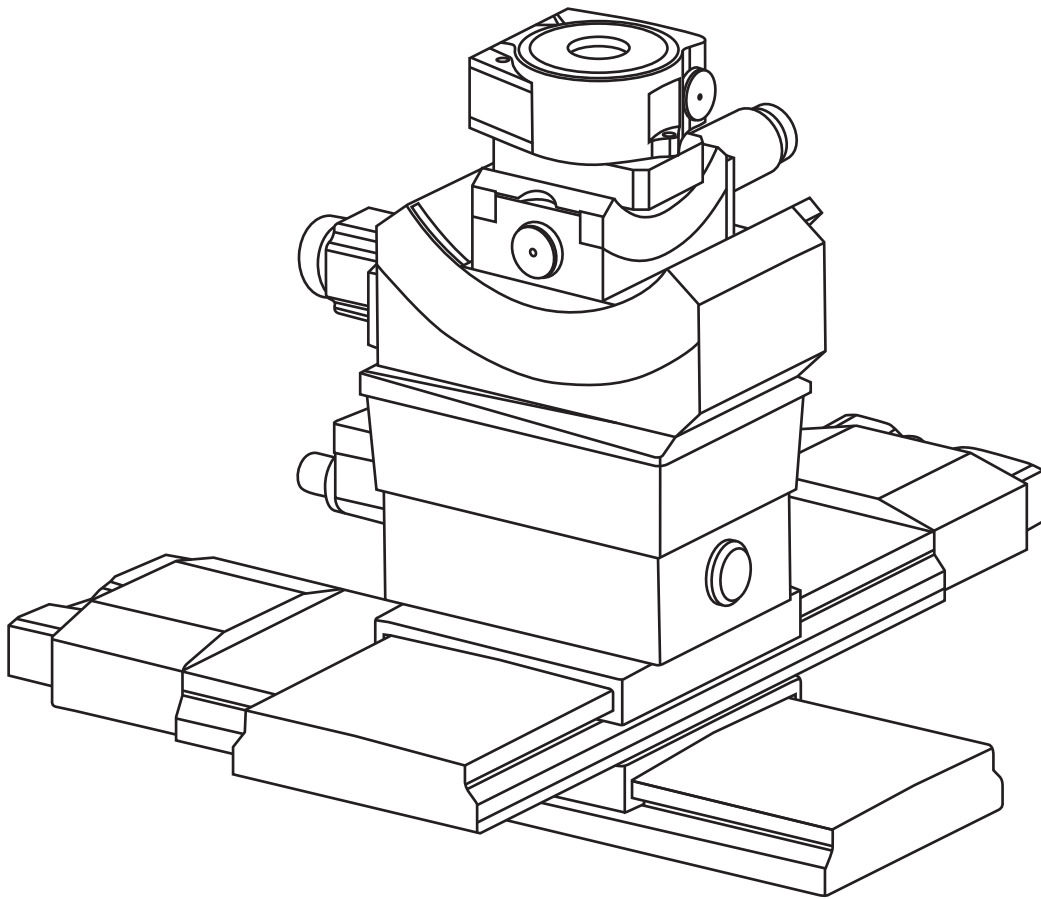

---

**Products**

**Page 192–251**

---

**Basics of Motorized Positioning Systems**

**Page 252–265**

---

# Precision Linear Positioning Stages

---



System with high-precision PI miCos linear and rotational axes for the positioning of wafers in chip production

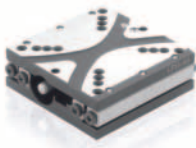

**Linear Positioning Stages with Piezomotors**

**Page 194**



**Small Precision Linear Positioning Stages**

**Page 198**



**Linear Positioning Stages for Travel Ranges up to 1 m**

**Page 202**

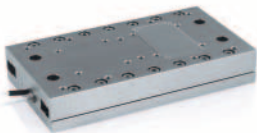

**Nanometer Precision over Long Travel Ranges**  
Fast Scans at Constant Velocity

**Page 208**



**High-Speed Stages of Excellent Precision**  
Electromagnetic Linear Motor Combined with High-Resolution Encoder

**Page 210**

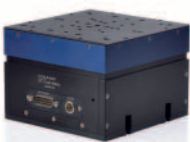

**Precision Z Stages**

**Page 212**

# Miniature Stages with Piezomotors and Direct Position Measurement

Piezomotors Replace Electric Motor-Spindle Drives in Miniature Positioning Stages

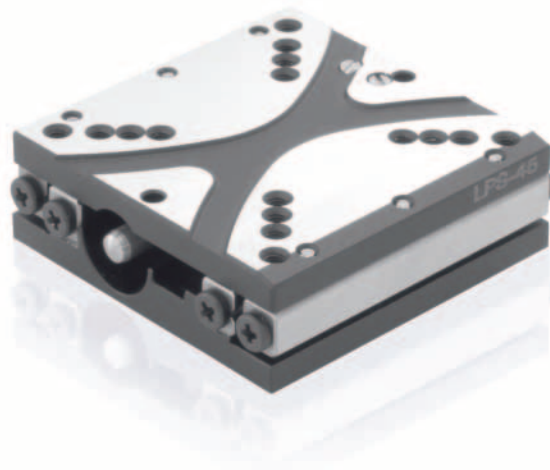

LPS-45

## Highlights

- Linear encoder with resolution down to a few nanometers
- Very compact XY combinations
- Vacuum versions up to  $10^{-9}$  hPa available
- Nonmagnetic designs available on request

## Applications

Piezoelectric linear motors allow production of stages with smallest dimensions. The direct drive avoids mechanical components such as gears and spindles, making for reliable and high-resolution drives down to a few nanometers. Piezomotors are in general vacuum-compatible and do not generate any magnetic interferences. Accordingly, they open up areas of application in which electric motors cannot be used. In combination with a directly measuring optical encoder, for example stages with PIShift inertia drives allow high-precision and repeatable positioning. Depending on the drive principle, high velocity, high forces and/or high resolution are achieved.



LPS-23



LPS-24

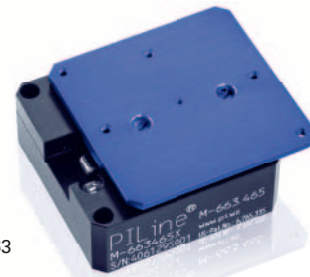

M-663

## LPS-23

## LPS-24

## M-663

## LPS-45

	Smallest closed-loop positioning system	Best force/installation space ratio	High-speed linear motor of up to 250 mm/s	High guiding accuracy
Travel range in mm	13, 26	15	19	13, 26
Dimensions in mm	23 to 35 × 23 × 10	33 to 60 × 24 × 20	35 × 35 × 15	48 to 63 × 45 × 15
Design resolution in $\mu\text{m}$	0.001	0.002	0.1, 0.6	0.001
Min. incremental motion in $\mu\text{m}$	0.01	sensor-dependent 0.3 to 0.04	sensor-dependent 0.3 to 3	0.006
Unidirectional repeatability in $\mu\text{m}$	0.02	sensor-dependent 0.3 to <0.01	sensor-dependent 0.3 to 0.2	0.018
Angular crosstalk (pitch / yaw) in $\mu\text{rad}$	$\pm 80$ to $\pm 110$	$\pm 100$	$\pm 300$	$\pm 50$ , $\pm 80$
Velocity in mm/s	10	10	250	10
Load capacity in N	2	10	5	10
Push / pull force in N	2	5	2	8
Holding force in N	2	7	2	8
Motor type	PIShift piezo inertia drive	NEXACT® piezo stepping drive	PILine® ultrasonic piezomotor	PIShift piezo inertia drive
Operating voltage peak-to-peak in V	48	55	120	48
Recommended controller	E-871 single-axis	E-861 single-axis	C-867 single- or double-axis	E-871 single-axis

# Linear Positioning Stages with Piezomotors and Direct Position Measurement

Piezo Direct Drive Allows Very Low Profile



LPS-65

## Highlights

- Direct position measurement with high-resolution optical encoder
- Self-locking when at rest, no heat generation
- Very compact XY combinations
- Vacuum versions available

## Applications

Test equipment for industrial production or quality assurance benefits from the low space requirement of the piezomotors. The large dynamic range of PLine® ultrasonic drives makes them suitable for life science applications or research institutions in biotechnology, where quick switchover from scanning mode to precise positioning is required.



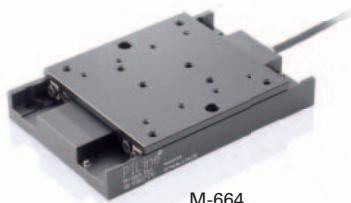

M-664



M-683



M-664K

## LPS-65

## M-664

## M-683

## M-664K

	LPS-65	M-664	M-683	M-664K
				Customized model
Travel range in mm	13, 26, 52	25	50	50
Dimensions in mm	80 to 160 × 65 × 20	90 × 50 × 16	130 × 95 × 21	120 × 40 × 9
Design resolution in $\mu\text{m}$	0.0005	0.1	0.02	0.5
Min. incremental motion in $\mu\text{m}$	0.001	0.6	0.1	3
Unidirectional repeatability in $\mu\text{m}$	0.001	0.2	0.1	1
Angular crosstalk (pitch / yaw) in $\mu\text{rad}$	$\pm 40$ to $\pm 60$	$\pm 75 / \pm 50$	$\pm 150 / \pm 50$	$\pm 150$
Velocity in mm/s	10	400	350	100
Load capacity in N	20	25	50	–
Push / pull force in N	10	2.5	6	2
Holding force in N	10	2.5	6	2
Motor type	NEXACT® piezo stepping drive	PILine® ultrasonic piezomotor	PILine® ultrasonic piezomotor	PILine® ultrasonic piezomotor
Operating voltage peak-to-peak in V	55	200	200	200
Recommended controller	E-861 single-axis	C-867 single- or double-axis	C-867 single- or double-axis	C-867 OEM version, networkable

# Small Precision Micropositioning Stages Equipped with Electric Motors

Travel Ranges of up to 52 mm (2"), Loads of up to 50 N

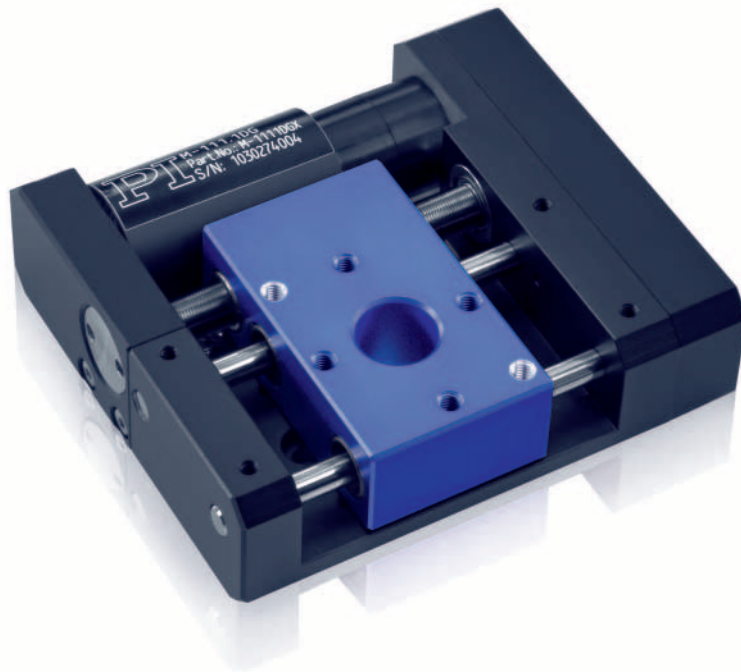

M-110

## Highlights

- For loads of up to 5 kg
- Very compact XY and XYZ combinations
- Travel ranges of up to 52 mm (2")

## Applications

Compact drive solutions are indispensable for automated sequences in many areas ranging from micro-processing in precision mechanical engineering to photonics production. These small positioning stage series are highly suitable both for test systems and for use in the production process. Different motorizations, positioning accuracy and travel ranges offer a wide range of possible fields of application.

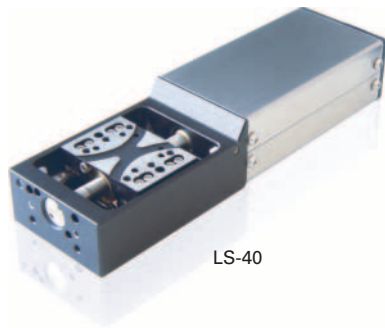

LS-40



M-122

## LS-40

## M-110 M-111 M-112

## M-122

Travel range in mm	13, 26, 52	5 to 25	25
Dimensions in mm	62.5 to 101.5 × 40 × 20 plus motor 77 × 40 × 26	60 to 80 × 62 × 20.5	86 × 60 × 20.5
Design resolution in $\mu\text{m}$	to 0.01	to 0.007	0.1
Min. incremental motion in $\mu\text{m}$	0.1	0.05 to 0.2	0.2
Unidirectional repeatability in $\mu\text{m}$	0.1	0.1 to 0.5	0.15
Angular crosstalk (pitch / yaw) in $\mu\text{rad}$	$\pm 150$ to $\pm 190$	$\pm 50$ to $\pm 150$	$\pm 150$
Velocity in mm/s	5	1 to 2	20
Drive screw pitch in mm	0.5, 1	0.4, 0.5	0.5
Load capacity in N	30	20 to 30	50
Push / pull force in N	20	10	20
Motor type	DC gear motor / 2-phase stepper motor with and without gearhead	DC gear motor / 2-phase stepper motor	DC motor
Recommended controller	SMC controller	C-863 single-axis C-663 single-axis	C-863 single-axis

Stepper motor resolution controller-dependent

# Compact Precision Linear Positioning Stages Equipped with Electric Motor

Travel Ranges of up to 100 mm, Loads of up to 300 N

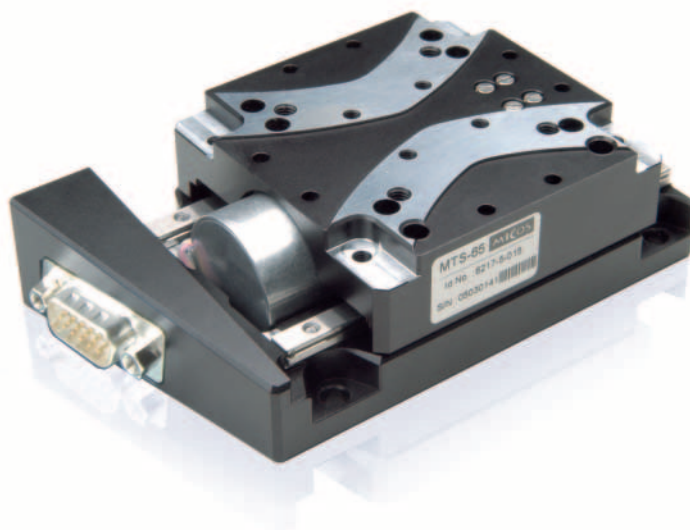

MTS-65

## Highlights

- Large selection of models with different drive screws
- Compact XY combinations
- Large number of motor variants

## Applications

These compact linear positioning stages offer travel ranges of up to 100 mm (4") and can be used over a wide range. Typically they are required for inspection systems with little available space. Their tasks range from micromanipulation, for example of optical components, to high-precision positioning of loads of up to 30 kg in testing and inspection systems.

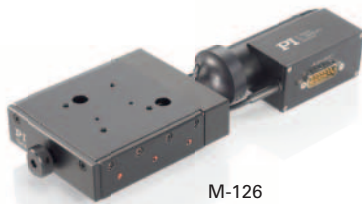

M-126

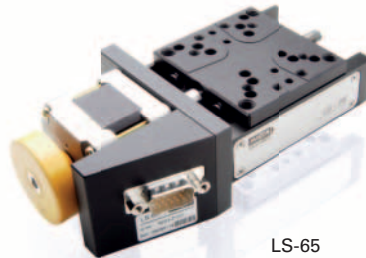

LS-65



M-605

MTS-65

M-126

LS-65

M-605

Travel range in mm	13 to 52	20 to 25	26 to 102	25, 50
Dimensions in mm	38.5 to 62 x 65 x 31	101.5 x 83 x 26 plus motor 115 x 40 x 34	93 to 171 x 65 x 30 plus motor 90 x 40 x 40	194 x 113 x 33.5
Design resolution in $\mu\text{m}$	to 0.05	to 0.0035	to 0.5	0.1
Min. incremental motion in $\mu\text{m}$	to 0.05	0.1 to 1	0.2 to 0.5	0.3
Unidirectional repeatability in $\mu\text{m}$	0.1	0.1 to 0.2	0.3 to 0.5	0.1
Angular crosstalk (pitch / yaw) in $\mu\text{rad}$	$\pm 40$ to $\pm 80$	$\pm 50$	$\pm 70$ to $\pm 130$	$\pm 30$
Velocity in mm/s	8	0.7 to 50	13 to 20	50
Drive screw pitch in mm	1	0.5 to 1	1	1
Load capacity in N	10	200	60	300
Push / pull force in N	3	40/40 to 50/50	25	20
Motor type	2-phase stepper motor	DC gear motor, DC motor with integrated ActiveDrive amplifiers	DC gear motor, 2-phase stepper motor	DC motor with integrated ActiveDrive amplifiers
Recommended controller	SMC controller	C-863 single-axis C-663 single-axis	SMC controller	C-863 single-axis

Stepper motor resolution controller-dependent

# Linear Positioning Stages for Travel Ranges of up to 600 mm and Loads of up to 200 N

## Large Range of Motorization Variants

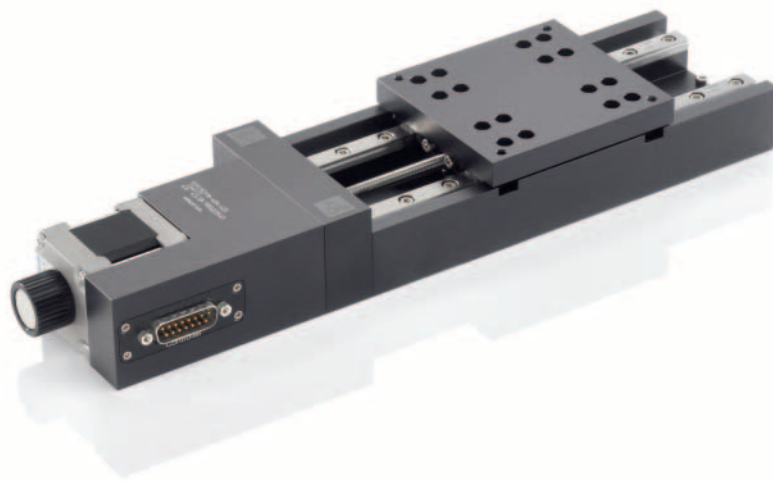

M-404

## Highlights

- Preloaded precision leadscrews or ball screws for high velocity and large number of cycles
- Variable travel ranges from 25 to 600 mm
- XY and XYZ combinations
- For cost-efficient system solutions
- Vacuum versions available

## Applications

Possible applications range from process automation to industrial testing systems and quality assurance tasks. These stage series reliably position medium loads from 50 to 200 N. The large number of variants can be selected to perfectly suit the particular situation.



M-403  
M-404

M-413  
M-414

VT-80

VT-75

Travel range in mm	25 to 200	100 to 300	25 to 300	50 to 600
Dimensions in mm	141 to 316 x 80 x 40.5	255 to 455 x 120 x 57	100 to 375 x 80 x 25 plus motor 70 x 40 x 40	181 to 781 x 75 x 30 plus motor 110 x 43 x 70
Design resolution in $\mu\text{m}$	to 0.012	to 0.018	to 0.5	to 2
Min. incremental motion in $\mu\text{m}$	0.1 to 0.25	0.1 to 0.5	0.2 to 0.5	0.4 to 2
Unidirectional repeatability in $\mu\text{m}$	0.5 to 1	0.5 to 1	0.4 to 0.8	0.4 to 2
Angular crosstalk (pitch / yaw) in $\mu\text{rad}$	$\pm 75$ to $\pm 200$ per 100 mm	$\pm 100$ to $\pm 300$ per 100 mm	$\pm 100$ to $\pm 210$	$\pm 40$ to $\pm 110$
Max. velocity in mm/s	50	100	20	150
Drive screw pitch in mm	1, 2	1, 2	1	4
Load capacity in N	200	500	50	50
Push / pull force in N	50, 100	50, 200	30	18 to 88
Motor type	DC gear motor, DC motor with integrated ActiveDrive amplifiers, 2-phase stepper motor	DC gear motor, DC motor with integrated ActiveDrive amplifiers, 2-phase stepper motor	DC gear motor, 2-phase stepper motor	DC motor, 2-phase stepper motor
Recommended controller	C-863 single-axis C-663 single-axis	C-863 single-axis C-663 single-axis	SMC controller	SMC controller

Stepper motor resolution controller-dependent

# Linear Positioning Stages for Travel Ranges of up to 500 mm

Precision Micropositioning Stages for Loads of up to 1000 N

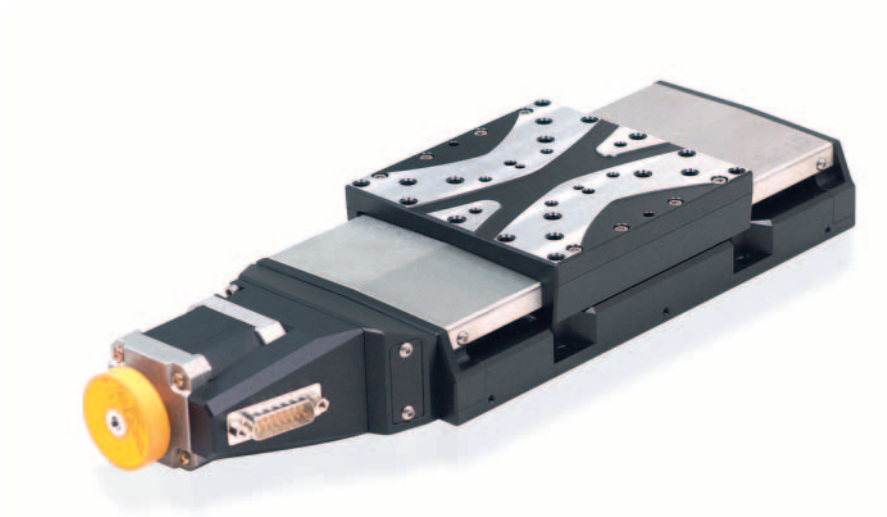

LS-110

## Highlights

- Covered mechanics as dust and dirt protection
- Combinations of different motorizations and variable travel ranges
- High stiffness and mechanical stability

## Applications

Industrial applications in the production process such as laser processing benefit from the precise positioning of these positioning stages. Their low profile makes the variable stage series suitable for universal use, ranging from testing systems to production lines in precision automation.



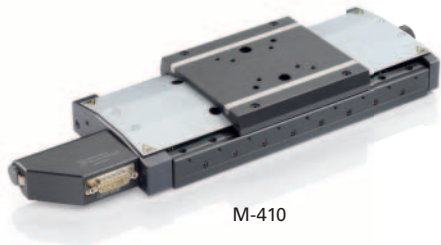

M-410

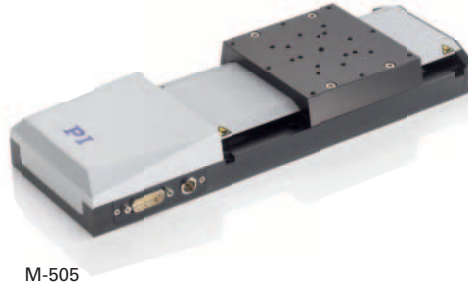

M-505



LS-180

M-405  
M-410  
M-415

M-505

LS-110

LS-180

Dimensions in mm	207 to 307 × 106.5 × 40 plus motor 125 × 60 × 36	245 to 370 × 108 × 43	225 to 480 × 110 × 45	470 to 920 × 180 × 55
Travel range in mm	50 to 150	25 to 150	26 to 305	155 to 508
Design resolution in $\mu\text{m}$	to 0.0035	to 0.017	to 0.05 with linear encoder	to 0.05 with linear encoder
Min. incremental motion in $\mu\text{m}$	0.1 to 0.25	0.05 to 0.25	0.05 to 1	0.05 to 0.5
Unidirectional repeatability in $\mu\text{m}$	0.2	0.1 to 0.25	0.05 to 1	0.05 to 0.5
Angular crosstalk (pitch / yaw) in $\mu\text{rad}$	$\pm 25$ to $\pm 75$	$\pm 25$	$\pm 30$ to $\pm 100$	$\pm 40$ to $\pm 100$
Velocity in mm/s	0.7 to 15	3 to 50	45 to 90	75 to 200
Drive screw pitch in mm	0.5	1	2	5
Load capacity in N	200	1000	100	1000
Push / pull force in N	40 to 50	50	80	200
Motor type	DC gear motor, DC motor with integrated ActiveDrive amplifiers, 2-phase stepper motor	DC gear motor, DC motor with integrated ActiveDrive amplifiers, 2-phase stepper motor	DC motor, 2-phase stepper motor	DC motor, 2-phase stepper motor
Recommended controller	C-863 single-axis C-663 single-axis	C-863 single-axis C-663 single-axis	SMC controller	SMC controller

Stepper motor resolution controller-dependent

# Linear Positioning Stages for Travel Ranges of up to 1 m

High-Precision Positioning with Step Sizes of down to a few 10 nm



M-511

## Highlights

- Reference-class positioning
- Excellent long-term stability through high-stiffness basic profiles
- High-precision components such as crossed roller guides and zero-backlash ball screws
- XY combinations; matching Z stages available
- Optionally direct position measurement with linear encoder

## Applications

The areas of application of these stage series are among the most demanding in precision positioning. They include inspection of wafers in semiconductor technology, alignment and integration of testing devices in photonics production or even measuring and inspection tasks in quality assurance.

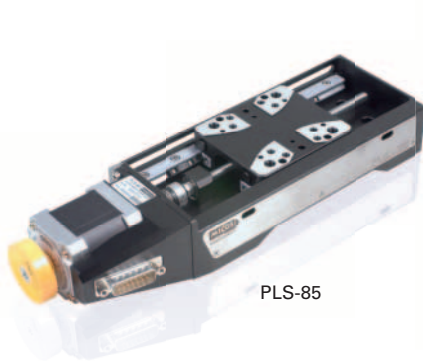

PLS-85



HPS-170

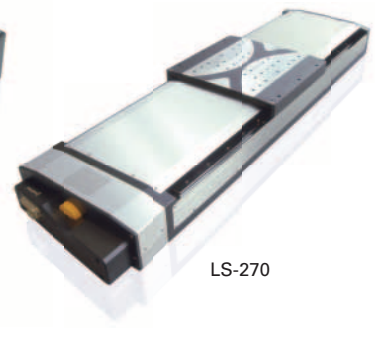

LS-270

## PLS-85

## HPS-170

## M-511 M-521 M-531

## LS-270

Travel range in mm	26 to 155	52 to 305	102 to 306	155 to 1016
Dimensions in mm	119.5 to 257.5 × 85 × 35 plus motor 100 × 43 × 70	261 to 556 × 170 × 50 plus motor 100 × 75 × 50	400 to 600 × 140 × 55	550 to 1400 × 270 × 100
Design resolution in $\mu\text{m}$	0.05	to 0.05	to 0.02	to 0.05
Min. incremental motion in $\mu\text{m}$	0.05 to 1	0.05 to 0.2	0.1 to 0.5	0.05 to 0.5
Unidirectional repeatability in $\mu\text{m}$	0.05 to 1	0.05 to 0.2	$\pm 0.1$ to $\pm 0.5$	0.05 to 0.5
Angular crosstalk (pitch / yaw) in $\mu\text{rad}$	$\pm 60$ to $\pm 150$	$\pm 20$ to $\pm 40$	$\pm 25$ to $\pm 50$	$\pm 20$ to $\pm 120$
Velocity in mm/s	20 to 90	35 to 90	6 to 125	50 to 150
Drive screw pitch in mm	1, 2	2	2	5
Load capacity in N	100	350	1000	1500
Push / pull force in N	50	up to 150	80/80	up to 260
Motor type	DC motor, 2-phase stepper motor	DC motor, 2-phase stepper motor	Brushless DC motor (BLDC), DC gear motor, DC ActiveDrive, 2-phase stepper motor	DC motor, 2-phase stepper motor
Recommended controller	SMC controller	SMC controller	C-863 single-axis C-663 single-axis	SMC controller

Stepper motor resolution controller-dependent

# Nanometer Precision over Long Travel Ranges

## Fast Scans at Constant Velocity

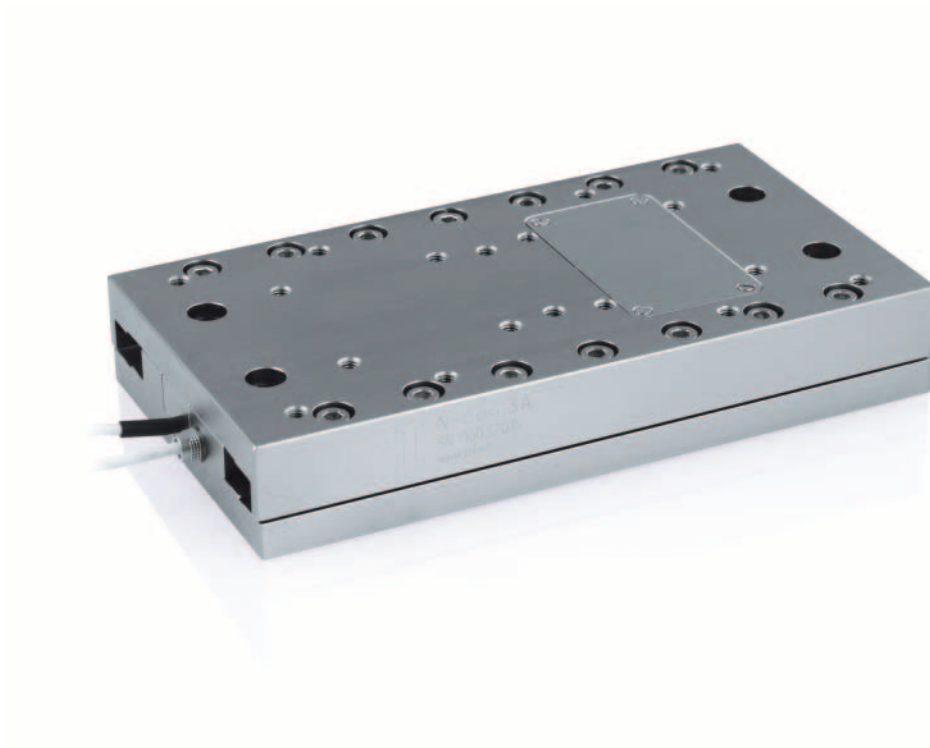

N-664

## Highlights

- Nanometer step sizes
- Direct position measurement
- Control within a few milliseconds

## Applications

In surface inspection, e.g. for white light interferometry, uniform feed at constant velocity and nanometer-precision positioning are essential. Fast scans also benefit from this.



M-511.HD



M-714



UPM-160

## M-511.HD

## M-714

## N-664

## UPM-160

Travel range in mm	100	7	30	55 to 205
Dimensions in mm	400 × 140 × 51.5	140 × 120 × 55	120 × 65 × 20	210 to 360 × 160 × 55 plus motor 120 × 60 × 55
Design resolution in nm	2	2	0.5	to 0.001
Min. incremental motion in $\mu\text{m}$	0.004	0.004	0.002	0.035 to 0.05
Unidirectional repeatability in $\mu\text{m}$	0.01	0.01	0.0005	0.035 to 0.05
Angular crosstalk (pitch / yaw) in $\mu\text{rad}$	$\pm 25$	$\pm 10$	$\pm 20$	$\pm 15$ to $\pm 30$
Velocity in mm/s	50	0.2	10	18 to 100
Drive screw pitch in mm	2	1	no spindle	2.5, 5
Load capacity in N	200	–	20	350
Push / pull force in N	80/80	100/100	10	100
Motor type	Hybrid: DC motor with piezo direct drive	Hybrid: DC gear motor with piezo direct drive	NEXACT® piezo stepping drive	DC motor, 2-phase stepper motor
Recommended controller	C-702 double-axis	C-702 double-axis	E-861 single-axis	SMC controller

Stepper motor resolution controller-dependent

# High-Speed Stages of Excellent Precision

Electromagnetic Linear Motor Combined with High-Resolution Encoder



UPS-150

## Highlights

- Direct drive without any additional mechanical components, thus fewer wear parts
- High velocities of several 100 mm/s
- Precision depends only on encoder and guides
- Combinable with highly dynamic direct-drive rotation stages
- Limit switches to protect the mechanical system

## Applications

Especially industrial applications use the reliability and excellent precision of these direct-drive stages. Their high dynamics ensures high throughputs of automated tasks in the area of testing systems for example in the semiconductor industry. They also increase efficiency, for example in electronics production lines or laser processing.

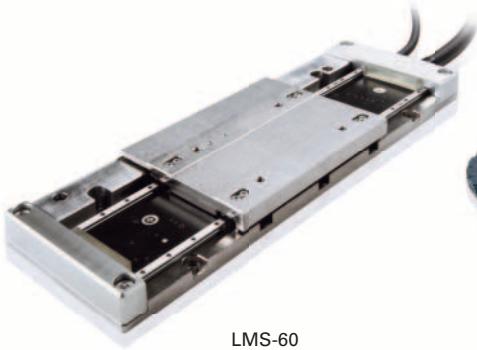

LMS-60

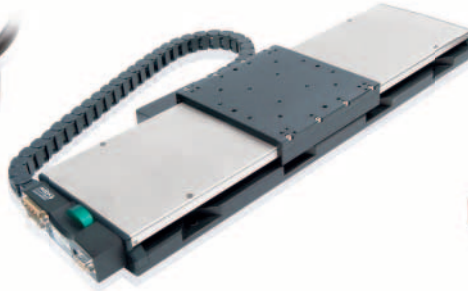

LMS-180



V-106

## LMS-60

## UPS-150

## LMS-180

## V-106

	15-nm linear encoder integrated	1-nm or 15-nm linear encoder integrated	15-nm linear encoder integrated	Voice-coil drive for high-speed scanning and positioning
Travel range in mm	25, 65	52 to 305	155 to 508	6, 20
Dimensions in mm	145 to 185 × 60 × 14	198 to 454 × 150 × 55	470 to 820 × 180 × 55	120 × 120 × 44
Design resolution in $\mu\text{m}$	0.015	0.001 to 0.015	0.015	0.1
Min. incremental motion in $\mu\text{m}$	0.1	0.015 to 0.02	0.04	0.2
Unidirectional repeatability in $\mu\text{m}$	0.1	0.015 to 0.025	0.05	0.2
Angular crosstalk (pitch / yaw) in $\mu\text{rad}$	$\pm 80$ to $\pm 100$	$\pm 15$ to $\pm 40$	$\pm 40$ to $\pm 80$	$\pm 25$
Velocity in mm/s	500	600	500	270
Load capacity in N	30	150	450	36, 81
Push / pull force in N	7 (typ.), 31 (max.)	22 (typ.), 88 (max.)	50 (typ.), 170 (max.)	5, 3.3
Recommended controller	SMC controller	SMC controller	SMC controller	C-863 single-axis

Stepper motor resolution controller-dependent

# Precision Z Stages

High-Accuracy Positioning of High Loads

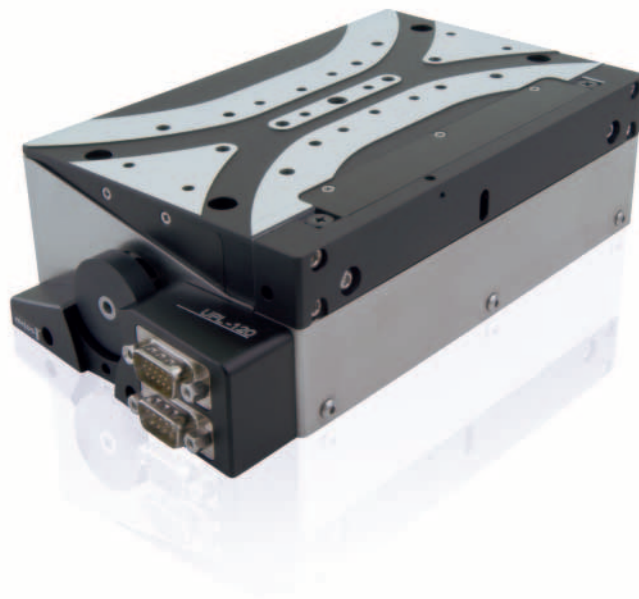

UPL-120

## Highlights

- For high loads
- Travel ranges of up to 13 mm
- With integrated limit switches

## Applications

Lithographic methods, wafer inspection or photonics have very high requirements in terms of the precision of positioning systems. These Z stages are designed especially for loads of up to 300 N, so that they can also carry additional axes, if necessary.



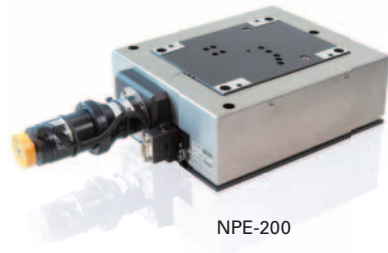

NPE-200



M-451

## UPL-120

## NPE-200

## M-451

		Excellent straightness / flatness	Compatible with piezo positioning stages
Dimensions in mm	170 × 110 × 55	238 × 200 × 85	154 × 150 × 95 plus motor 110 × 60 × 40
Travel range in mm	13	13	12.5
Design resolution in $\mu\text{m}$	to 0.013	0.001	to 0.0028
Min. incremental motion in $\mu\text{m}$	0.1 to 0.5	0.005	0.2
Unidirectional repeatability in $\mu\text{m}$	0.05 to 0.5	0.04	0.3
Angular crosstalk (pitch / yaw) in $\mu\text{rad}$	$\pm 100$	$\pm 20$	$\pm 75$
Velocity in mm/s	6	0.2	0.8 to 3
Drive screw pitch in mm	0.268	2	0.5
Load capacity in N	up to 200	300	120
Motor type	DC motor, 2-phase stepper motor	DC motor, gearhead	DC gear motor, DC ActiveDrive, 2-phase stepper motor
Recommended controller	SMC controller	SMC controller	C-863 single-axis C-663 single-axis

Stepper motor resolution controller-dependent

# Precision Z Stages

Combination with Linear and Rotation Stages



M-501

## Highlights

- Different load classes
- Travel ranges of up to 25 mm
- With integrated limit switches

## Applications

For motions in Z, elevation stages are available, which can be combined with linear positioning stages or rotation stages as compactly as possible. As an alternative to Z stages, linear positioning stages can be used for Z motions by means of adapter brackets, thus allowing also longer travel ranges to be achieved.

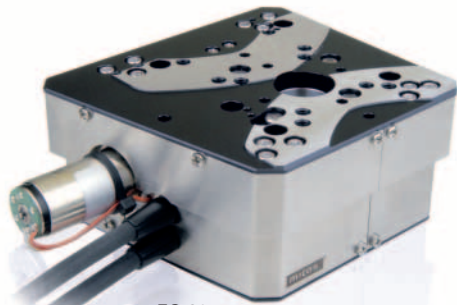

ES-82



ES-100

## ES-82

## ES-100

## M-501

	For combination with PLS-85, LS-65 and MTS-65	For combination with LS-110 and PRS-110	For direct mounting on M-511, M-521, M-531
Dimensions in mm	92 × 82 × 45	140 × 100 × 90 to 105	130 × 130 × 95
Travel range in mm	13	13 and 26	12.5
Design resolution in $\mu\text{m}$	up to 0.05	up to 0.05	up to 0.005
Min. incremental motion in $\mu\text{m}$	0.1 to 0.3	0.05 to 0.5	<0.1
Unidirectional repeatability in $\mu\text{m}$	0.1 to 0.3	0.05 to 0.5	0.1
Angular crosstalk (pitch / yaw) in $\mu\text{rad}$	$\pm 75$	$\pm 100$ to $\pm 150$	$\pm 15$
Velocity in mm/s	0.08 to 0.1	15 to 20	1 to 3
Drive screw pitch in mm	7	1	1
Load capacity in N	20	up to 55	50, 100
Motor type	DC motor, 2-phase stepper motor	DC motor, 2-phase stepper motor	DC gear motor, DC ActiveDrive
Recommended controller	SMC controller	SMC controller	C-863 single-axis

Stepper motor resolution controller-dependent

# Precision XY Stages

For Microscopy and Inspection Tasks

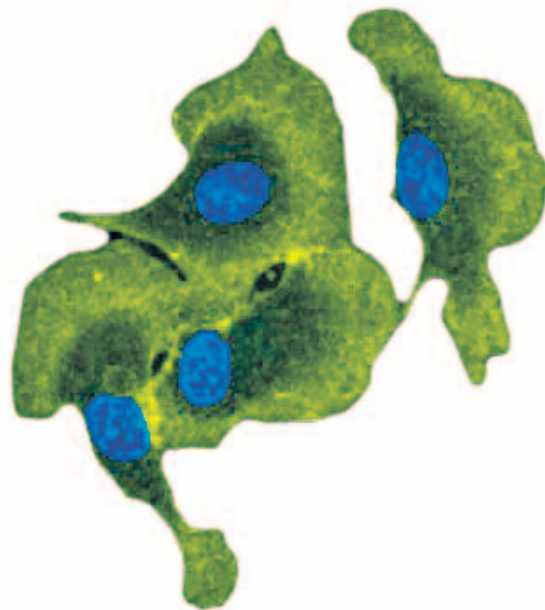

Endothelial cells as seen under the microscope (Source: Lemke Group, EMBL Heidelberg)



**Microscopy Stages**  
XY Stages with Clear Aperture

**Page 218**

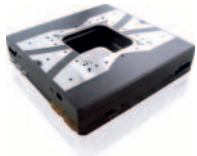

**Precision XY Stages**  
Scanners for Inspection and Microscopy Tasks

**Page 220**

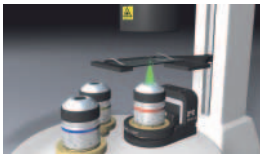

**Z Piezo Scanners for Microscopy**  
Fast and Precise Positioning of Objective and Sample

**Page 44**

# Microscopy Stages

## XY Stages with Clear Aperture

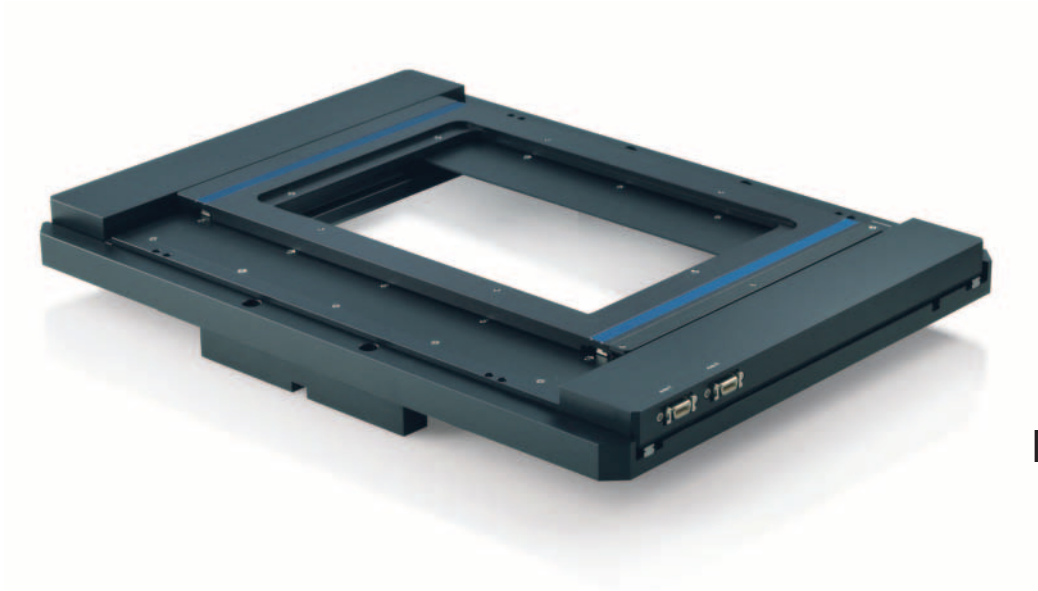

M-687

## Highlights

- Fit on common microscopes from known manufacturers such as Nikon, Zeiss, Leica and Olympus
- Stable positioning
- Low profile for easy integration
- Compact and flat design allows free access to sample
- High constant velocity even at velocities around 10  $\mu\text{m/s}$
- Suitable piezo scanning stages for XYZ and Z sample positioning available

## Applications

For superresolution microscopy, tiling, automated scanning microscopy

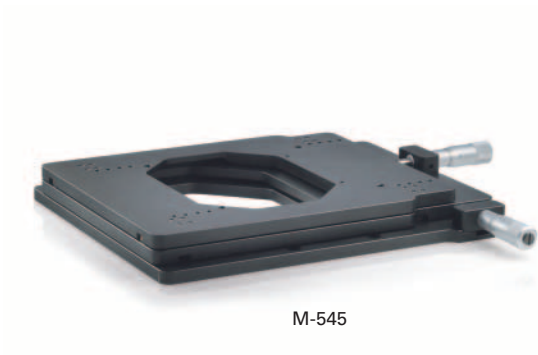

M-545



M-686

## M-545

## M-686

## M-687

	M-545	M-686	M-687
	Manual drive via micrometer screws, optional motorization	Dynamic through direct drive equipped with ultrasonic piezomotor	Dynamic through direct drive equipped with ultrasonic piezomotor
Suitable piezo scanning stages	P-545 PInano®	P-563 PIMars, P-541	P-736 PInano®
Clear aperture in mm	140 × 100 for object slides and Petri dishes	78 × 78	160 × 100 for multititer plates
Dimensions in mm	230 × 240 × 30	170 × 170 × 32	400 × 297 × 48 (for Nikon Eclipse Ti) 400 × 237 × 36 (for Olympus IX2)
Travel range in mm	25 × 25	25 × 25	135 × 85 (for Nikon Eclipse Ti) 100 × 75 (for Olympus IX2)
Design resolution in μm	0.046 (motorized)	0.1	0.1
Min. incremental motion in μm	1 (motorized)	0.3	0.3
Unidirectional repeatability in μm	2	0.3	0.3
Max. velocity in mm/s	1.5	100	120
Load capacity in N	50	50	50
Recommended controller	motorized system including controller and joystick	C-867 PLine® motion controller double-axis	system including controller and joystick

Stepper motor resolution controller-dependent

# Precision XY Stages

Scanners for Inspection and Microscopy Tasks

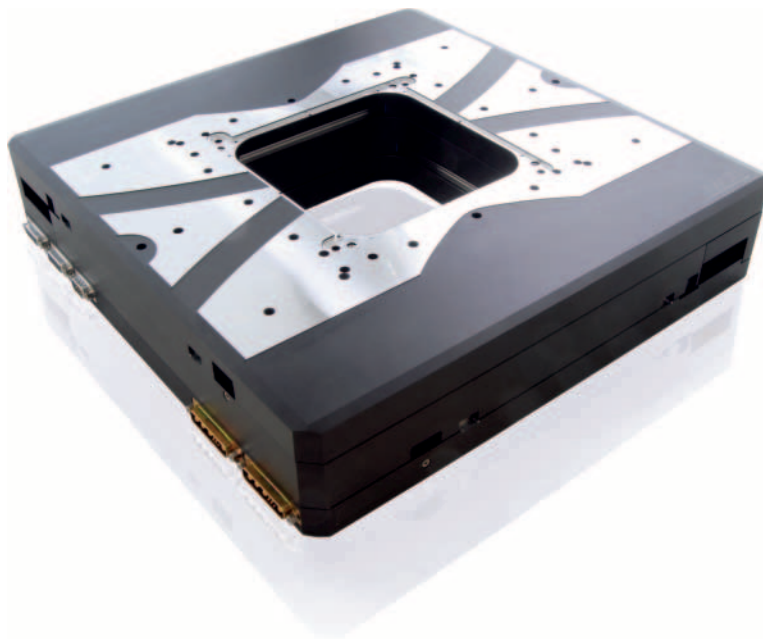

MCS

## Highlights

- Stable platforms equipped with electric motors
- With clear aperture suitable for transmitted light and incident light microscopy
- Optionally with linear encoder
- Minimum flatness error

## Applications

The guiding and position accuracy of these microscopy XY stages is required in particular in industrial metrology. Its areas of applications include industrial surface measurement technologies such as topology measurements on workpieces and optics or structural measurements on semiconductor wafers. Their high loads allow further axes, e.g. those of rotary stages, Z modules and tilt stages to be mounted on the platform.





CS-430



M-880

## MCS

## CS-430

## M-880

	MCS	CS-430	M-880
Dimensions in mm	380 × 380 × 80	430 × 430 × 100	600 × 600 × 105
Clear aperture in mm	150 × 150	–	Ø 160
Travel range in mm	102 × 102 205 × 205 / 305 × 305 on request	350 × 300	20 × 20 $\theta_z: 8^\circ$
Design resolution in $\mu\text{m}$	0.005 to 0.2	to 0.05	–
Min. incremental motion in $\mu\text{m}$	to 0.005	0.1 to 0.5	–
Unidirectional repeatability in $\mu\text{m}$	0.2	0.1 to 0.5	0.5
Crosstalk in $\mu\text{rad}$	$\pm 40$ / $\pm 20$	$\pm 80$	–
Max. velocity in mm/s	35 to 300	100	20
Load capacity in N	200	300	1500 (holding force)
Push / pull force in N	80 to 200	110	200
Motor type	2-phase stepper motor, DC motor, linear motor	2-phase stepper motor	DC-motor ActiveDrive
Recommended controller	SMC controller	SMC controller	system including controller

# Precision Rotary Stages

---



Two rotation stages are connected via a bracket and form a 2-circle goniometer: a Cardanic joint with a common pivot point

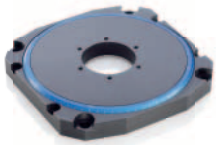

**Small Rotation Stages Equipped with Piezomotors**  
Dynamic Direct Drive

Page 224



**Small Rotation Stages Equipped with Electric Motors**  
For Compact Stacked Multi-Axis Positioning Systems

Page 226



**Precision Rotation Stages**

Page 228



**Ultraprecise Rotation Stages**  
Reference-Class Rotation Stages for the Most Demanding Requirements

Page 230



**Goniometers and Tip/Tilt Stages**  
1- or 2-Axis Motion

Page 232

# Small Rotation Stages Equipped with Piezomotors

Dynamic Direct Drive

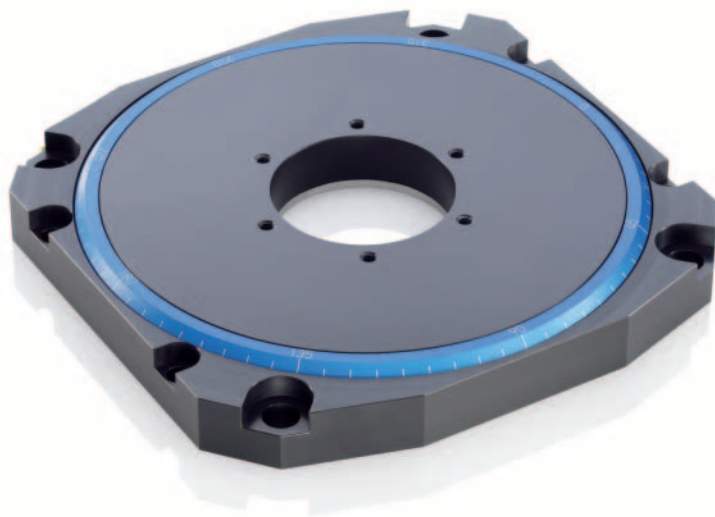

M-660

## Highlights

- Excellent start/stop dynamics
- Compact combinations with linear positioning stages possible
- Direct metrology: Integrated optical encoders for direct position measurement
- Self-locking when at rest, no heat generation, no servo jitter
- Excellent guiding accuracy
- Vacuum versions available

## Applications

These miniature stages can be used in a wide range of applications, for example in materials testing or for equipment of beamlines on accelerator rings. Their piezo drive is in general vacuum-compatible and nonmagnetic, while the stages themselves are very compact.

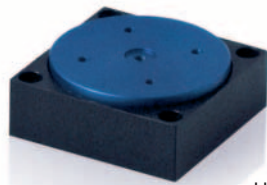

U-624



U-628

## M-660

## U-624

## U-628

		Preliminary data	Preliminary data
Dimensions in mm	116 × 116 × 14	30 × 30 × 12	50 × 50 × 16
Rotation range in °	no limit	no limit	no limit
Design resolution in $\mu\text{rad}$ (°)	4 / 34 (0.0002 / 0.002)	10 (0.0006)	3 (0.0002)
Min. incremental motion in $\mu\text{rad}$ (°)	12 / 34 (0.0007 / 0.002)	70 (0.004)	10 (0.0006)
Max. velocity in °/s	720	> 360	> 720
Load capacity (axial force) in N	20	2	20
Torque in Nm	0.3	0.02	0.05
Drive	ultrasonic piezomotor	ultrasonic piezomotor	ultrasonic piezomotor
Recommended controller	C-867 PLine® motion controller	C-867 PLine® motion controller	C-867 PLine® motion controller

# Small Rotation Stages Equipped with Electric Motors

For Compact Stacked Multi-Axis Positioning Systems

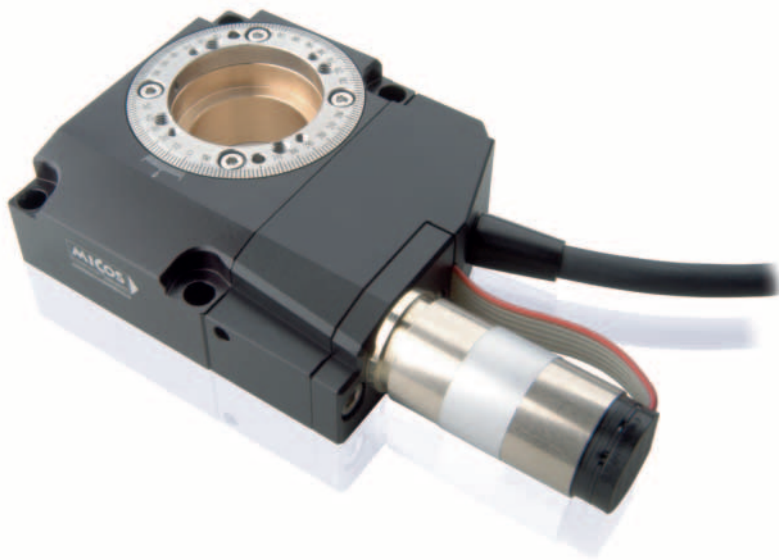

RS-40

## Highlights

- Unlimited rotation range with contactless reference point switch
- Precision stages for minimized backlash

## Applications

Many applications in microscopy require free light passage. These compact rotation stages can also be used in optics applications, where they position, for example, filters, reliably and with excellent repeatability.



DT-34



M-116



DT-65 N

## DT-34

## M-116

## RS-40

## DT-65 N

	DT-34	M-116	RS-40	DT-65 N
Drive details	Preloaded belt drive	Backlash-compensated worm drive	Backlash-compensated worm drive	Backlash-compensated worm drive, preloaded double-row ball bearings for minimal tilt
Clear aperture Ø in mm	10	19	20	25
Dimensions in mm	34 × 58 × 18.5	66 × 70 × 23.5	56 × 64 × 20	70 × 92.5 × 25
Design resolution in µrad (°)	to 0.7 (0.00004)	2.5 (0.00015)	to 0.5 (0.00003)	to 17 (0.001)
Unidirectional repeatability in µrad (°)	700 (0.04)	10 to 12 (0.0006 to 0.0007)	90 (0.005)	35 (0.002)
Max. velocity in %/s	675	20	7	60
Load capacity in N	15	15	20	30
Torque in Nm	up to 0.9	up to 1.5	0.2	0.8
Motor type	2-phase gear stepper motor, DC gear motor	DC gear motor, 2-phase stepper motor	2-phase gear stepper motor, DC gear motor	2-phase stepper motor, DC motor
Recommended controller	SMC controller	C-863 single-axis C-663 single-axis	SMC controller	SMC controller

Stepper motor resolution controller-dependent

# Precision Rotation Stages

---



PRS-110

## Highlights

- Backlash-compensated worm drive
- Unlimited rotation range with contactless reference point switch

## Applications

These high-precision rotation stages are used in many areas of application in industry and research. Test equipment in materials testing or optical metrology in photonics production benefits from the excellent travel accuracy and the uniform feed.



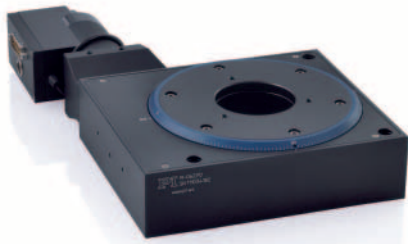

M-062



DT-80 R

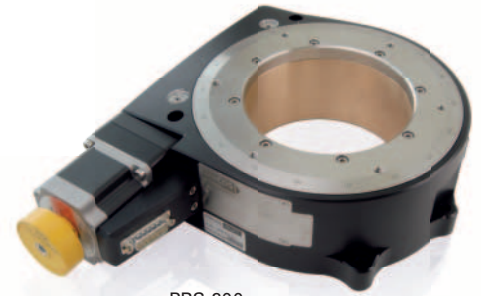

PRS-200

M-060  
M-061  
M-062

DT-80  
DT-80 R

PRS-110

PRS-200

Special features	Available with manual drive	Belt transmission version for high velocity >3 revolutions/second	Preloaded and calibrated bearings for minimal tilt	Preloaded ball bearings for minimal tilt
Clear aperture Ø in mm	20 to 45	40	35	120
Rotary plate Ø in mm	60 to 120	64	85	190
Dimensions in mm	90 × 70 × 29 to 150 × 130 × 38 plus motor	83 × 86 × 30 plus motor	125 × 110 × 55 plus motor	225 × 200 × 75 plus motor
Design resolution in µrad (°)	to 0.96 (0.00006)	to 17 (0.001)	to 1.7 (0.0001)	to 1.3 (0.00008)
Min. incremental motion in µrad (°)	to 5 (0.0003)	to 17 (0.001)	to 1.7 (0.0001)	to 1.3 (0.00008)
Unidirectional repeatability in µrad (°)	to 50 (0.003)	170 (0.01)	to 3.5 (0.0002)	to 5.2 (0.0003)
Max. velocity in %/s	90	40 high-speed version: 1170	200	150
Load capacity in N	500 to 650	20	100	500
Torque in Nm	4 to 8	0.1	3	4
Motor type	DC motor, ActiveDrive, DC gear motor, 2-phase stepper motor	2-phase stepper motor, DC motor	2-phase stepper motor, DC motor	2-phase stepper motor, DC motor
Recommended controller	C-863 single-axis C-663 single-axis	SMC controller	SMC controller	SMC controller

Stepper motor resolution controller-dependent

# Ultraprecise Rotation Stages

Reference-Class Rotation Stages for the Most Demanding Requirements



UPR-120

## Highlights

- Optionally, all series are available with air bearings for motion without wobble and zero-backlash caused by friction effects
- Brushless torque motors for particularly smooth synchronous running even at low velocities
- Unlimited rotation range with contactless reference point switch
- Direct position measurement

## Applications

These reference-class rotation stages are aimed at applications that require simultaneously high dynamics and high positioning precision. Research areas such as beam lines or semiconductor technology with their high accuracy and throughput requirements are the target markets.



UPR-100



UPR-160

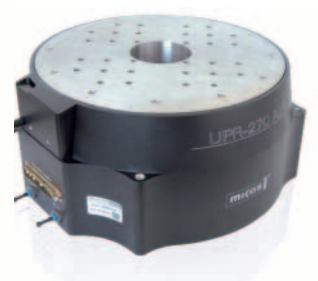

UPR-270

## UPR-100

## UPR-120

## UPR-160

## UPR-270

Out of plane and eccentricity with air bearing	<±0.2 μm	<±0.1 μm	<±0.1 μm	<±0.1 μm
Clear aperture Ø in mm	20	35	35	35
Dimensions in mm	100 × 100 × 50	155 × 129 × 90	178.4 × 165 × 90	281 × 270 × 135
Design resolution in μrad (°)	0.17 (0.00001)	0.17 (0.00001)	0.17 (0.00001)	0.17 (0.00001)
Min. incremental motion in μrad (°)	0.35 (0.00002)	0.35 (0.00002)	0.35 (0.00002)	0.17 (0.00001)
Unidirectional repeatability in μrad (°)	1.4 (0.00008)	1.4 (0.00008)	1.4 (0.00008)	1.2 (0.00007)
Max. velocity in °/s	360	360	360	360
Load capacity in N	15 to 20	200	200	400
Max. torque in Nm	0.25 to 0.5	2	2	10
Recommended controller	SMC controller	SMC controller	SMC controller	SMC controller

# Goniometers and Tip/Tilt Stages

## 1- or 2-Axis Motion

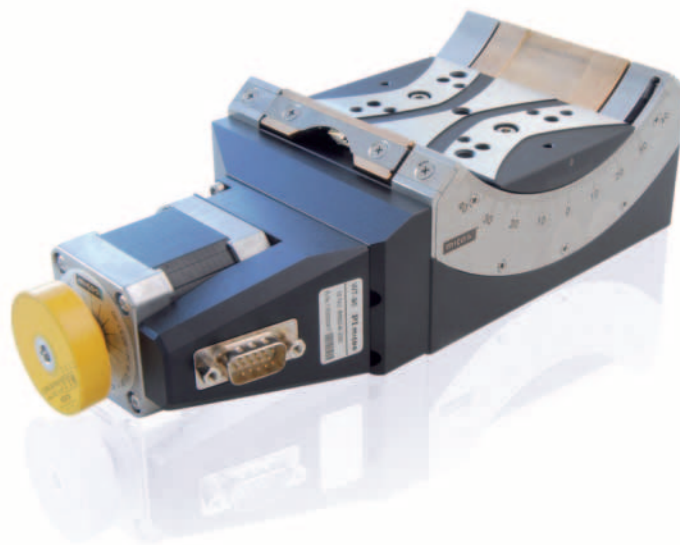

WT-90

## Highlights

- Excellently smooth performance and uniform feed at constant angular velocity
- Rotational axis above platform in goniometers or at platform level in tilt stages
- Common pivot point possible for WT-85 on WT-100, WT-90 on WT-120
- Vacuum versions available on request

## Applications

Goniometers can replace rotation stages in applications of restricted installation space. This is advantageous, for example, for laser technology and materials research, where optical elements have to be positioned in the beam guidance. For scanning or tracking applications, the motorized tip/tilt stages can be equipped with a high-resolution piezo drive. For particularly high dynamics piezo tip/tilt mirror systems are available, depending on the application.

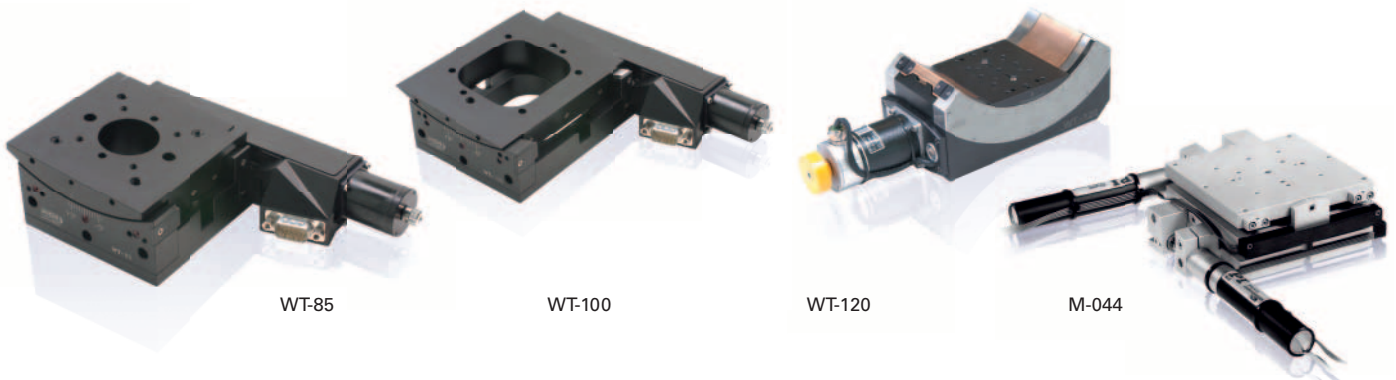

WT-85

WT-100

WT-120

M-044

## WT-85

## WT-100

## WT-90 WT-120

## M-041 bis M-044

	Goniometer with clear aperture $\varnothing$ 30 mm	Goniometer with clear aperture 60 x 25 mm <sup>2</sup>	Goniometer for high loads with wide adjustment range	Tilt stage with 1 or 2 axes and large platform
Special features	optionally direct position measurement	optionally direct position measurement	optionally direct position measurement	drive zero-backlash magnetically coupled
Rotation / tilt range in °	10	10	90	14 to 18
Dimensions in mm	85 x 130.5 x 44 plus motor	132 x 158 x 37 plus motor	115 x 125 x 61 (WT-90) 150 x 235 x 106 (WT-120) plus motor	60 x 60 x 27 to 100 x 100 x 47 plus motor
Design resolution in $\mu$ rad (°)	to 1.7 (0.0001)	to 1.6 (0.00009)	to 1.6 (0.00009)	to 0.23
Min. incremental motion in $\mu$ rad (°)	to 87 (0.005)	to 87 (0.005)	to 17 (0.001)	to 65 (0.004) manually 15 (0.001) motorized
Unidirectional repeatability in $\mu$ rad (°)	to 87 (0.005)	to 87 (0.005)	to 17 (0.001)	to 15 (0.001)
Max. velocity in %/s	7 to 15	7 to 15	15 to 30	up to 4.5
Load capacity in N	20	20	80, 200	4 to 5
Torque in Nm	0.75	0.75	2.5, 8	up to 0.75
Drive	2-phase stepper motor, DC motor	2-phase stepper motor, DC motor	2-phase stepper motor, DC motor	DC motor, optionally supplemented by piezo drive. For manual stages, see <a href="http://www.pi.ws">www.pi.ws</a>
Recommended controller	SMC controller	SMC controller	SMC controller	C-863 single-axis

Stepper motor resolution controller-dependent

# Motorized Precision Linear Actuators

---

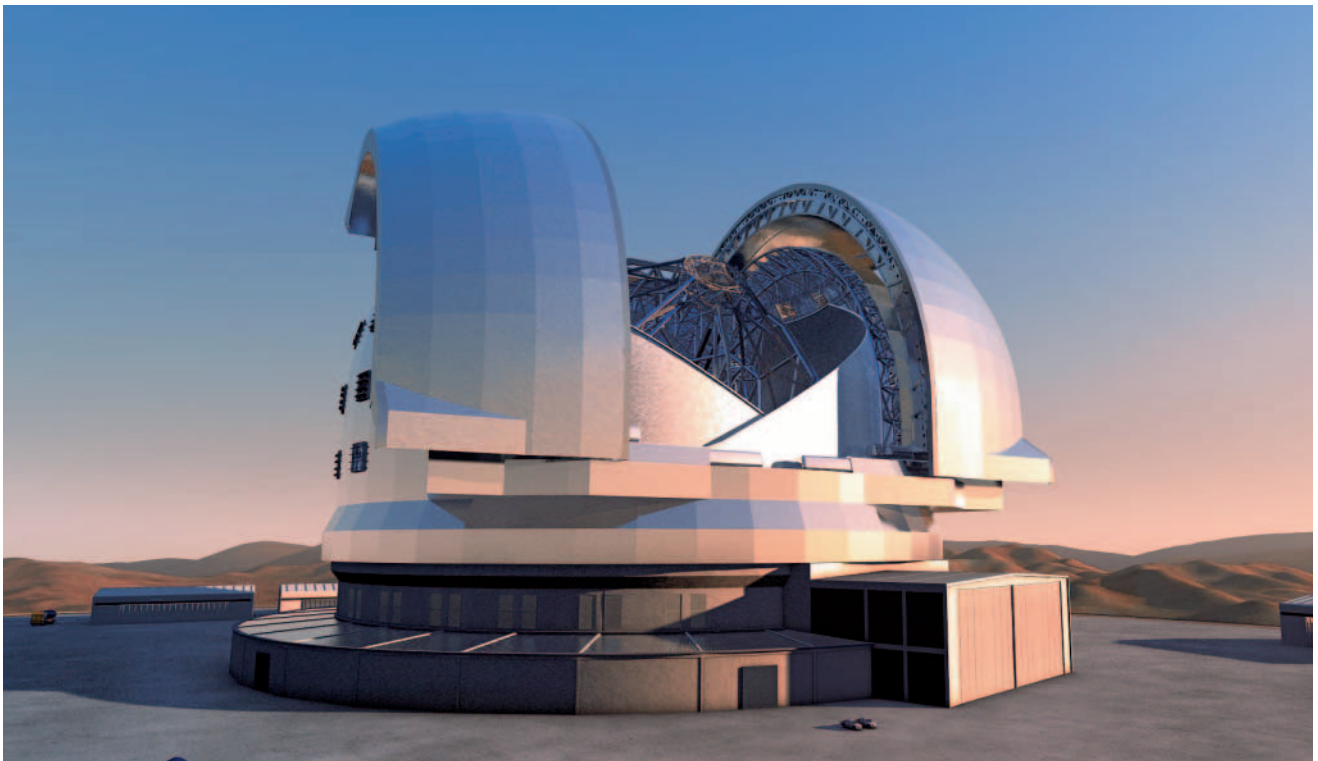

The E-ELT, the "largest eye" for looking into space, has a primary mirror of approx. 39 m in diameter consisting of nearly eight hundred hexagonal mirror elements. Each mirror element is positioned by three linear actuators using high-precision drive technology. (Figure: European Southern Observatory, ESO)



**Precision Actuators**

**Page 236**



**Cost-Efficient Linear Actuators**

**Page 238**



**High-Load Actuators**

**Page 240**



**Compact Linear Actuators**

For Alignment of Optomechanical Components

**Page 242**

# Precision Actuators



M-230

## Highlights

- High-resolution drives combined with precision components
- Backlash-compensated design with nonrotating end piece
- Vacuum versions available

## Applications

These positioners offer compact solutions for restricted installation space, for example in testing and inspection systems in industry and research. Their nonrotating end piece with uniform motion prevents wobble, torque, and wear at the point of contact. Especially the actuators with piezomotor are ideal for use as micro- and nano-manipulators, for example in bio- and nanotechnology.



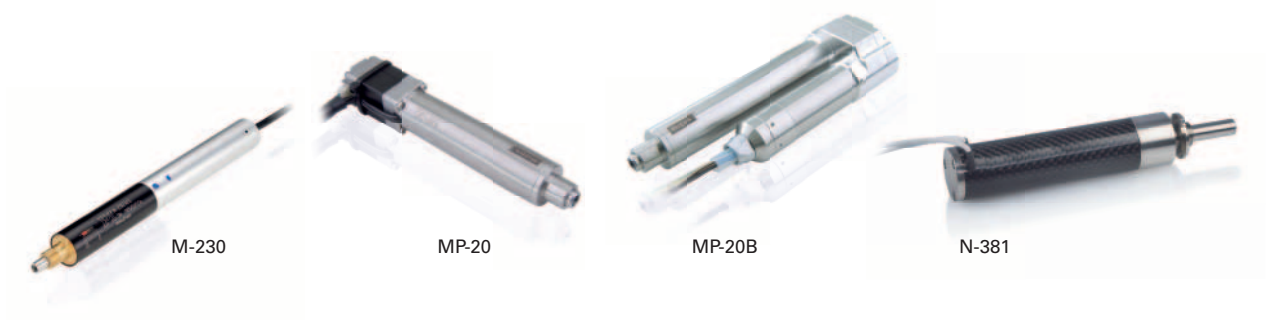

M-230

MP-20

MP-20B

N-381

	M-230	MP-20	MP-20B	N-381
	High resolution	Flexible travel range	Highly compact through folded drive	Nanometer precision with piezomotor, optionally nonmagnetic
Dimensions in mm	Ø 19 x 175 to 205	Ø 20 x 124.5 to 196.5	30 x 47.9 x 100 to 143	Ø 25 x 121.5
Travel range in mm	10 to 25	13 to 76	13 to 76	30
Axial force in N	up to 70	up to 125	up to 110	10
Permissible lateral force in N	up to 30	1	1	10
Max. velocity in mm/s	1.2 to 2	0.8 to 12	0.6 to 10	10
Design resolution in nm	4.6 to 37	22	22	20, 0.03 open-loop
Min. incremental motion in µm	0.05	0.1	0.1	0.02
Backlash in µm	2	2	2	0.2
Unidirectional repeatability in µm	±0.1	±0.3	±0.3	0.1
Encoder type	rotary encoder	rotary encoder	rotary encoder	linear encoder
Motor type	DC gear motor, 2-phase stepper motor	2-phase stepper motor, DC gear motor	2-phase stepper motor, DC gear motor	NEXACT® piezo stepping drive
Recommended controller	C-863 single-axis C-884 up to 4 axes C-663 single-axis	SMC controller	SMC controller	E-861 single-axis

Stepper motor resolution controller-dependent

# Cost-Efficient Linear Actuators

---

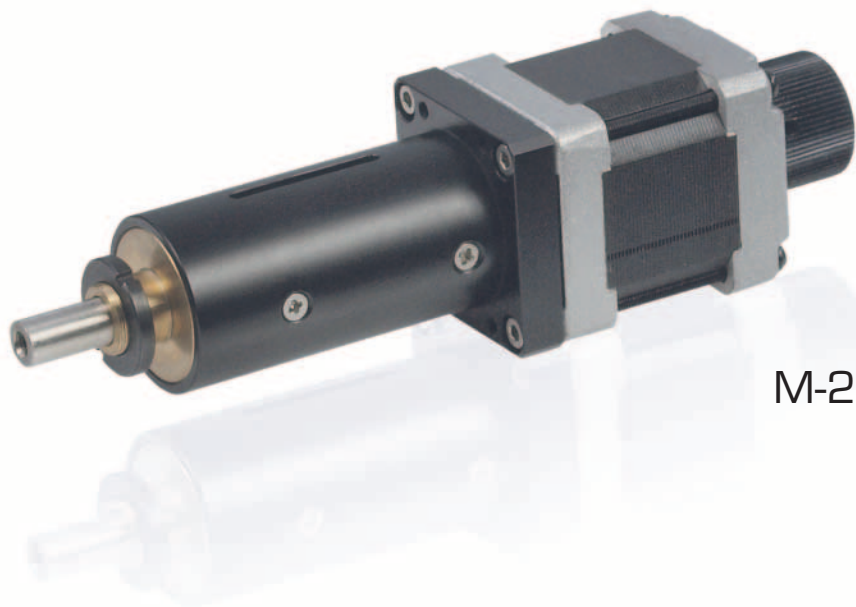

M-229

## Highlights

- Stepper motors with and without gearhead, DC servo motor or closed-loop piezomotor
- Nonrotating end piece for uniform linear motion prevents wobble, torque, and wear at the point of contact

## Applications

Cost-sensitive applications benefit from the low system cost of the linear axes. They are also highly suitable for OEM applications in several axes. As an alternative to motor-spindle combinations or electromagnetic linear motors, the ceramic direct drive offers self-locking when at rest without generation of heat.



M-228  
M-229

M-228  
M-229

M-227

M-272

	Handwheel, integrated position indicator	Integrated position indicator	High precisions, optionally with piezo drive	Minimizes backlash through linear direct drive
Dimensions in mm	39 x 39 x 100 to 120	Ø 21 x 100 Ø 30 x 135	Ø 19 x 125 to 187	26 x 40 x 130
Axial force in N	20, 50	50, 80	40	8
Permissible lateral force in N	up to 0.5	up to 0.5	0.1	10
Travel range in mm	10, 25	10, 25	10, 50	50
Max. velocity in mm/s	1.5	1.5	0.75	150
Design resolution in µm	0.046	0.046	0.0035	0.6 with direct metrology
Min. incremental motion in µm	0.15	0.15	0.05	1.8
Backlash in µm	5 to 10	5 to 10	2	1
Unidirectional repeatability in µm	±2	±2	±0.1	±2
Encoder type	–	–	rotary encoder	linear encoder
Motor type	2-phase stepper motor	2-phase stepper motor with gearhead	DC gear motor, stepper motor variant M-168 online	U-164 PILine® ultrasonic piezomotor
Recommended controller	C-663 single-axis	C-663 single-axis	C-863 single-axis C-884 up to 4 axes	C-867.OE

# High-Load Actuators

---



## Highlights

- Lateral guiding of the pusher for lateral forces of up to 100 N
- Powerful drives equipped with precision components
- Backlash-compensated design
- Nonrotating end piece with uniform motion prevents wobble, torque, and wear at the point of contact

## Applications

High load capacity combined with high dynamics is the distinguishing feature of these actuators. Loads of 100, 200 or even 500 N are positioned with high precision, reliability and repeatability. PI offers the right solution both for testing and inspection systems and for use in production lines in precision mechanical engineering.



M-235



M-238

## M-235

## MA-35

## MA-35

## M-238

	M-235	MA-35	MA-35	M-238
Dimensions in mm	Ø 27 × 166 to 196	Ø 40 × 249	Ø 40 × 275 to 300	Ø 42 × 247.2
Axial force in N	up to 120	500	up to 300	400
Permissible lateral force in N	8	10	10	100
Travel range in mm	20 to 50	52	52	50
Max. velocity in mm/s	2.6 to 30	up to 5	up to 90	30
Design resolution in µm	0.016 to 0.5	to 0.01	0.5	0.13 to 0.1
Min. incremental motion in µm	0.1 to 0.5	to 0.1	to 0.1	0.5 to 0.3
Backlash in µm	1	2	2	3 / 1
Unidirectional repeatability in µm	0.1 to 0.5	0.2	to 0,2	1 to 0.3
Motor type	DC gear motor, DC motor, 2-phase stepper motor	DC gear motor	DC motor, 2-phase stepper motor	DC motor, ActiveDrive
Recommended controller	C-863 single-axis C-884 up to 4 axes C-663 single-axis	SMC controller	SMC controller	C-863 single-axis C-884 up to 4 axes

Stepper motor resolution controller-dependent

# Compact Linear Actuators

For Alignment of Optomechanical Components



N-470 PiezoMike

## Highlights

- Precision-class linear drives
- High-quality components
- Motorization of manual positioning stages

## Applications

The compact micro pushers are ideally suitable for stable positioning of optical components. Classical motorized linear axes fit directly on manual positioning stages and mirror stages. PIShift drives are suitable in particular for drift-free long-term positioning.



MP-15

M-231

M-232

N-470

	MP-15	M-231	M-232	N-470
	Vacuum variants up to 10 <sup>-6</sup> hPa available	Slim gear motor	Highly compact through folded drive	PIShift piezomotor of high holding force
Dimensions in mm	Ø 17 × 85 to 108	Ø 19 × 134	20 × 49 × 72	16 × 28 × 48
Travel range in mm	6, 12.7	17	17	7.4
Axial force in N	10	40	40	22 active, holding force > 100 N
Max. velocity in mm/s	0.3	1.5	1.5	0.06
Design resolution in µm	to 0.05	0.007	0.007	–
Min. incremental motion in µm	0.2	0.1	0.1	0.03
Backlash in µm	20	2	2	–
Unidirectional repeatability in µm	0.5	±0.2	±0.2	–
Motor type	DC gear motor, 2-phase stepper motor	DC gear motor, 2-phase stepper motor	DC gear motor, 2-phase stepper motor	PIShift piezo inertia drive
Recommended controller	SMC controller	C-863 single-axis C-884 up to 4 axes	C-863 single-axis C-884 up to 4 axes	E-870

Stepper motor resolution controller-dependent

# Motion Controllers

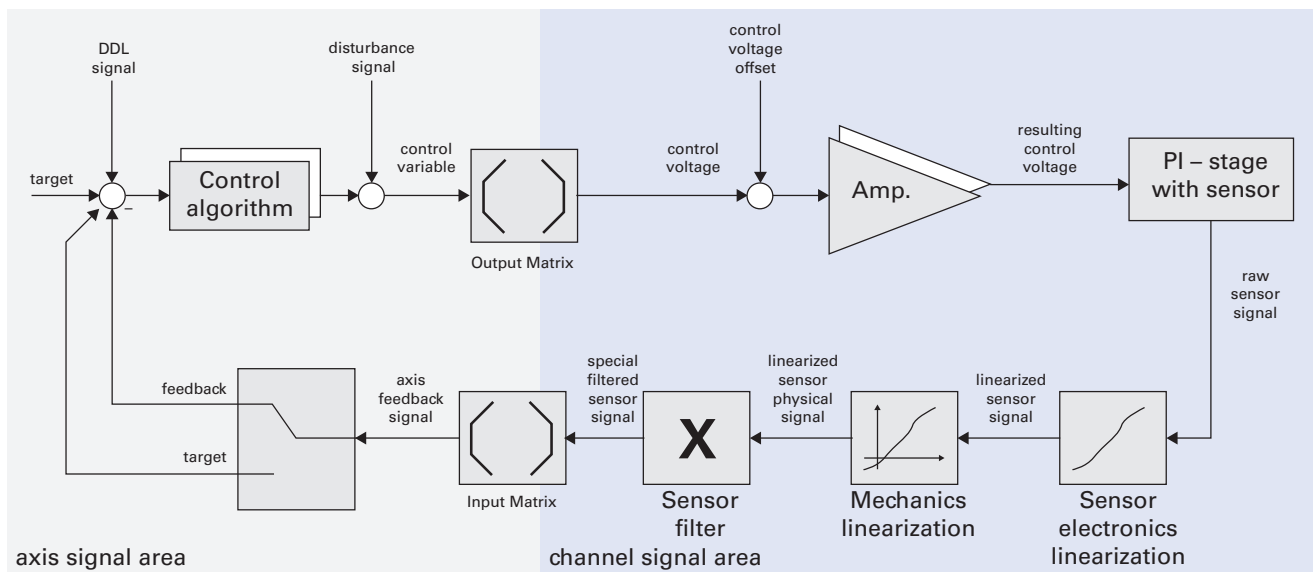

## Customized Closed-Loop Control of a Mechanical System Featuring Integrated Active Vibration Damping

A crucial factor for the precision can be the decoupling of low-frequency ambient vibrations, which excite resonances in the mechanical system, thus interfering in high-precision positioning. Piezo actuators use a specifically developed 6D acceleration sensor and a suitable digital controller to suppress the excitations in the range up to approx. 50 Hz. Digital linearization algorithms for the mechanical and electronic systems and filter functions for the sensor signals further enhance performance by suppressing multidimensional vibrations with damping factors of more than 20.





**DC Servo Motor Controllers**

**Page 246**



**Stepper Motor Controllers**

**Page 248**



**Digital Controllers for Piezomotors**

**Page 250**

# DC Servo Motor Controllers



C-884

## Highlights

- PID servo control, parameter change on the fly
- User-friendly PIMikroMove user software
- Motion control of PI positioning systems with DC motors: direct motor control, PWM control for PI positioning stages with integrated ActiveDrive amplifiers or for stages with integrated block commutation (brushless motors). Supports motor brakes
- Data recorder. Parameter change on the fly. Extensive software support, for example for LabVIEW, dynamic libraries for Windows or Linux
- Linear vector motion in multi-axis controllers



C-863

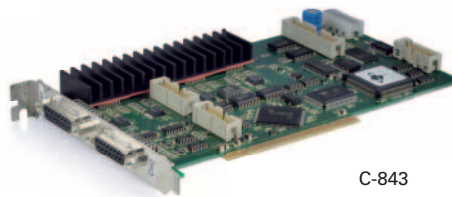

C-843

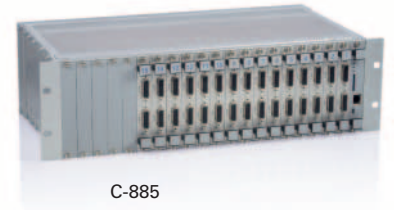

C-885

## C-863

## C-884

## C-843

## C-885

	C-863	C-884	C-843	C-885
	Motion controller for 1 axis	Motion controller for 4 axes	PCI motor control card for 2 or 4 axes	Modular controller design, modules for different drive technologies
Channels	1	4	2, 4	up to 40
Profile Generator	trapezoid velocity profile	trapezoid velocity profile	trapezoid or S-curve velocity profile	trapezoid velocity profile
Interface / Communication	USB, RS-232	TCP/IP, USB, RS-232	PCI-Bus	TCP/IP, USB
I/O ports	analog/digital inputs, digital outputs	analog/digital inputs, digital outputs	digital inputs and outputs	digital inputs and outputs
Software drivers	LabVIEW drivers, dynamic libraries for Windows and Linux	LabVIEW drivers, dynamic libraries for Windows and Linux	LabVIEW drivers, GCS-DLL	LabVIEW drivers, dynamic libraries for Windows and Linux
Supported functionality	point-to-point motion, powerful macro programming language, stand-alone operation	linear vector motion, point-to-point motion, powerful macro programming language, stand-alone operation	trigger programming	point-to-point motion, powerful macro programming language, stand-alone operation
Manual control	pushbutton box, joystick	USB interface for HID-compliant devices	only via PC	-
Operating voltage	power supply included in scope of delivery	power supply included in scope of delivery	supply via PC	integrated power supply
Dimensions	130 × 76 × 40 mm <sup>3</sup>	320 × 150 × 80.5 mm <sup>3</sup>	PCI card	19-inch case

# Stepper Motor Controllers

---



SMC hydra

## Highlights

- Sensor signal processing and PID servo control for 2-phase-stepper motor drives
- Data recorder. Parameter change on the fly
- Linear vector motion in multi-axis controllers
- SMC Controllers use a special technology with up to 300 000-fold microstepping. The effect is an extremely high precision positioning. In combination with a position feedback sensor, a particularly smooth motion and excellent tracking accuracy.



SMC corvus



SMC pollux



C-663

## SMC corvus

## SMC hydra CM

## SMC pollux

## C-663

	SMC corvus	SMC hydra CM	SMC pollux	C-663
	Also available as PCI card or bench-top	Also available for other motor types such as DC motors, linear motors, etc.	Optionally with integrated motor	-
Dimensions in mm	70 x 240 x 305	48 x 56 x 150	48 x 56 x 77	130 x 76 x 40
Channels	2, 3	2	1	1
Microstepping	>60000	>60000	>60000	16
Interface / Communication	RS-232, TCP/IP, GPIB	RS-232, TCP/IP	RS-232	USB, RS-232
Controller network	-	-	up to 16 units on single interface	up to 16 units on single interface
I/O ports	optionally digital inputs and outputs	optionally digital inputs and outputs	-	analog/digital inputs, digital outputs
Command set	Venus-1 ASCII	Venus-3 ASCII	Venus-2 ASCII	PI General Command Set (GCS)
Software drivers	LabVIEW drivers, dynamic libraries for Windows	LabVIEW drivers, dynamic libraries for Windows	LabVIEW drivers, dynamic libraries for Windows	LabVIEW drivers, dynamic libraries for Windows and Linux
Supported functionality	position control, linear vector motion, point-to-point motion	position control, linear vector motion, point-to-point motion	position control, linear vector motion, point-to-point motion, start-up macro	start-up macro
Manual control	joystick, 3-axis hand-wheel	joystick, 3-axis hand-wheel	-	joystick, pushbutton box
Current limitation/ motor phase in A	3	3	1.2	1
Operating voltage	90 to 250 V	external power supply	external power supply	power supply included in scope of delivery

# Digital Controllers for Piezomotors



E-871

## Highlights

- Extensive software support, e.g. for LabVIEW, shared libraries for Windows and Linux.  
Data recorder, e.g. for position values
- Processing of incremental sensors
- Analog I/O, e.g. for connection to joystick, and digital I/O for automation applications
- Integrated drivers, optimized for the corresponding drive type, e.g. with auto-resonant ultrasonic frequencies or concerted displacement of shear and longitudinal actuators
- Alternative: Driver electronics without integrated control for designing an external servo loop



E-755



E-861



C-867

## E-755

## E-861

## E-871

## C-867

	For NEXLINE® piezo stepping drives	For NEXACT® piezo stepping drives	For PIShift piezo inertia drives	For PILINE® ultrasonic drives
Special features	linearization with polynomials for perfect linearity of motion, deviation approx. 0.001% over the entire travel range of the NEXLINE® nanopositioning stage	supports all motion modes: Point-to-point-motion, analog mode for nanometer-precise positioning at target position. Non-volatile macro memory	supports all motion modes: Point-to-point-motion, analog mode for nanometer-precise positioning at target position. Non-volatile macro memory	supports all motion modes: Point-to-point-motion, slow motion at $\mu\text{m/s}$ , precise step-and-settle. Non-volatile macro memory
Interfaces / Communication	RS-232	USB, RS-232	USB, RS-232	USB, RS-232
Multi-axis control	up to 16 units via daisy chain. E-712 modular multi-axis controller for different drive modes available	up to 16 units via daisy chain. E-712 multi-axis controller	up to 16 units via daisy chain	up to 16 units via daisy chain. 2-axis controller available
Open-loop designs / drive electronics	open-loop designs available	E-862 OEM drive electronics available	E-870 OEM drive electronics available	OEM version in euro-card format or C-872 OEM driver electronics available

# Basics of Motorized Positioning Systems

---

---

## **Motors and Drives**

**Page 253**

Linear Drives – Piezo Drives – Rotating Electric Motors – Combinations of Piezo Actuator and Electric Motor

---

## **Drive Train Elements**

**Page 257**

Gearheads – Types of Drive Screw

---

## **Metrology**

**Page 258**

Indirect Metrology – Direct Metrology – Extended Metrology Concepts

---

## **Guidings and Bearings**

**Page 259**

Linear Guides – Air Bearings – Flexure Guides

---

## **Use in Vacuum**

**Page 261**

Decisive: Material Selection – Preferred Materials – Mounting in Cleanrooms – Important Factors for Vacuum Stages – Controllers, Amplifiers and Other Electronic Devices – Adapting Stages to Different Classes of Vacuum

---

## **SMC Controller Technology**

**Page 263**

Precision Positioning with SMC Controller – Position Control, Velocity and Correction of Position Errors in the Controller

---

## **Glossary**

**Page 266**

---



# Motors and Drives

## Linear Drives

Linear drives basically allow for unlimited travel ranges. They are direct-drive systems; they do not use drive screws or gearheads and are backlash-free. The positioning accuracy of the overall system is only affected by the position measurement and the guides.

### Electromagnetic Linear Drives

Linear servo motors are used both for very high and for very low feed velocities. They work precisely in a range from 0.1  $\mu\text{m/s}$  to more than 5 m/s. If combined with air bearings, a position resolution down to a few nanometers is possible.

### Voice-Coil Linear Drives

These friction-free electromagnetic linear drives are characterized by their good dynamics, albeit with relatively low holding force. They are used primarily in scanning applications with travel ranges from several ten

millimeters. To maintain a stable position, the voice-coil linear drive, just as any other linear drive, has to be operated in closed-loop, or alternatively combined with brakes.



Very compact designs are possible with voice-coil linear drives of the PIMag series

## Piezo Drives

### Piezo Actuators

Piezo actuators guarantee position resolutions of less than one nanometer. Several micropositioning stage series can be supplied with additional piezo drives. As an alternative to this serial configuration, they are combined to hybrid drives, that use a common control loop for both motor and piezo actuator.

Piezo actuators can achieve extremely high accelerations of many thousand g, are frictionless and backlash-free. Normally, their travel ranges are limited to less than one millimeter.

### Piezomotors: PiezoWalk®, PLine®, PIShift

Piezomotors do not generate magnetic fields nor are they affected by them. They are used for nanometer-precision-stages with long travel ranges.

Piezomotors are optimally suited for using the specific properties of piezo actuators to achieve longer travel ranges. Adapted to the required

force and velocity development, PI provides a series of different piezomotor technologies, each of which focuses on different features.

#### Piezomotor Properties

- Self-locking when powered off with maximum holding force
- Scalable travel ranges
- Nanometer-precision resolution
- Easy mechanical integration
- Different technologies optimized for high velocities or for high forces

## PI Piezomotors Compared to Piezo Actuators

Piezo flexure or stack actuators	PiezoWalk® piezo stepping drive	PILine® ultrasonic piezomotor	PIShift piezo inertia drive
Sub-nanometer resolution	Sub-nanometer resolution	Sub-micrometer resolution	Sub-nanometer resolution
Fast response within a few microseconds	Velocity up to 10 mm/s High-dynamics scan mode	Very high operating frequency Noiseless drive High velocity of up to several 100 mm/s	Very high operating frequency Noiseless drive Velocity of more than 10 mm/s
Travel ranges of up to approx. 300 µm directly and 2 mm with lever amplification	Long travel ranges, only limited by the runner length	Long travel ranges, only limited by the runner length	Long travel ranges, only limited by the runner length
High stiffness Force generation of up to 100 kN	Very high forces of up to 800 N (NEXLINE®) Self-locking at rest	Forces up to 40 N Self-locking at rest	Forces up to 10 N Self-locking at rest
Control via analog voltage Voltage range 150 V (PICMA® multilayer actuators), 1 100 V (PICA high-load actuators)	Multi-actuator drive generates stepping motion Voltage range 55 V (NEXACT®), 500 V (NEXLINE®)	Single-actuator drive Control via high-frequency alternating voltage (sinus) Voltage range 120 V, 200 V. Mini-motors substantially lower	Single-actuator drive Control via high-frequency alternating voltage (modified sawtooth) Voltage range <48 V
<b>Ideal for:</b>			
<ul style="list-style-type: none"> <li>■ Nanometer-precise positioning with high dynamics</li> <li>■ Lever-amplified and guided systems</li> <li>■ Piezo scanners</li> <li>■ Fine adjustment</li> <li>■ Force generation</li> <li>■ Active vibration insulation</li> </ul>	<ul style="list-style-type: none"> <li>■ Nanometer-precision positioning</li> <li>■ Quasi-static applications at high holding force</li> <li>■ Travel ranges of up to a few mm</li> <li>■ Coarse and fine adjustment</li> <li>■ Force generation</li> <li>■ Active vibration insulation</li> <li>■ Operation at constant, low velocity</li> </ul>	<ul style="list-style-type: none"> <li>■ Positioning with sub-µm accuracy</li> <li>■ Fast step-and-settle</li> <li>■ Scan mode with high velocities</li> <li>■ Operation at constant low, velocity</li> </ul>	<ul style="list-style-type: none"> <li>■ Nanometer-precision positioning stable over a prolonged period</li> <li>■ Quasi-static applications at low to medium holding force</li> </ul>

## Rotating Electric Motors

### DC Motor / Servo Motor

A DC motor with position measurement is called servo motor. The typical characteristics of DC servo motors are uniform, vibration-free operation, a large velocity range and high torques at low velocity. To benefit in a best possible way from these properties, a motor controller with proportional, integral and differential control (PID) and suitable filters is required. The servo motor has numerous advantages, such as good dynamics, fast addressing, high torques at low velocities, reduced heat generation and low vibration.

DC servo motors require an operating voltage of up to 12 VDC. The rotational velocity of the motor is directly proportional to the voltage; the sign determines the direction. Repeatable positioning requires an additional position feedback system.

### Brushless DC Motor

PI uses more and more electronically commutated, brushless DC motors. Optimized hollow shaft or torque motors achieve high torques. At the same time, the drive train can be shorter for the same travel range because the drive shaft is located inside the motor.

## ActiveDrive DC Motors

Some of the advantages of DC motor drives are good dynamic performance with a large control range, high torque at low revolutions, low heat dissipation and low vibration with a high position resolution. The cost of a high-performance linear amplifier, however, is generally higher than that for a stepper motor.

The ActiveDrive system reduces this cost considerably by integrating a PWM (pulse width modulation) driver-amplifier in the motor case. The operating voltage of normally 24 V for ActiveDrive motors is supplied by a separate power supply included in the scope of delivery. The ActiveDrive concept provides several advantages:

- Increased efficiency by eliminating power losses between the amplifier and motor
- Reduced cost, more compact system, and improved reliability, because no external driver and cabling are required
- Elimination of PWM amplifier noise radiation by mounting the amplifier and motor together in a single shielded case

## Stepper Motor Drives

Contrary to DC motors, stepper motor drives only take up discrete positions in a revolution. As these steps have a constant distance, a position may be commanded using the number of steps without any need of a position sensor. Normally, there are 200 to 1000 full steps in each revolution. The actually achievable step width is determined by the stepper motor control, which electronically interpolates up to several hundred thousand microsteps in between the full steps depending on the version. PI uses smoothly running 2-phase stepper motors.

Stepper motors have very long lifetimes and, compared to DC motors, are especially suited for applications with reduced dynamics and in a vacuum. A mechanical damper on the motor shaft, which also works as handwheel, enhances running smoothness.

To maintain a position, stepper motors without self-locking gearhead need to be energized continually. This may cause a position jitter between the steps and generate heat.

## Combinations of Piezo Actuator and Electric Motor

In micropositioning, PI offers combinations of piezo-driven and motorized or manual stages. The motorized drive screw provides long travel ranges, and the additional piezo drive ensures accuracy to the nanometer and fast response behavior. The closed-loop control of such stacked systems works independently using separate position sensors, and the piezo starts to work when the motor stops. The positioning accuracy (not the design resolution) of such a structure is limited by the motorized system. Ideally, this combination is completed by an external control loop.

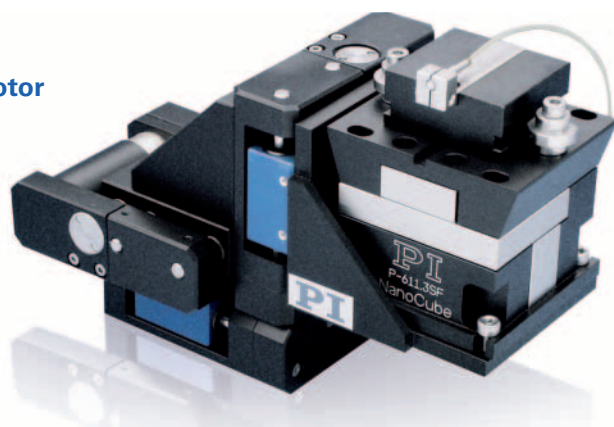

This 3-axis fiber positioning system combines motorized stages for rough positioning over 15 mm with a step width of 50 nm with a fast piezo scanner for fine adjustment over a travel range of 100  $\mu\text{m}$  with 1 nm resolution. The intensity of the light in the fiber determines the optimum position and is used as external control variable

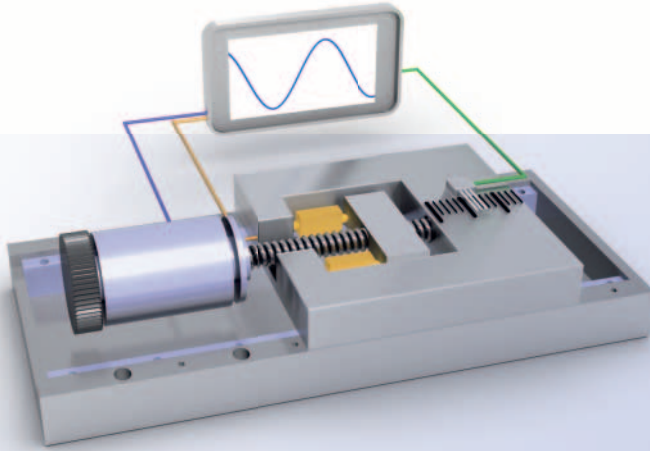

Schematic view of the hybrid drive. The common closed-loop control of the motor (blue) and the piezo actuator (yellow) with a single high-resolution linear encoder (green) allows for extremely constant velocity and high positioning accuracy

### Hybrid Concept with Single Higher-Level Position Measurement and Closed-Loop Control

In hybrid drives, the moving platform is decoupled from the motorized drive train by means of a highly stiff piezo actuator as well as backlash-free and frictionless flexure joints. In positioning mode, settling to a few nanometers only takes a few milliseconds, and minimal increments in the range of the encoder resolution can be reliably executed. In dynamic operation, the piezo actuators guarantee a very constant velocity by compensating the irregularities in the motion of the motorized drive. Stick-slip effects when reaching the position or backlash can so be compensated for.

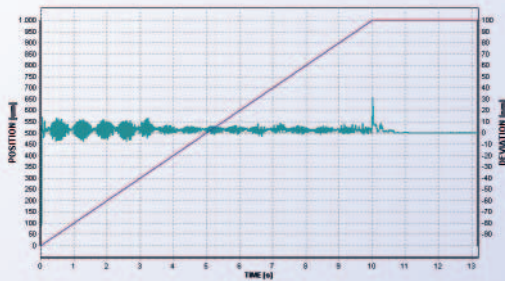

Feed over 1 mm with hybrid stage, velocity 100  $\mu\text{m/s}$ . The deviation from the commanded trajectory is less than 10 nm

The closed-loop control for both motion systems use the same high-resolution position sensor. The result is a motion system with hundreds of millimeters travel but with the precision of a piezo-based nanopositioner. The resolution and the positioning accuracy depend on the choice of the position sensor. PI hybrid systems currently use optical linear encoders with a resolution of 2 nm.

Hybrid stages are particularly suited for applications that need high accuracy for measuring a position and returning to it, or for surface inspection and metrology if you want to reach a target position accurately to the nanometer.

## Drive Train Elements

### Gearhead

Gearheads are used between motor and drive screw; they improve position resolution and torque. Most models use preloaded gearheads to eliminate backlash.

### Leadscrews

Leadscrews can provide very high resolutions and very smooth motion. A leadscrew drive consists of a motor-driven screw with a nut coupled to the moving platform of the stage. The nut can be spring-preloaded to reduce backlash. They have higher friction than recirculating ball screws so that they are self-locking; on the other hand, however, this has an effect on velocity, motor power and lifetime. Typical leadscrews have a pitch between 0.4 and 0.5 mm/revolution, up to 1 mm/revolution for longer travel ranges.

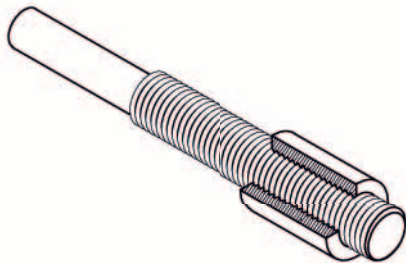

### Recirculating Ball Screws

Recirculating ball screws have significantly less friction than leadscrews because they replace sliding friction with rolling friction.

A recirculating ball screw drive consists of a motor-driven screw with a nut coupled to the moving platform of the stage. Balls in a closed circuit are located between nut (ball case) and drive screw. Backlash can be minimized by selecting the proper ball-to-thread-diameter ratio. Recirculating ball screws are not self-locking but very efficient and offer high velocities and long lifetime in continuous operation. PI uses pitches of 0.5, 1 or 2 mm/revolution.

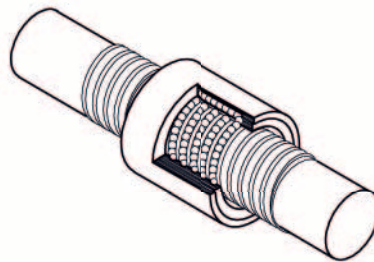

### Threaded Spindle Drives

Threaded spindle drives use rolls instead of balls as rolling bodies so that a higher load rating, higher velocity and considerably longer lifetime are achieved.

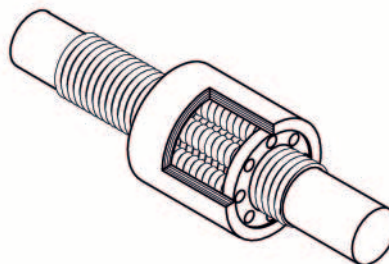

Either rotary or linear optical encoders are used as position feedback sensors.

## Indirect Metrology

Position sensor configuration with indirect measurement of the platform motion. Most often, the sensor is integrated in the drive train, for example, by means of a rotary encoder on the motor shaft. The advantage is an easier attachment of the sensor. Backlash and mechanical play, however, affect the measurement result.

### Rotary Encoder

A rotary encoder is implemented at a rotating point in the drive train, e.g. the motor shaft. To determine the relative position, the controller counts the encoder signals (impulses). To measure an absolute position, a limit switch or reference point switch signal must be used as reference. A typical step width of rotary encoders is approx. 0.1  $\mu\text{m}$ .

## Direct Metrology

Noncontact linear optical encoders measure the actual position with utmost accuracy directly on the moving platform (direct metrology). Errors in the drive train, such as nonlinearity, mechanical play and elastic deformation, are not considered. With linear encoders a resolution down to the nanometer range can be achieved.

## Extended Metrology Concepts

### Absolute Encoders

Absolute encoders deliver additional information about the absolute position of the moving platform.

### Parallel Metrology

Position sensor configuration for multi-axis parallel-kinematic systems, in which all sensors measure the position between base plate and moving platform. It is essential that all motions that differ from the defined trajectory are detected and controlled. This means that position crosstalk of individual axes of all actuators can be compensated ("active trajectory control") which requires highly complex control algorithms.

### Serial Metrology

Position sensor configuration for multi-axis systems, in which some sensors measure the position between two moving platforms. Advantages are an easy integration in a serial-kinematics system and an easy control concept. Guiding errors with position crosstalk of the platforms in between cannot be compensated.

### Tachometer

Tachometers are used for measuring and controlling velocity. Alternatively to a direct measurement, the time course of the position data from the encoder can also be used for velocity control.

## Guidings and Bearings

### Linear Ball Bearing

The balls run in a brass cage and are preloaded with regard to the hardened precision guiding shafts. Exact tolerances between guiding and bearing are necessary for zero backlash and low friction. Load capacity is limited.

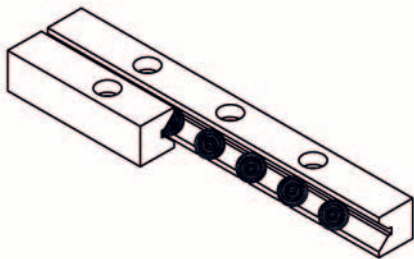

### Crossed Roller Bearings

In crossed roller bearings, the point contact of the balls in ball bearings is replaced by a line contact of the hardened rollers. Consequently, they are considerably stiffer and need less preload so that friction is reduced and a smooth run is possible. Crossed roller bearings are also characterized by high guiding accuracy and high load capacity. Permanent guiding of the rolling body cages avoids migration of the crossed roller bearings.

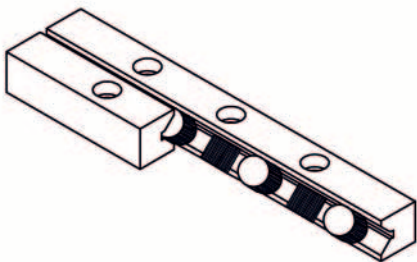

### Recirculating Ball Bearings

High-precision stages are equipped with precision double linear rails. Precision assembly allows these bearings to yield excellent results in terms of load capacity, lifetime, low maintenance and guiding accuracy. The moving part of the stages is supported by a total of four preloaded linear bearings with two rows of recirculating balls each. They are also immune to the cage migration as occur with crossed roller bearings (can be an issue where small ranges are scanned repeatedly).

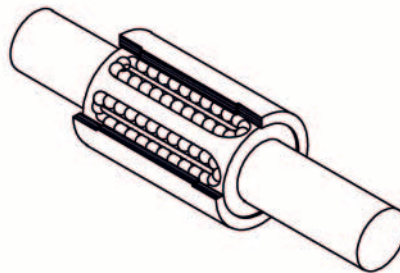

### Air Bearings

An air film of a few micrometers is used as bearing. Therefore, air bearings are friction-free and have a tenfold better guiding accuracy than mechanical bearings. PI miCos uses air bearings in ultra-precision, and high-velocity stages.

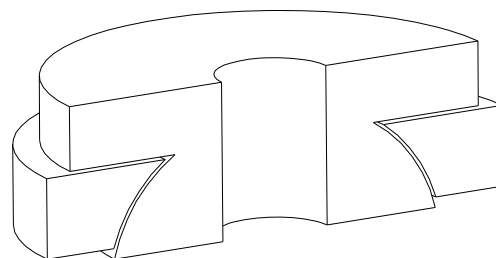

## Magnetic Bearings

Magnetic levitation ensures excellent guiding accuracy in a plane, both linear and rotational: The passive platform levitates on a magnetic field and is actively guided by it. Sequence errors are measured and compensated by very accurate noncontact sensors. Contrary to air bearings, which are also very accurate, magnetic bearings can also be used in vacuum.

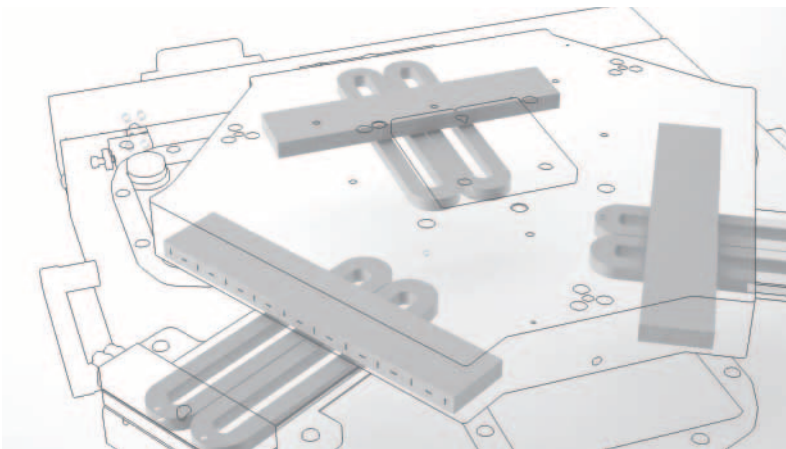

The platform levitates on a magnetic field generated by only six planar coils in the stator

## Flexure Guides

The motion of a flexure joint is based on the elastic deformation of a solid. Therefore, there is no static, rolling or sliding friction. Flexure elements have a high stiffness and load capacity and are very insensitive to shocks and vibrations. Flexure guides are free from maintenance and wear. They are 100% vacuum compatible, function in a wide temperature range and do not require any lubricants.

Flexure guides from PI have proven their worth in nanopositioning. They guide the piezo actuator and ensure a straight motion without tilting or lateral offset. A solid is elastically deformed by a device (flexure) free from static and sliding friction – completely without rolling or sliding parts. This deformation is sufficient to guide the actuator over travel ranges from several 10 to several 100  $\mu\text{m}$ .

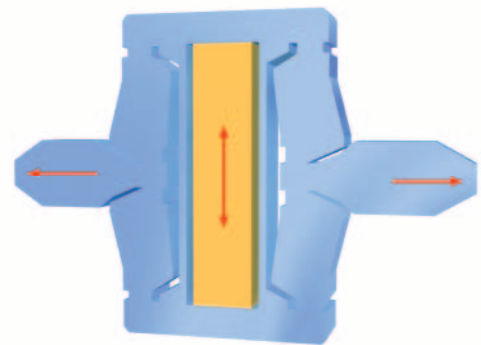

Flexure joints extend the travel range, can re-direct the motion and offer excellent guiding accuracy without friction. The lever mechanism shown above with flexure guides transforms the actuator travel range (vertical) to an even, straight motion (horizontal)



# Use in Vacuum

Almost all stages can be modified for being used in different classes of vacuum. On request, outgassing tests are carried out using a mass spectrometer.

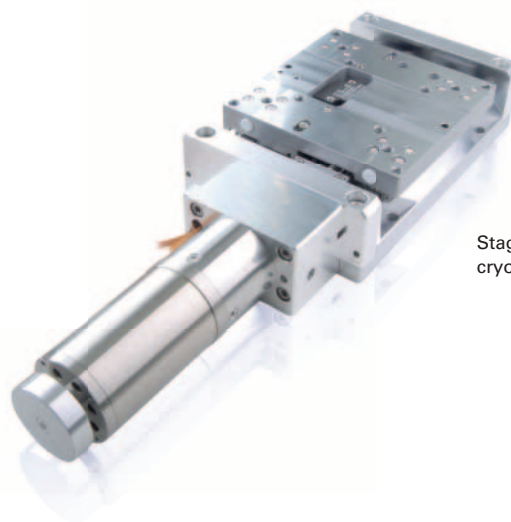

Stage suitable for UHV and cryogenic environment at 77 K

## Vacuum Classification at PI

		Admissible temperature range of the motors	Pressure range
Fine vacuum	FV	-20 to +150°C	up to $1 \times 10^{-3}$ hPa
High vacuum*	HV	-20 to +210°C	$1 \times 10^{-3}$ hPa to $1 \times 10^{-7}$ hPa
Ultrahigh vacuum, no lubricants	UHV	-20 to +210°C	$1 \times 10^{-7}$ hPa to $1 \times 10^{-9}$ hPa
Ultrahigh vacuum, vacuum lubricant	UHV-G	-20 to +210°C	$1 \times 10^{-7}$ hPa to $1 \times 10^{-9}$ hPa
Ultrahigh vacuum, cryogenic range	UHV-C	-269 to +40°C	up to $1 \times 10^{-11}$ hPa
Extremely high vacuum	XHV	-20 to +300°C	$1 \times 10^{-9}$ hPa to $1 \times 10^{-11}$ hPa

1 hPa = 1 mbar

Design and manufacture for ranges beyond these limits are offered on request.

\* A high-vacuum class up to  $1 \times 10^{-6}$  hPa is also usual.

## Decisive: Material Selection

To determine the required vacuum class, it is necessary to know the application well. Crystallography or optical coating, for example, have different requirements not only with regard to the pressure range but also with regard to allowed residual elements in the vacuum chamber. Frequently, the partial pressure of carbon hydrides is decisive. They are part of lubricants and plastics, are released when pumping out the vacuum chamber and can contaminate surfaces. Laser applications in the UV range are particularly sensitive because carbon hydrides are split up and precipitate on the optical system.

For use in HV and UHV, special vacuum lubricants are used. On request, the lubricant may be defined when placing the order. The use of plastics and adhesives is reduced as far as possible.

### Preferred Materials

- Stainless steel
- Aluminum
- Titanium
- Brass
- FPM, e.g. Viton
- Ceramics
- Sapphire
- PTFE, e.g. Teflon
- PEEK
- Polyimide, e.g. Kapton
- Glass ceramics, e.g. Macor

## Mounting in Cleanrooms

Vacuum stages are mounted under cleanroom conditions. All components are cleaned in ultrasound. They are dispatched in an antistatic and particle-free packaging.

## Controllers, Amplifiers and Other Electronic Devices

In general, the control electronics is not suitable for being operated in the vacuum chamber. It has to be mounted outside of the chamber.

### Important Factors for Vacuum Stages

- Low velocity: Maximum 10 revolutions per second
- Short operating time
- Vacuum stages should only be operated in vacuum

If not agreed otherwise, the following applies:

- Bakeout temperature max. 80°C
- Connectors mounted to the stage when being delivered are not intended for use under vacuum conditions. Customers have to replace these test connectors by vacuum connectors
- The vacuum feedthroughs are normally not included in the scope of delivery and may be ordered separately, if required

	FV to 10 <sup>-3</sup> hPa	HV from 10 <sup>-3</sup> to 10 <sup>-7</sup> hPa	UHV from 10 <sup>-7</sup> to 10 <sup>-9</sup> hPa
Motor	- (just as air)	vacuum motor	suitable vacuum motor
Encoder	- (just as air)	modified	modified
Cables	- (just as air)	1 m PTFE (Teflon) cable	1 m PI (Kapton) cable
Limit switches	- (just as air)	- (just as air)	none special UHV limit switches, on request
Surface	anodized (just as air)	not anodized*	not anodized
Screws	stainless steel	stainless steel	stainless steel with silver coating, gas emission bore
Lubrication (guidings, drive train)	vacuum lubricant	vacuum lubricant	UHV: no lubricant UHV-G: vacuum lubricant
Connector	- (just as air)	test connector, not suitable for vacuum	test connector, not suitable for vacuum
Holes	- (just as air)	only through-holes	only through-holes
Other materials	- (just as air)	no CuZn alloys	no CuZn alloys, no plastic
Bakeout temperature	up to 50°C	up to 80°C	up to 120°C, on request up to 150°C

\*For use at up to 10<sup>-6</sup> hPa vacuum stages with black anodized aluminum surface are offered.

# SMC Controller Technology

The control technology of the SMC stepper motor controllers guarantees a particularly smooth running of the motors. The result is a very high position resolution, smooth feed and a large dynamical range of velocity and acceleration. The efficiency of the SMC controllers is very high so that heating of the motors is avoided.

SMC controllers are based on a 32-bit processor combined with high-resolution amplifiers making possible a position resolution down to nanometers. Driving high-precision mechanical systems, uniform feed velocities of less than 1  $\mu\text{m/s}$  can be achieved.

Instead of a linear acceleration profile, you may choose a  $\sin^2$  profile so that smooth, jerk-free acceleration and deceleration phases are possible.

If a stable long-term positioning is required, SMC stepper motor controllers also evaluate position feedback systems for closed-loop control. Processing of an analog 1 V-peak-to-peak value allows you to set the position very accurately and continuously without limitation by a bit-dependent digital transformation.

SMC controllers are available in different versions, from a one-channel compact unit to multi-axis control in 19 inch-case.

## Precision Positioning with the SMC Controller

Figure 1 shows 100 nm steps of a PLS-85 linear stage with 2-phase stepper motor without additional position feedback. The stage carries out these steps very accurately.

When commanding 25 nm steps (see fig. 2), there are more variations in the individual steps. On average, these deviations are  $\pm 5$  nm only.

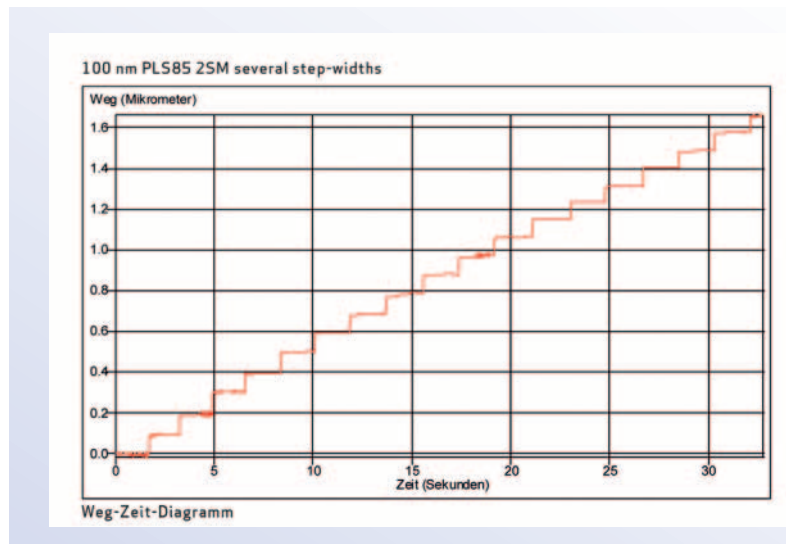

Fig. 1 PLS-85 with 2-phase stepper motor, without position control, 100 nm steps

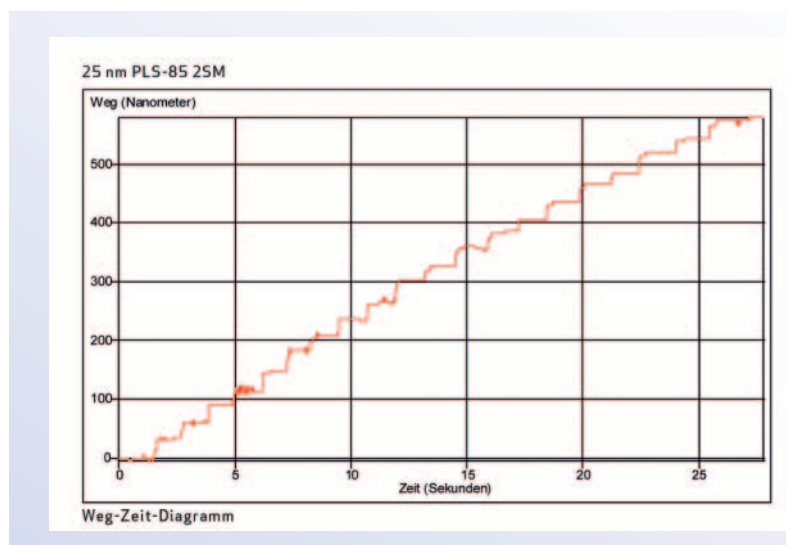

Fig. 2 PLS-85 with 2-phase stepper motor, without position control, 25 nm steps

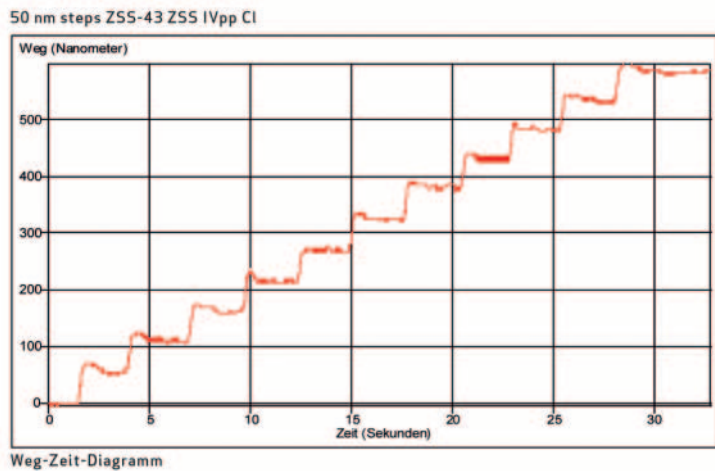

Fig. 3 LS-110 with 2-phase stepper motor in control, 1V-peak-to-peak sensor signal, 50 nm steps

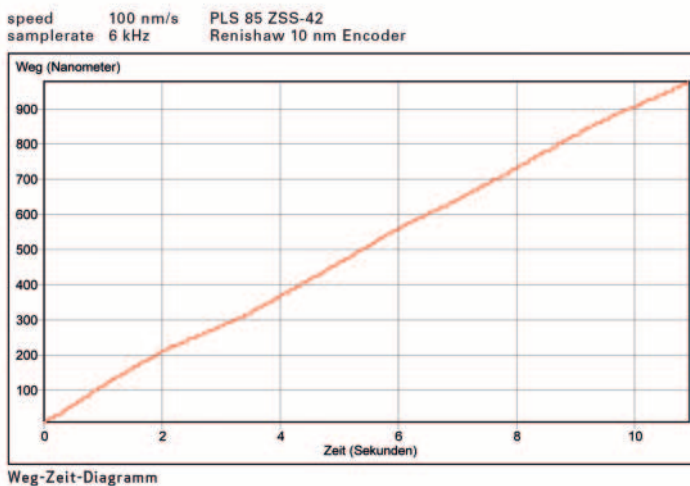

Fig. 4 PLS-85 with 2-phase stepper motor in control, velocity 100 nm/s

## Position Control

The positioning behavior for small steps can be further improved by using position feedback control, in particular, if the analog output signal of a high-resolution sensor is used for processing.

SMC controllers can process sensor resolutions down to 2 nm so that the position resolution only depends on the sensor. However, environmental effects may not be neglected: Variations of ambient temperature by only 0.01°C already cause an expansion of the stage body by approx. 10 nm. If required, ultra-precision stages or specific developments, such as stages with granite base with high-resolution linear encoders, are used.

Figure 3 shows the minimum incremental motion of an LS-110 stage equipped with linear encoder. The 50 nm resolution can be clearly seen with precisely separated steps. Even changes in load do not affect this accuracy.

## Velocity Control

One decisive parameter for selecting a positioning system is velocity. Frequently, the maximum achievable velocity is meant, but some applications require a particularly slow and smooth feed motion. This is a major challenge for both stepper motors and DC motors.

The velocity control of SMC controllers guarantees an excellent stability of the stage velocity of well below 1  $\mu\text{m/s}$ . A higher encoder resolution directly improves the results.

Figure 4 shows the measuring results of a PLS-85 stage with integrated linear encoder with 10 nm resolution. The velocity was set to 100 nm/s, which is a feed of 360  $\mu\text{m}$  per hour or approx. 10 mm per day. The motion is very smooth. The individual steps shown here are due to the interferometer resolution of 5 nm.

## Correcting the Position Error in the Controller

The quality of the guides and the drive train normally limits the positioning accuracy that can be achieved. A nonlinearity of the spindle pitch, for example, causes a deviation from the commanded position.

In some applications, it is important to improve the absolute accuracy while bidirectional repeatability is less relevant. The error correction in the SMC controller saves the measured deviation and then corrects the target position correspondingly.

Figure 5 shows the deviation of  $32\ \mu\text{m}$  between target and actual position of an LS-180 over the travel range of 100 mm. The measurement includes both directions of motion; the bidirectional repeatability is, on average,  $1.78\ \mu\text{m}$ .

The result is shown in Fig. 6: The deviation is considerably smaller, only about  $\pm 1.5\ \mu\text{m}$ . Repeatability may be improved even more by means of position control.

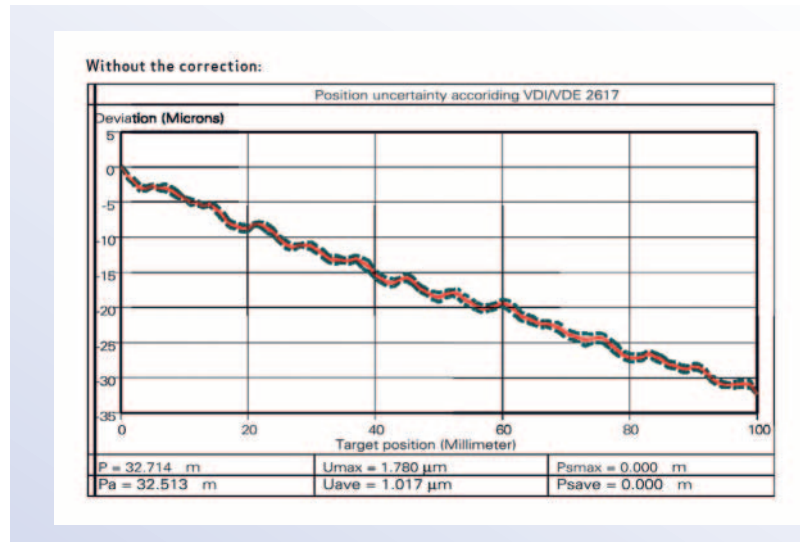

Fig. 5 LS-180 with 2-phase stepper motor, without position control, position measurement

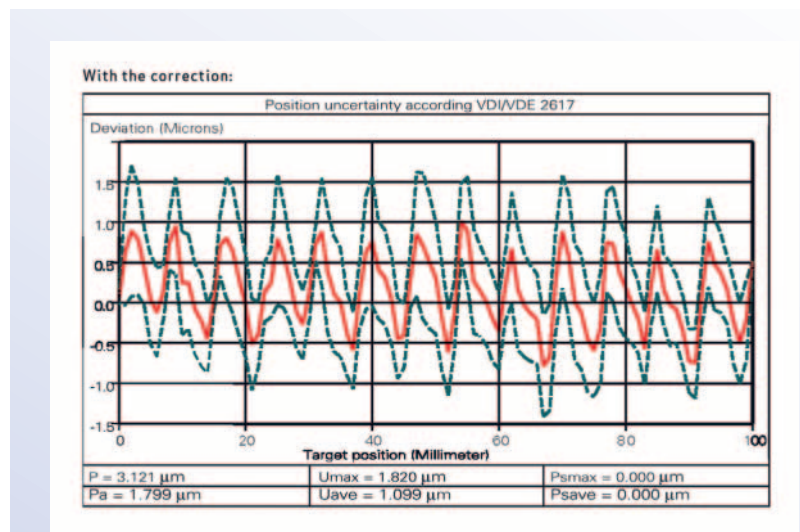

Fig. 6 LS-180 with 2-phase stepper motor, without position control, position measurement with correction

# Glossary

## Absolute accuracy

Absolute accuracy is the maximum difference between the target position and the actual position. Accuracy is limited by backlash, hysteresis, drift, nonlinearity of drive or measurement system, tilt, etc. The best absolute accuracy is achieved with direct metrology sensor systems. In such systems, the position of the platform itself is measured, with, for example, an interferometer or linear encoder so that mechanical play within the drive train does not affect the position measurement. Indirect metrology systems (e.g. rotary encoders on the motor shaft) or open-loop stepper-motor-driven stages, have significantly lower absolute accuracies. Independent of this fact, they can still offer high resolutions and repeatabilities.

## Backlash

The position error that appears upon reversing direction is called backlash. Backlash is caused by mechanical play in the drive train components, such as gearheads or bearings, or by friction in the guiding system. Unlike hysteresis, it can lead to instability in closed-loop setups because it causes a deadband in the control loop. The backlash depends on temperature, acceleration, load, leadscrew position, direction, wear, etc.

Backlash is suppressed by the preload of the drive train. A position measurement method, that can detect the position of the platform directly, eliminates all errors in the drive train (direct metrology).

The data table shows typical measured values. Data for vacuum versions can differ.

## Bidirectional repeatability

The accuracy of returning to a position within the travel range after any change in position. Effects such as hysteresis and backlash affect bidirectional repeatability if the system does not have direct metrology. See also "Unidirectional repeatability".

## Closed-loop operation

A closed-loop operation requires processing the results of a position feedback system. A control algorithm then compares the target position with the measured actual position. The closed-loop control provides a better repeatability and positional stability.

## Cosine error

The cosine error is a cumulative position error in linear systems that occurs when a drive system is misaligned in regard to the driven part. The error is calculated by multiplying the change in position with the difference between 1 and the cosine of the angular error.

## Crosstalk:

### Pitch / yaw, straightness / flatness

Deviation from the ideal straight motion measured along the entire travel range; it is a pitch

around the Y axis and a yaw around the Z axis with the motion being in X direction (orthogonal coordinate system). The data table shows typical measured values as +/- values.

The straightness (in relation to Y) and flatness (in relation to Z) are specified in absolute  $\mu\text{m}$  values.

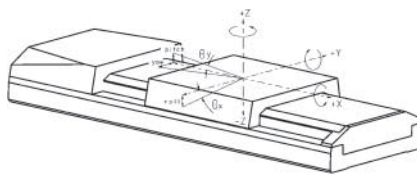

Direction of the axes with linear stages, see also "Guiding accuracy"

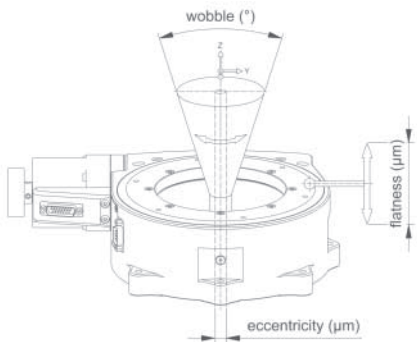

Term definition for rotary stages: Wobble, flatness, eccentricity

## Defining linear and rotational axes

- X: Linear motion in positioning direction
- Y: Linear motion perpendicularly to the X axis
- Z: Linear motion perpendicularly to X and Y
- $\theta_x$ : Rotation around X
- $\theta_y$ : Rotation around Y
- $\theta_z$ : Rotation around Z

## Degree of freedom

A degree of freedom corresponds to an active axis of the positioning system. An XY positioning stage has two degrees of freedom, a Hexapod six.

## Design resolution

The theoretical minimum movement that can be made. Design resolution must not be confused with minimum incremental motion.

In indirect position measurement methods, values for spindle pitch, gear ratio, motor or sensor/encoder resolution, for example, are included in the calculation of the resolution; normally it is considerably below the minimum incremental motion of a mechanical system. In direct measurement methods, the resolution of the sensor system is specified.

## Eccentricity

The deviation between theoretical and actual rotational axis of a rotary stage.

## Guiding accuracy, guiding error

The guiding error represents the deviation of the stage platform from the planned trajectory perpendicularly to the positioning direction and tilt around the axes. For a single-axis linear stage, it is unwanted motion in all five degrees of freedom. For a translation in X, linear runout occurs in Y and Z, tip and tilt occur in X ( $\theta_x$ , roll), Y ( $\theta_y$ , pitch) and Z ( $\theta_z$ , yaw). Guiding errors are caused by the guiding system itself, by the way the stage is mounted (warping) and the load conditions (e.g. torques).

## Holding force, de-energized

Piezomotor linear drives are self-locking at rest, they do not consume current and do not generate heat. If they are switched off for a longer time, the holding force decreases. This is typical for piezomotors. The minimum holding force in long-term operation is specified.

## Hysteresis

Hysteresis is a position error that occurs when reversing direction. It is due to elastic deformation, such as friction-based tension and relaxation. Hysteresis of a positioning system varies greatly with load, acceleration and velocity.

## Lateral force

Maximum permissible force orthogonally to the positioning direction. This value is valid when applied directly to the moving platform, and is reduced when the force applies above the platform.

## Limit switches

Each limit switch sends an overtravel signal on a dedicated line to the controller. The controller then interrupts the motion avoiding that the stage gets damaged when the hard travel stop is reached. PI stages have mechanical, noncontact optical or Hall-effect limit switches.

## Load capacity

Maximum load capacity vertically if the stage is mounted horizontally. The contact point of the load is in the center of the platform.

## Material

Micropositioning stages are normally made of anodized aluminum or stainless steel. Small amounts of other materials may be used (for bearings, preload, coupling, mounting, etc.). On request, other materials, such as nonmagnetic steel or Invar, can be used.

## Max. push / pull force

Maximum force in direction of motion. Some stages may reach higher forces but with limited lifetimes.

## Measured values

Measured values, such as backlash and repeatability, are determined based on the VDI standard 3114.

## Min. incremental motion

The smallest motion that can be repeatedly executed is called minimum incremental motion, or typical resolution, and is determined by measurements. The data table shows typical measured values.

The minimum incremental motion differs in most cases strongly from the "design resolution", which can be considerably smaller in numerical values. Repeatable motions in nanometer and sub-nanometer range can be carried out using piezo stage technology and friction-free flexure guides.

## MTBF

"Mean Time Between Failure". Measure for lifetime and reliability of the stage.

## Open-loop operation

Operation without processing the position sensor and without control loop. Stages with stepper motors execute precise and repeatable steps; therefore, they do not need any closed-loop control. The closed-loop control provides a better repeatability and positional stability.

## Operating temperature range

Safe operation, no damage to the drive. All technical data specified in the data sheet refer to room temperature ( $22 \pm 3^\circ\text{C}$ ).

## Orthogonality

See "Perpendicularity".

## Parallel kinematics

Multi-axis system, in which all actuators act directly on the same moving platform. The advantages if compared to serial kinematics are a lower mass moment of inertia, no moved cables, lower center of gravity, no cumulated guiding errors, more compact structure.

## Perpendicularity, orthogonality

Perpendicularity describes the deviation from an ideal  $90^\circ$  angle of the X, Y and Z motion axes.

## Pitch / yaw

See "Crosstalk".

## Precision

Precision is a term not clearly defined and is used by different manufacturers in different ways for repeatability, accuracy or resolution. PI uses the term for a high, but not quantified, accuracy.

## Pulse width modulation (PWM)

The PWM mode is a highly effective amplifier mode in which the duty cycle is varied rather than the amplitude of the output signal. See "ActiveDrive DC Motors", p. 255

## Reference point switch

Many stages are equipped with direction-sensing reference point switches, which are located at about the midpoint of the travel range. It is recommended to approach the reference point switch always from the same direction to obtain best position repeatability.

## Resolution

See "Design resolution" and "Min. incremental motion".

## Sensor resolution

Rotary encoder: Impulses per screw rotation

Linear encoder: Smallest motion still detected by the sensor system used

## Serial kinematics

Multi-axis system design in which each actuator drives its own separate platform. Advantages are simpler mechanical assembly and control algorithms. Disadvantages compared to parallel kinematics are poorer dynamic performance, no integrated parallel metrology possible, cumulative guiding errors, less accuracy.

## Stick-slip effect, friction

This effect limits the minimum incremental motion. It is produced during the transition from static to sliding friction and causes a motion. Friction-free drives, such as piezo actuators with flexure guides, are not affected by stick-slip effects so that resolutions in the sub-nanometer range are possible.

## Travel range

The maximum possible travel range is limited by the length of the drive screw. The distance between the limit switches, if any, determines the travel range.

## Unidirectional repeatability

The accuracy of returning to a given position from the same direction. Because unidirectional repeatability is almost unaffected by backlash and hysteresis, it is often considerably better than "bidirectional repeatability".

## Velocity, max.

This is the short-term peak value for horizontal mounting, with no load, and not intended for continuous operation. Average and permanent velocities are lower than the peak value and depend on the external conditions of the application. Data for vacuum versions can differ.

## Wobble

Wobble describes tilting of the rotary stages around the rotational axis in each revolution.

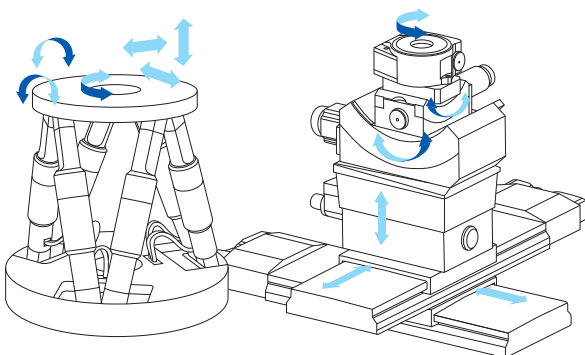

Comparison between parallel-kinematic and serial-kinematic structure of a 6-axis positioner

# Fundamentals of Piezo Technology

---

---

<b>Basic Principles of Piezoelectricity</b>	<b>Page 127</b>
Piezoelectric Effect – Ferroelectric Polarization – Expansion of the Polarized Piezo Ceramic	
<b>Piezoelectric Actuator Materials</b>	<b>Page 128</b>
<b>Displacement Modes of Piezoelectric Actuators</b>	<b>Page 129</b>
<b>Manufacturing of Piezo Actuators</b>	<b>Page 134</b>
Multilayer Tape Technology – Pressing Technology – PTTube Actuators – DuraAct	
<hr/>	
<b>Properties of Piezoelectric Actuators</b>	<b>Page 137</b>
<b>Displacement Behavior</b>	<b>Page 137</b>
Nonlinearity – Hysteresis – Creep – Position Control	
<b>Temperature-Dependent Behavior</b>	<b>Page 140</b>
<b>Forces and Stiffnesses</b>	<b>Page 142</b>
Preload and Load Capacity – Stiffness – Force Generation and Displacement	
<b>Dynamic Operation</b>	<b>Page 146</b>
Resonant Frequency – How Fast Can a Piezo Actuator Expand – Dynamic Forces	
<b>Electrical Operation</b>	<b>Page 147</b>
Electrical Capacitance – Power Consumption – Continuous Operation – Pulse-Mode Operation	
<b>Ambient Conditions</b>	<b>Page 150</b>
Vacuum Environment – Inert Gases – Magnetic Fields – Gamma Radiation – Environments with High Humidity – Liquids	
<b>Reliability of PICMA® Multilayer Actuators</b>	<b>Page 151</b>
Lifetime when Exposed to DC Voltage – Lifetime in Dynamic Continuous Operation	
<hr/>	
<b>Amplifier Technology: Piezo Electronics for Operating Piezo Actuators</b>	<b>Page 153</b>
<b>Characteristic Behavior of Piezo Amplifiers</b>	<b>Page 153</b>
Power Requirements – Amplifier Frequency Response Curve – Setting the Control Input Voltage	
<b>Solutions for High-Dynamics 24/7 Operation</b>	<b>Page 154</b>
Switched Amplifiers with Energy Recovery – Overtemperature Protection – Charge Control	
<hr/>	
<b>Handling of Piezo Actuators</b>	<b>Page 156</b>
Mechanical Installation – Electrical Connection – Safe Operation	

---



# Basic Principles of Piezoelectricity

## The Piezoelectric Effect

Pressure generates charges on the surface of piezoelectric materials. This so-called direct piezoelectric effect, also called the generator or sensor effect, converts mechanical energy to electrical energy. The inverse piezoelectric effect in contrast causes this type of materials to change in length when an electrical voltage is applied. This effect converts electrical energy into mechanical energy and is thus employed in actuator technology.

The piezoelectric effect occurs in monocrystalline materials as well as in polycrystalline ferroelectric ceramics. In single crystals, an asymmetry in the structure of the unit cells of the crystal lattice, i.e. a polar axis that forms below the Curie temperature  $T_c$ , is a sufficient prerequisite for the effect to occur.

Piezoelectric ceramics also have a spontaneous polarization, i.e. the positive and negative charge concentration of the unit cells are separate from each other. At the same time, the axis of the unit cell extends in the direction of the spontaneous polarization and a spontaneous strain occurs (fig. 1).

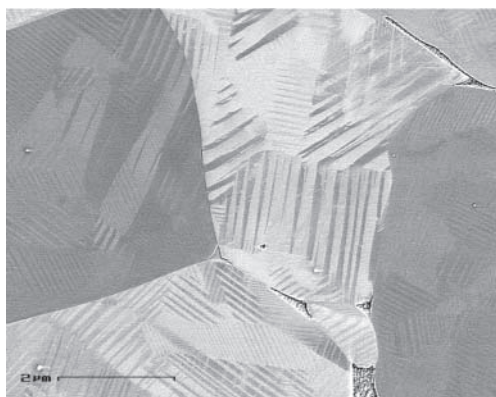

Fig. 2: A cross-sectional view of a ferroelectric ceramic clearly shows the differently polarized domains within the individual crystallites

(Source: Fraunhofer Institute for Ceramic Technologies and Systems IKTS, Dresden, Germany)

## Ferroelectric Polarization

To minimize the internal energy of the material, ferroelectric domains form in the crystallites of the ceramic (fig. 2). Within these volume areas, the orientations of the spontaneous polarization are the same. The different orientations of bordering domains are separated by domain walls. A ferroelectric polarization process is required to make the ceramic macroscopically piezoelectric as well.

For this purpose, a strong electric field of several kV/mm is applied to create an asymmetry in the previously unorganized ceramic compound. The electric field causes a reorientation of the spontaneous polarization. At the same time, domains with a favorable orientation to the polarity field direction grow and those with an unfavorable orientation shrink. The domain walls are shifted in the crystal lattice. After polarization, most of the reorientations are preserved even without the application of an electric field (see fig. 3). However, a small number of the domain walls are shifted back to their original position, e.g. due to internal mechanical stresses.

## Expansion of the Polarized Piezo Ceramic

The ceramic expands, whenever an electric field is applied, which is less strong than the original polarization field. Part of this effect is due to the piezoelectric shift of the ions in the crystal lattice and is called the intrinsic effect.

The extrinsic effect is based on a reversible ferroelectric reorientation of the unit cells. It increases along with the strength of the driving field and is responsible for most of the nonlinear hysteresis and drift characteristics of ferroelectric piezoceramics.

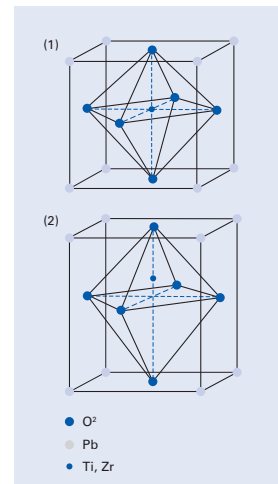

Fig. 1  
(1) Unit cell with symmetrical, cubic structure above the Curie temperature  $T_c$   
(2) Tetragonally distorted unit cell below the Curie temperature  $T_c$  with spontaneous polarization and spontaneous strain

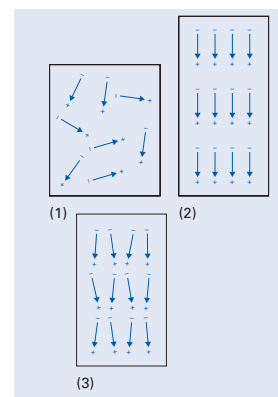

Fig. 3  
Orientation of the spontaneous polarization within a piezo ferroelectric ceramic  
(1) Unpolarized ceramic, (2) Ceramic during polarization and (3) ceramic after polarization

# Piezoelectric Actuator Materials

## Basic Principles of Piezoelectricity

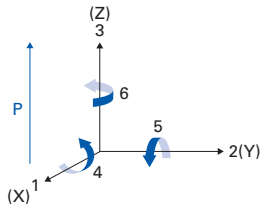

Fig. 4  
Orthogonal system to describe the properties of a polarized piezo ceramic. Axis 3 is the direction of polarization

Commercially available piezoceramic materials are mostly based on the lead-zirconate-lead-titanate material system (PZT). By adding other materials the properties of the PZT compositions can be influenced.

Ferroelectrically soft piezoceramics with low polarity reversal field strengths are used for actuator applications since the extrinsic domain contributions lead to high overall piezo moduli. This includes the piezoceramics PIC151, PIC153, PIC255, PIC252 and PIC251.

Ferroelectrically hard PZT materials, such as PIC181 and PIC300, are primarily used in high-power ultrasound applications. They have a higher polarity reversal resistance, high mechanical quality factors as well as low hysteresis values at reduced piezoelectric deformation coefficients. The Picoactuator® series is based on the monocrystalline material PIC050, which has a highly linear, hysteresis-free characteristic, but with small piezoelectric coefficients.

### Actuator Materials from PI Ceramic

**PIC151** Modified PZT ceramic with balanced actuator characteristics. High piezoelectric coupling, average permittivity, relatively high Curie temperature.

Standard material for the PICA Stack, PICA Thru and PT Tube product lines.

**PIC153** Modified PZT ceramic for large displacements.

High piezoelectric deformation coefficients, high permittivity, relatively low Curie temperature.

Special material for the PICA Stack and PICA Thru product lines as well as for glued bending actuators.

**PIC255** Modified PZT ceramic that is especially suited to bipolar operation, in shear actuators, or with high ambient temperatures.

High polarity reversal field strength (>1kV/mm), high Curie temperature. Standard material for the PICA Power, PICA Shear, PT Tube and DuraAct product lines

**PIC252** Variant of the PIC255 material with a lower sintering temperature for use in the multilayer tape process.

Standard material for the PICMA® Stack, PICMA® Chip and PICMA® Bender product lines as well as some DuraAct products.

**PIC050** Crystalline material for linear, hysteresis-free positioning with small displacements in an open servo loop.

Excellent stability, high Curie temperature.

Standard material for the Picoactuator® product line.

	PIC151	PIC153	PIC255/252	PIC050
Density $\rho$ [g/cm <sup>3</sup> ]	7.80	7.60	7.80	4.70
Curie temperature $T_c$ [°C]	250	185	350	>500
Relative permittivity in polarization direction $\epsilon_{33}^T/\epsilon_0$	2400	4200	1750	60
perpendicular to polarization $\epsilon_{11}/\epsilon_0$	1980		1650	85
Dielectric loss factor $\tan \delta$ [10 <sup>-3</sup> ]	20	30	20	<1

### Physical and Dielectric Properties

### Electro-Mechanical Properties

Piezoelectric deformation coefficient, piezo modulus*	PIC151	PIC153	PIC255/252	PIC050
$d_{31}$ [pm/V]	-210		-180	
$d_{33}$ [pm/V]	500	600	400	40
$d_{15}$ [pm/V]			550	80

### Acousto-Mechanical Properties

Elastic compliance coefficient	PIC151	PIC153	PIC255/252	PIC050
$s_{11}^E$ [10 <sup>-12</sup> m <sup>2</sup> /N]	15.0			16.1
$s_{33}^E$ [10 <sup>-12</sup> m <sup>2</sup> /N]	19.0			20.7
Mechanical quality factor $Q_m$		100	50	80

For explanations and further data, see the catalog "Piezoceramic Materials and Components"  
\*The deformation coefficient corresponds to the charge coefficient used with piezo components. The value depends on the strength of the driving field (fig. 22, p. 137). The information in the table refers to very small field strengths (small signal)

PI Ceramic offers a wide range of further materials, including lead-free piezoceramics that are currently mainly used as ultrasonic transducers.

For application-specific properties, actuators can be manufactured from special materials, although the technical implementation has to be individually checked. [www.piceramic.com](http://www.piceramic.com)

# Displacement Modes of Piezoelectric Actuators

## Basic Principles of Piezoelectricity

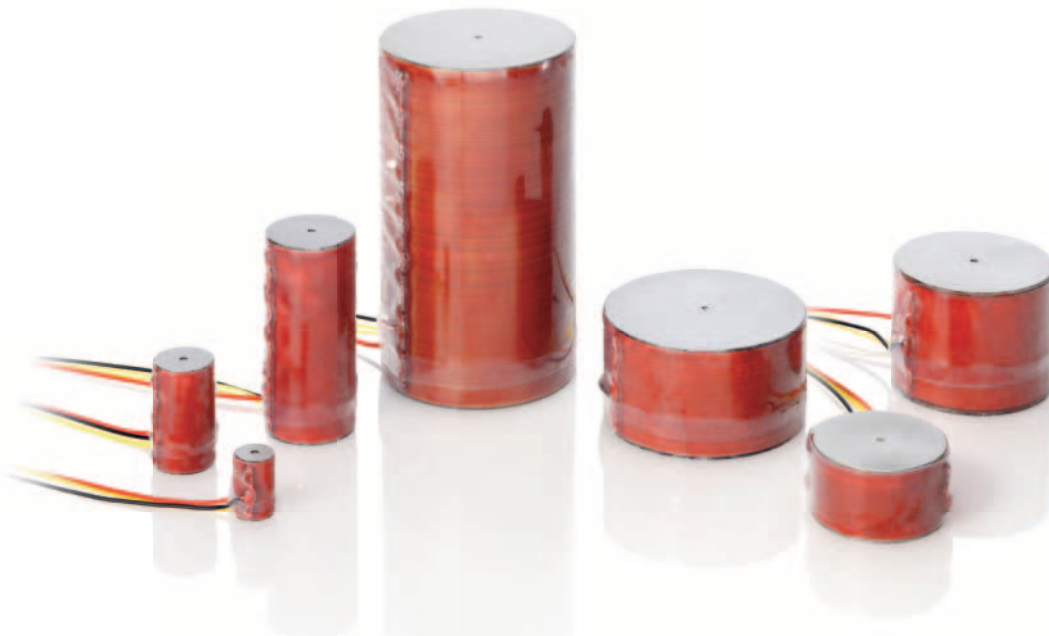

Examples of longitudinal stack actuators are the multilayer piezo actuators PICMA® Stack, Encapsulated PICMA®, PICMA® Chip, as well as the stacked actuators PICA Stack, PICA Power, PICA Thru that are glued together from individual plates, and the crystalline Picoactuator®.

### Longitudinal Stack Actuators

In longitudinal piezo actuators, the electric field in the ceramic layer is applied parallel to the direction of polarization. This induces an expansion or displacement in the direction of polarization. Individual layers provide relatively low displacements. In order to achieve technically useful displacement values, stack actuators are constructed, where many individual layers are mechanically connected in series and electrically connected in parallel (fig. 5).

Longitudinal stack actuators are highly efficient in converting electrical to mechanical energy. They achieve nominal displacements of around 0.1 to 0.15% of the actuator length. The nominal blocking forces are on the order of

30 N/mm<sup>2</sup> in relation to the cross-sectional area of the actuator. Values of up to several 10000 Newton can thus be achieved in the actuator.

Longitudinal stack actuators are excellently suited for highly dynamic operation due to their high resonant frequencies. A mechanical preloading of the actuator suppresses dynamically induced tensile forces in brittle ceramic material, allowing response times in the microsecond range and a high mechanical performance.

$\Delta L_{long}$	Longitudinal displacement [m]
$d_{33(GS)}$	Longitudinal piezoelectric large-signal deformation coefficient [m/V]
$n$	Number of stacked ceramic layers
$V$	Operating voltage [V]

In addition to the expansion in the direction of polarization, which is utilized with longitudinal actuators, a contraction always occurs in the piezo actuator that is orthogonal to its polarization when it is operated with an electric field parallel to the direction of polarization.

This so-called transversal piezoelectric effect is used by contracting actuators, tube actuators, or bending actuators.

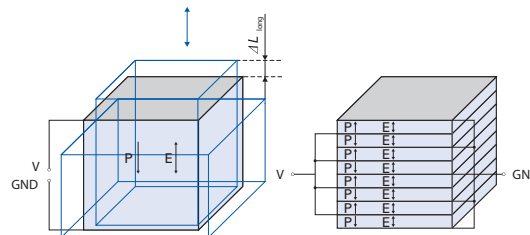

Fig. 5  
 $\Delta L_{long} = n d_{33(GS)} V$  (Equation 1)

A typical application for shear actuators are drive elements for so-called stick-slip motors.

Shear actuators from PI Ceramic are offered as product lines PICA Shear und Picoactuator®.

### Shear Actuators

In piezoelectric shear actuators, the electric field in the ceramic layer is applied orthogonally to the direction of polarization and the displacement in the direction of polarization is utilized. The displacements of the individual layers add up in stacked actuators here as well (fig. 6).

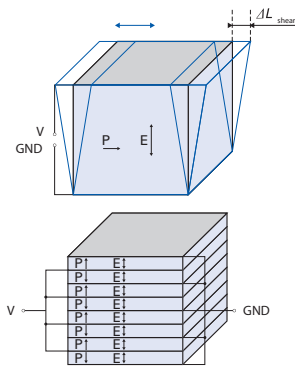

Fig. 6  
 $\Delta L_{shear} = n d_{15(GS)} V$

(Equation 2)



Furthermore, shear stresses cannot be compensated by a mechanical preload. Both, limit the practical stacking height of shear stacks.

Shear actuators combined with longitudinal actuators yield very compact XYZ stacks with high resonant frequencies.

### Picoactuator® Technology

Picoactuator® longitudinal and shear actuators are made of the crystalline piezoelectric material PIC 050. The specific displacement is  $\pm 0.02\%$  (shear actuators) or  $\pm 0.01\%$  (longitudinal piezo actuators) of the actuator length and is thus 10 times lower than for classic piezo actuators made of lead zirconate - lead titanate (PZT). The displacement here is highly linear with a deviation of only 0.2%.

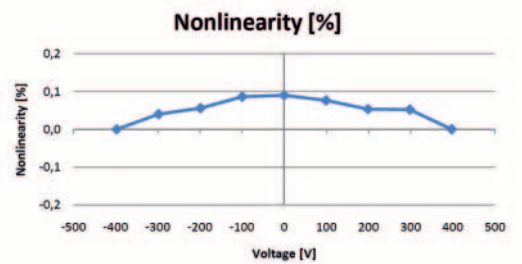

Fig. 7:  
 Measured nonlinearity of a Picoactuator®



## Tube Actuators

Tube actuators are radially polarized. The electrodes are applied on the outer surfaces, so that the field parallel to the polarization also runs in a radial direction. Tube actuators use the transversal piezoelectric effect to generate displacements. Axial displacements or changes in length (fig. 8), lateral motions such as changes in the radius (fig. 9), as well as bending (fig. 10) are possible.

In order to cause a tube to bend, the outer electrode is segmented into several sections. When the respectively opposite electrodes are driven, the tube bends in a lateral direction.

Undesirable tilting or axial motions that occur during this process can be prevented by more complex electrode arrangements. For example, an eight-electrode arrangement creates a counter bending and overall achieves a lateral displacement without tilting.

PI Ceramic offers precision tube actuators in the PTTube product line.



### Axial displacement

$$\Delta L_{axial} = d_{31(GS)} \frac{l}{t} V$$

(Equation 3)

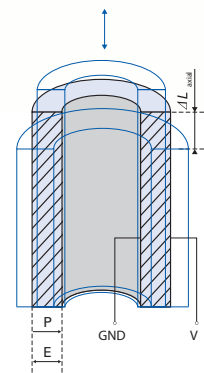

Fig. 8

### Radial displacement (radius change)

The following estimation applies for large radii:

$$\Delta L_{radial} \approx d_{31(GS)} \frac{ID}{2t} V$$

(Equation 4)

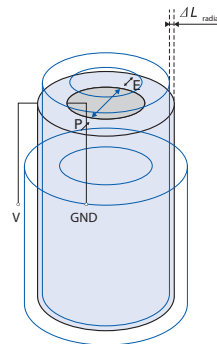

Fig. 9

### Bending actuators, XY scanning tubes

$$\Delta L_{lateral} = 0.9 d_{31(GS)} \frac{l^2}{ID} V$$

(Equation 5)

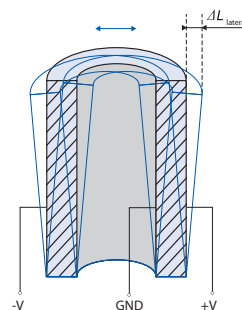

Fig. 10

$\Delta L_{shear}$	Shear displacement [m]
$d_{15(GS)}$	Piezoelectric large-signal shear deformation coefficient [m/V]
$n$	Number of stacked ceramic layers
$V$	Operating voltage [V]
$\Delta L_{axial}$	Axial tube displacement [m]
$\Delta L_{radial}$	Radial tube displacement [m]
$\Delta L_{lateral}$	Lateral tube displacement [m]
$d_{31(GS)}$	Transversal piezoelectric large-signal deformation coefficient [m/V]
$l$	Tube length [m]
$ID$	Internal tube diameter [m]
$t$	Tube wall thickness (= (OD-ID)/2) [m]
All tube dimensions, see data sheet	

Tube actuators are often used in scanning probe microscopes to provide dynamic scanning motions in open-loop operation, and as fiber stretchers.

Further application examples are microdosing in the construction of nanoliter pumps or in inkjet printers.

$\Delta L_{trans}$	Transversal displacement [m]
$d_{31(GS)}$	Transversal piezoelectric large-signal deformation coefficient [m/V]
$l$	Length of the piezo ceramic in the direction of displacement [m]
$h$	Height of a ceramic layer [m]
$n$	Number of stacked ceramic layers
$V$	Operating voltage [V]
$\Delta L_{bend}$	Bending displacement [m]
$l_f$	Free bender length [m]
$h_p$	Height piezo-ceramic element [m]
$R_h$	Ratio of the heights of the substrate ( $h_s$ ) and piezoceramic element ( $h_p$ ) in a composite bender ( $R_h = h_s/h_p$ )
$R_E$	Ratio of the elasticity modulus of the substrate ( $E_s$ ) and the piezo-ceramic element ( $E_p$ ) in a composite bender ( $R_E = E_s/E_p$ )
$V_F$	Fixed voltage for bender actuator control [V] ( $V$ and $V_F$ can be superimposed with an offset voltage)

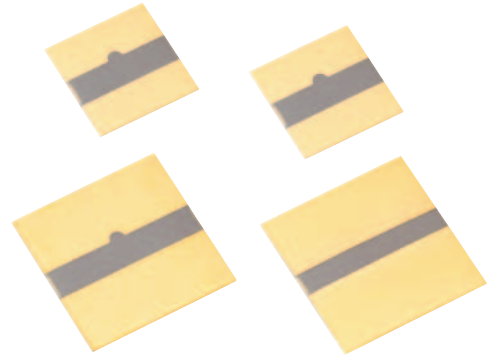
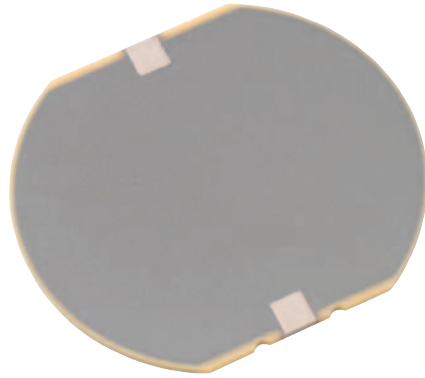

### Contracting Actuators

Typically, piezo contracting actuators are low-profile components. Their displacement occurs perpendicularly to the polarization direction and to the electric field. The displacement of contracting actuators is based on the transversal piezoelectric effect whereby up to approx. 20  $\mu\text{m}$  is nominally achieved.

Multilayer elements offer decisive advantages over single-layer piezo elements in regard to technical realization: Due to the larger cross-sectional area, they generate higher forces and can be operated with a lower voltage (fig. 11).

As a result of the contraction, tensile stresses occur that can cause damage to the brittle piezo ceramic. A preload is therefore recommended.

For the patch actuators of the DuraAct product group, a piezo contractor is laminated into a polymer. This creates a mechanical preload that protects the ceramic against breakage.

Multilayer contracting actuators can be requested as special versions of the PICMA® Bender product line.

Fig. 11

$$\Delta L_{trans} = d_{31(GS)} \frac{l}{h} V \quad (\text{Equation 6})$$

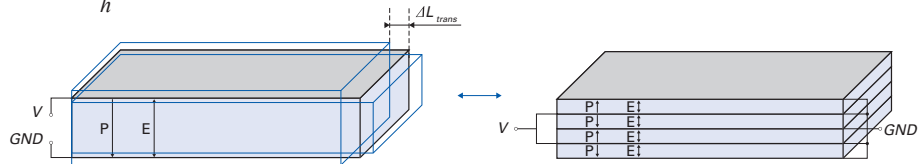

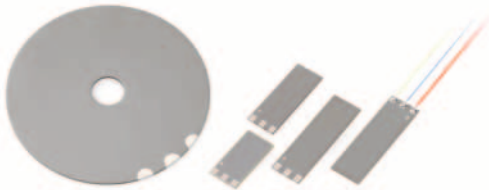

### Bending Actuators

Attached to a substrate, contracting actuators act as bending actuators (fig. 12). For the construction of all-ceramic benders, two active piezoceramic elements are joined and electrically controlled. If a passive substrate made of metal or ceramic material, for example, is used, one speaks of composite benders. The piezoceramic elements can be designed as individual layers or as multilayer elements.

Piezoelectric bending actuators function according to the principle of thermostatic bimetals. When a flat piezo contracting actuator is coupled to a substrate, the driving and contraction of the ceramic creates a bending moment that converts the small transversal

change in length into a large bending displacement vertical to the contraction. Depending on the geometry, translation factors of 30 to 40 are attainable, although at the cost of the conversion efficiency and the force generation.

With piezoelectric bending actuators, displacements of up to several millimeters can be achieved with response times in the millisecond range. The blocking forces, however, are relatively low. They are typically in the range of millinewtons to a few newtons.

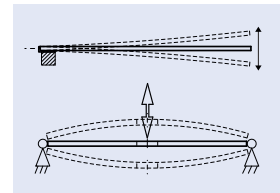

Fig. 17  
By selecting a two-sided restraint with a rotatable mounting (bottom) instead of a single-sided fixed restraint (top), the ratio of the displacement and the force of the bender can be changed. The displacement is reduced by a factor of four while the blocking force is increased by a factor of four. Especially high forces can be attained when using flat bending plates or disks with a restraint on two sides instead of strip-shaped benders

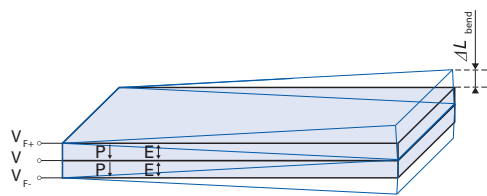

Fig. 12: Displacement of bending actuators

### All-ceramic bending actuator for parallel circuiting

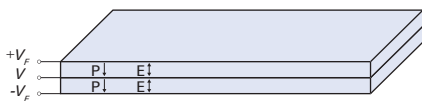

Fig. 13

$$\Delta L_{bend} = \frac{3}{8} n d \frac{l_f^2}{h_p^2} V \quad (\text{Equation 7})$$

### All-ceramic bending actuator for serial circuiting

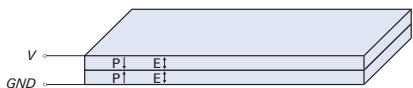

Fig. 14

$$\Delta L_{bend} = \frac{3}{8} n d_{31(GS)} \frac{l_f^2}{h_p^2} V \quad (\text{Equation 8})$$

(Operation against the polarization direction only possible with reduced voltage or field strength, p. 137ff.)

### Two-layer composite bender with one-sided displacement

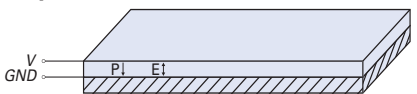

Fig. 15

$$\Delta L_{bend} = \frac{3}{8} n d_{31(GS)} \frac{l_f^2}{h_p^2} \frac{2R_h R_E (I + R_h)}{R_h R_E (I + R_h)^2 + 0.25(I - R_h^2 R_E)^2} V$$

(Equation 9)  
Application DuraAct, PICMA® Bender (customized versions)

### Symmetrical three-layer composite bender for parallel circuiting

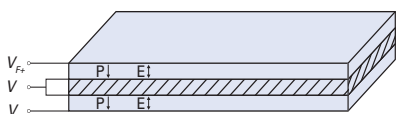

Fig. 16

$$\Delta L_{bend} = \frac{3}{8} n d_{31(GS)} \frac{l_f^2}{h_p^2} \frac{I + R_h}{I + 1.5R_h + 0.75R_h^2 + 0.125R_E R_h^3} V$$

(Equation 10)

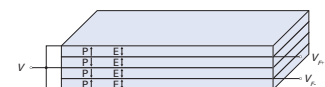
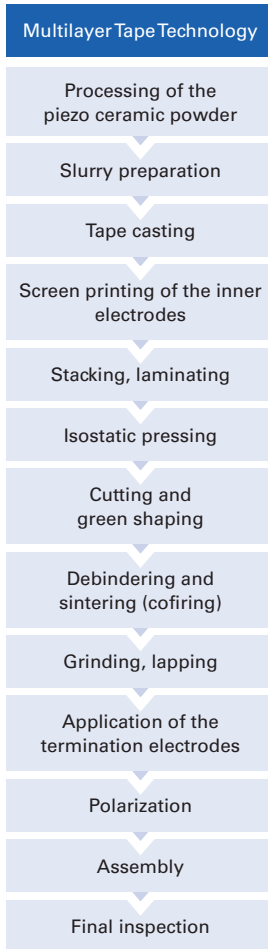

Fig. 18:  
The products of the PICMA® Bender line are all-ceramic bending actuators with two piezoceramic elements that each consist of several active layers (multilayer actuators)

Equations according to Pfeifer, G.: Piezoelektrische lineare Stellantriebe. Scientific journal series of Chemnitz University of Technology 6/1982

# Manufacturing of Piezo Actuators

## Basic Principles of Piezoelectricity



### Multilayer Tape Technology

The technologies for manufacturing piezo actuators decisively contribute to their function, quality and efficiency. PI Ceramic is proficient in a wide range of technologies, from multilayer tape technology for PICMA® stack and bending actuators, through glued stack actuators for longitudinal and shear displacements, up to the construction of crystalline Picoactuator® actuators, the DuraAct patch transducers and piezoceramic tubes.

PI Ceramic multilayer actuators, PICMA® for short, are manufactured in large batches with tape technology. First, the inner electrode pattern is printed on thin PZT tapes while still unsintered and these are then laminated into a multilayer compound. In the subsequent cofiring process, the ceramic and the inner electrodes are sintered together. The finished monolithic multilayer piezo element has no polymer content anymore.

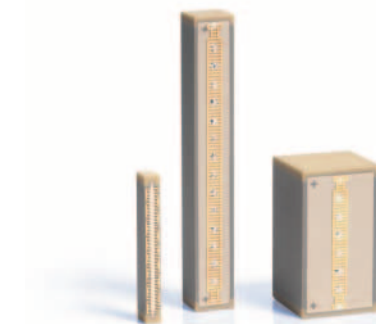
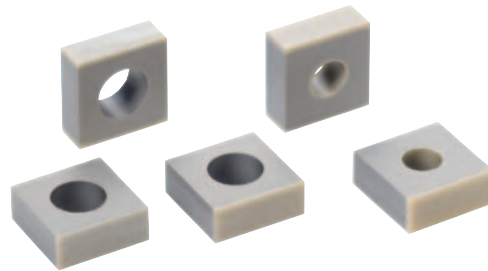

The inner electrodes of all PICMA® actuators are ceramically insulated (fig. 19). PICMA® Stack actuators use a patented structure for this purpose, in which a thin ceramic insulation tape covers the electrodes without significantly limiting the displacement.

The more fine-grained the ceramic material used, the thinner the multiple layers that can be produced. In PICMA® Stack actuators, the height of the active layers is 60 µm and in PICMA® Bender actuators around 20 to 30 µm, so that the benders can be operated with a very low nominal voltage of only 60 V.



Hermetically encapsulated PICMA® were developed for applications in extremely high humidity and in rough industrial environments. They are equipped with corrosion-resistant stainless-steel bellows, inert gas filling, glass feedthroughs and laser welding

In the past years, the technologies for processing actuators in an unsintered state have been continuously developed. For this reason, round geometries or PICMA® actuators with an inner hole can also be manufactured

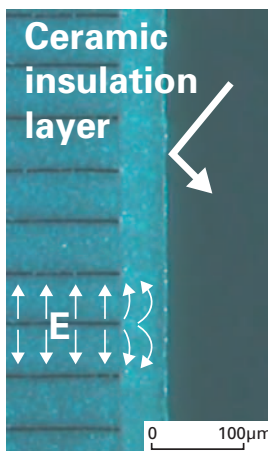
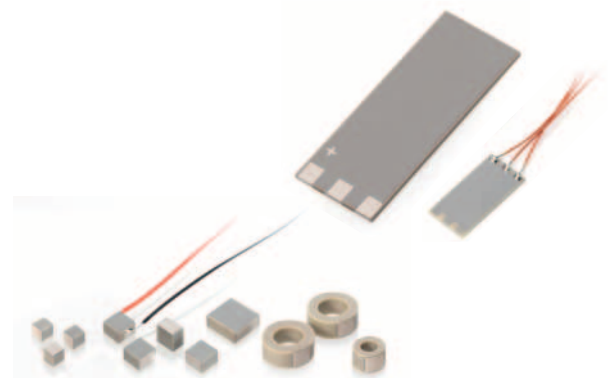

Fig. 19:  
In PICMA® stack actuators, a ceramic insulation tape covers the inner electrodes



PICMA® multilayer actuators are produced in different shapes. Depending on the application, they can also be assembled with adapted ceramic or metal end pieces, additional coating, temperature sensors, etc.



## Pressing Technology

PICA stack actuators such as PICA Stack, Thru or Shear consist of thin piezoceramic plates with a standard layer thickness of 0.5 mm. For manufacturing, piezoceramic cylinders or blocks are shaped with pressing technology, sintered and then separated into plates with diamond wafer saws. Metal electrodes are attached with thin or thick film methods depending on the material, and the ceramic is then polarized.

Stack actuators are created by gluing the plates together whereby a thin metal contact plate is placed between each two ceramic plates in order to contact the attached electrodes. The contact plates are connected with each other in a soldering step, and the finished stack is then covered with a protective polymer layer and possibly an additional shrink tubing.

Picoactuator® piezo actuators consist of crystalline layers with a thickness of 0.38 mm. In contrast to ceramic, the orientation of the spontaneous polarization is not determined by a ferroelectric polarization but by the cutting direction in the monocrystal. All other processing and mounting steps are similar to those for stacked PICA actuators.

Completely assembled stack actuators with a metal endpiece and SGS expansion sensor (left), with stranded wires, temperature sensor and transparent FEP shrink tubing (right)

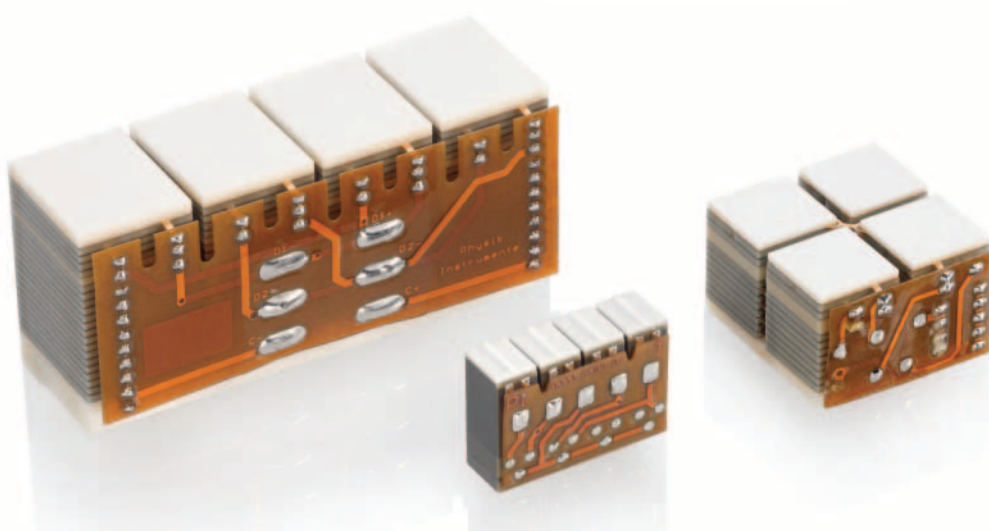

The final processing of the piezoceramic plates manufactured with pressing technology is adapted to their future use. The figure shows different piezo actuator modules



Structured electrodes allow specific driving of tube actuators

### PT Tube Actuators

PT Tube actuators are manufactured from piezoceramic cylinders that were previously produced with the pressing technology. The outer diameter and the parallelism of the end-surface are precisely set through centerless circular grinding and surface grinding. The inner hole is drilled with an ultrasonic method.

The metalization then is done with thin- or thick-layer electrodes, possibly accompanied by structuring of the electrodes with a laser ablation method.

In addition to the described procedure for manufacturing precision tubes with very narrow geometric tolerances, the more cost-efficient extrusion method is also available for small diameters.

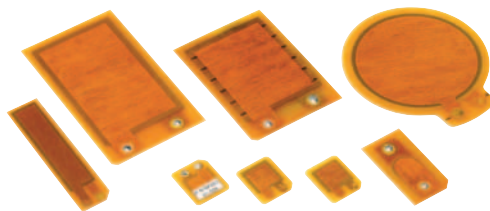

Different shapes of DuraAct actuators with ceramic plates in pressing and multilayer technology

### DuraAct Patch Actuators and Transducers

DuraAct patch actuators use piezoceramic contracting plates as their base product. Depending on the piezoceramic thickness, these plates are manufactured with pressing technology (>0.2 mm) or tape technology (0.05 to 0.2 mm). The plates are connected to form a composite using conductive fabric layers, positioning tapes, and polyimide cover tapes.

The lamination process is done in an autoclave in a vacuum, using an injection method. This results in completely bubble-free laminates of the highest quality.

The curing temperature profile of the autoclave is selected so that a defined internal preload of the piezoceramic plates will result due to the different thermal expansion coefficients of the materials involved.

The result of this patented technology are robust, bendable transducer elements that can be manufactured in large batches.

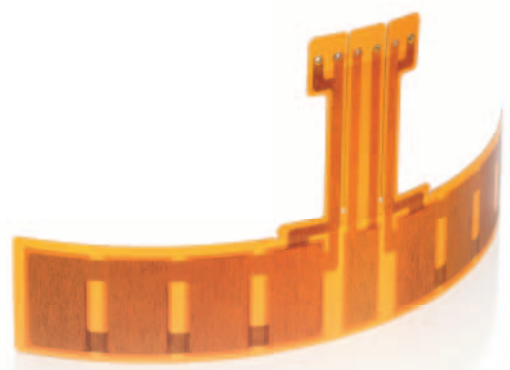

Laminated ceramic layers in a DuraAct transducer arrangement (array)

# Properties of Piezoelectric Actuators

## Displacement Behavior

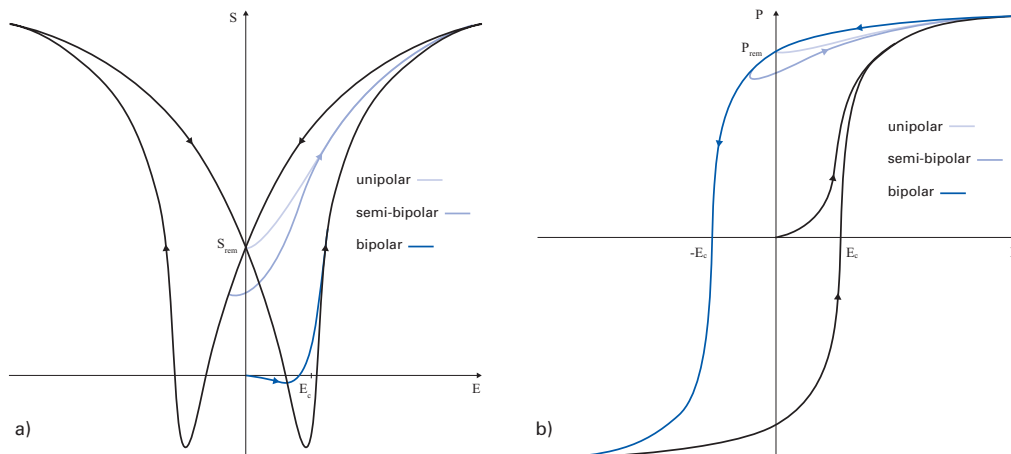

Fig. 20: Displacement of ferroelectric piezo ceramics with different control amplitudes parallel to the direction of polarization direction. Large-signal curves as a function of the electrical field strength E a) electromechanical behavior of the longitudinal strain S, b) dielectric behavior of the polarization P

### Nonlinearity

The voltage-dependent displacement curves of piezo actuators have a strongly nonlinear course that is subject to hysteresis due to the extrinsic domain contributions. It is therefore

not possible to interpolate linearly from the nominal displacement to intermediate positions with a particular driving voltage. The electromechanical and dielectric large-signal curves of piezo ceramics illustrate the characteristics (fig. 20). The origin of each graph is defined by the respective thermally depolarized condition.

The shape of both bipolar large-signal curves is determined by the ferroelectric polarity reversal process when the coercive field strength  $E_c$  is achieved in the opposing field. The dielectric curve shows the very large polarization changes at these switchover points. At the same time, the contraction of the ceramic after reversing the polarity turns into an expansion again, since the polarization and the field strength have the same orientation once more. This property gives the electromechanical curve its characteristic butterfly shape. Without the electric field, the remnant polarizations  $P_{rem} / -P_{rem}$  and the remnant strain  $S_{rem}$  remain.

Piezo actuators are usually driven unipolarly. A semi-bipolar operation increases the strain amplitude while causing a stronger nonlinearity and hysteresis which result from the increasing extrinsic domain portions of the displacement signal (fig. 21).

In the PI and PIC data sheets, the free displacements of the actuators are given at nominal voltage.

### Piezoelectric Deformation Coefficient (Piezo Modulus)

The gradient  $\Delta S / \Delta E$  between the two switchover points of the nonlinear hysteresis curves is defined as the piezoelectric large-signal deformation coefficients  $d_{(GS)}$  (fig. 21). As the progressive course of the curves shows, these coefficients normally increase along with the field amplitude (fig. 22).

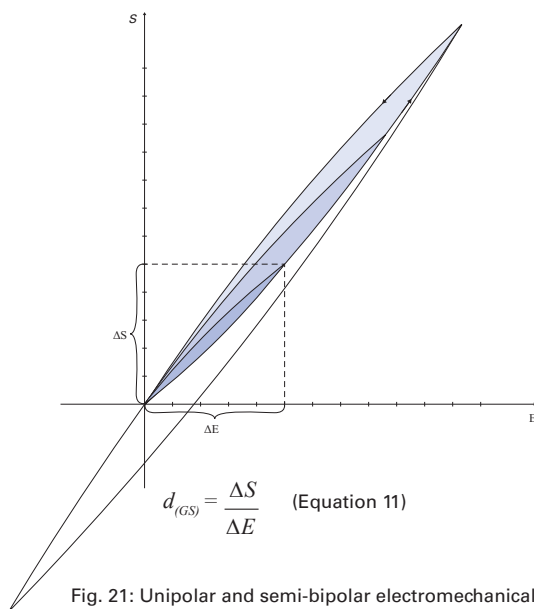

Fig. 21: Unipolar and semi-bipolar electromechanical curves of ferroelectric piezo ceramics and definition of the piezoelectric large-signal deformation coefficient  $d_{(GS)}$  as the slope between the switchover points of a partial hysteresis curve

$$d_{(GS)} = \frac{\Delta S}{\Delta E} \quad (\text{Equation 11})$$

### Estimation of the Expected Displacement

If the values from fig. 22 are entered into the equations 3 to 10 (p. 131-133), the attainable displacement at a particular piezo voltage can be estimated. The field strength can be calculated from the layer heights of the specific component and the drive voltage  $V_{PP}$ . The layer thickness of the PI Ceramic standard products can be found starting on p. 134.

The free displacement of the components that can actually be attained depends on further factors such as the mechanical preload, the temperature, the control frequency, the dimensions, and the amount of passive material.

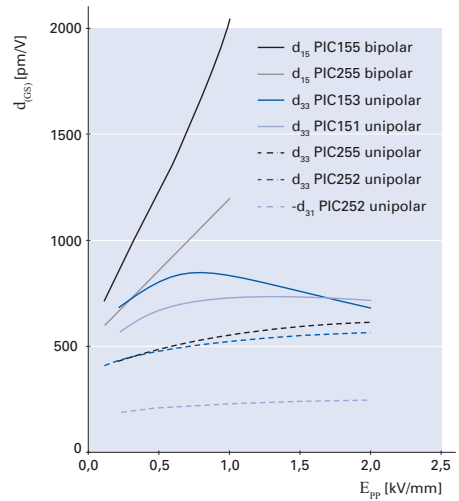

Fig. 22: Piezoelectric large-signal deformation coefficients  $d_{(GS)}$  for different materials and control modes at room temperature and with quasistatic control. With very small field amplitudes, the values of the coefficients match the material constants on p. 128

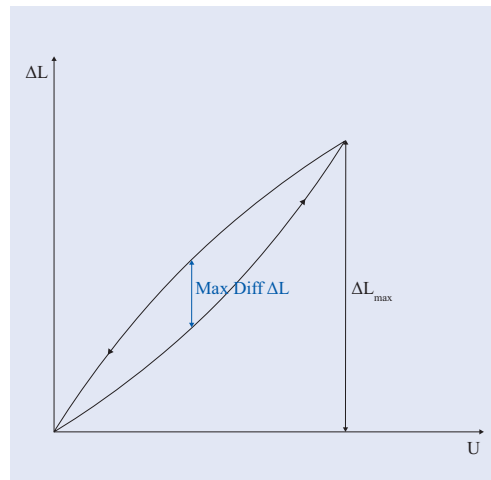

Fig. 23: The hysteresis value  $H_{disp}$  is defined as the ratio between the maximum opening of the curve and the maximum displacement

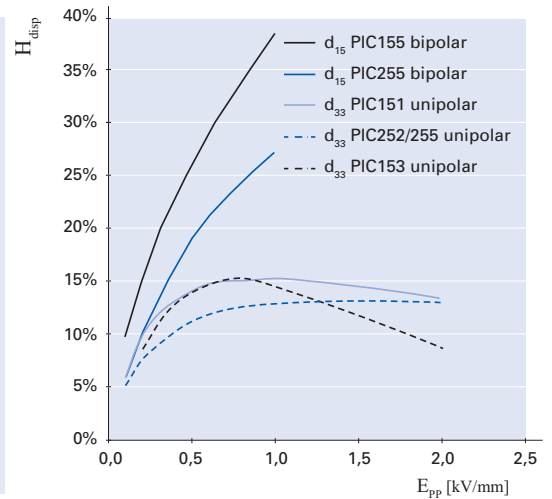

Fig. 24: Displacement hysteresis  $H_{disp}$  of various actuator materials in open-loop, voltage-controlled operation for different drive modes at room temperature and with quasistatic control

### Hysteresis

In open-loop, voltage-controlled operation, the displacement curves of piezo actuators show a strong hysteresis (fig. 24) that usually rises with an increasing voltage or field strength.

Especially high values result for shear actuators or with bipolar control. The reason for these values is the increasing involvement of extrinsic polarity reversal processes in the overall signal.

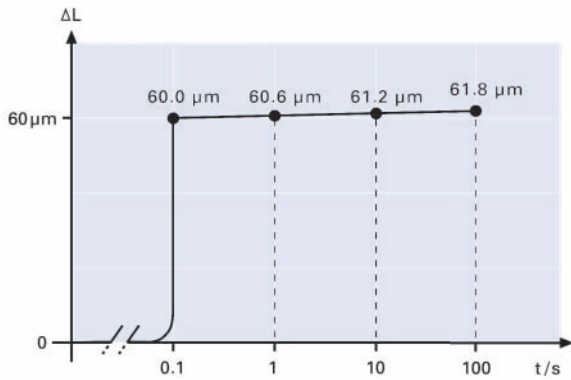

Fig. 25: Displacement of a piezo actuator when driven with a sudden voltage change (step function). The creep causes approx. 1% of the displacement change per logarithmic decade

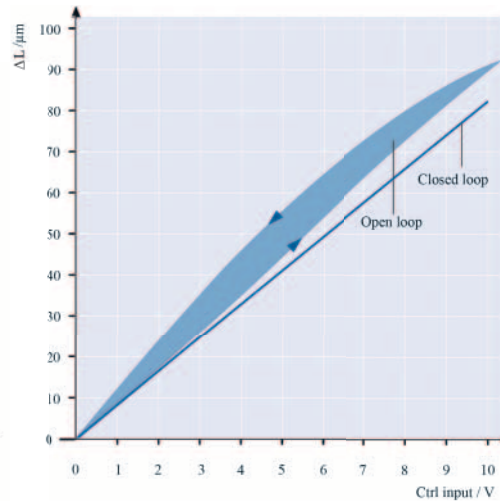

Fig. 26: Elimination of hysteresis and creep in a piezo actuator through position control

### Creep

Creep describes the change in the displacement over time with an unchanged drive voltage. The creep speed decreases logarithmically over time. The same material properties that are responsible for the hysteresis also cause the creep behavior:

$$\Delta L(t) \approx \Delta L_{t=0.1s} \left[ 1 + \gamma \lg\left(\frac{t}{0.1s}\right) \right] \quad (\text{Equation 12})$$

$t$	Time [s]
$\Delta L(t)$	Displacement as a function of time [m]
$\Delta L_{t=0.1s}$	Displacement at 0.1 seconds after the end of the voltage change [m]
$\gamma$	Creep factor, depends on the material properties (approx. 0.01 to 0.02, corresponds to 1% to 2% per decade)

### Position Control

Hysteresis and creep of piezo actuators can be eliminated the most effectively through position control in a closed servo loop. To build position-controlled systems, the PI Ceramic piezo actuators of the PICA Stack and PICA Power product line can be optionally offered with applied strain gauges.

In applications with a purely dynamic control, the hysteresis can be effectively reduced to values of 1 to 2% even with open-loop control by using a charge-control amplifier (p. 155).

# Temperature-Dependent Behavior

## Properties of Piezoelectric Actuators

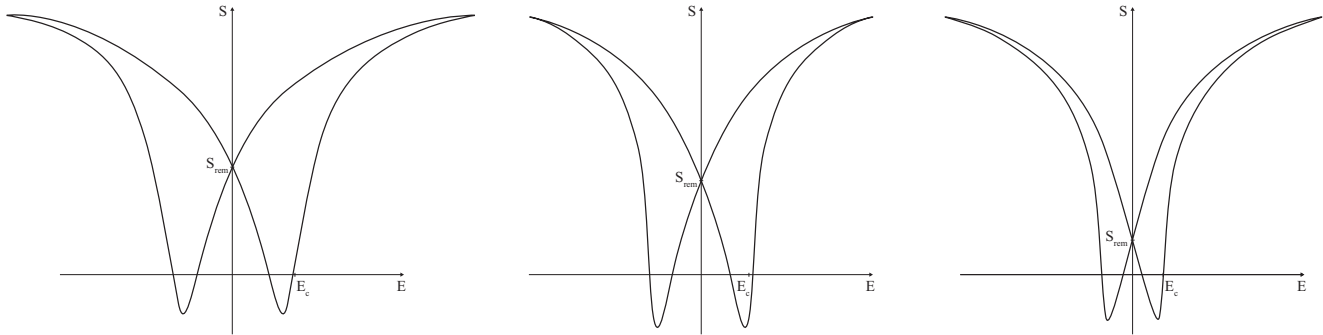

Fig. 27: Bipolar electromechanical large-signal curve of piezo actuators at different temperatures. From left: behavior at low temperatures, at room temperature, at high temperatures

Below the Curie temperature, the temperature dependence of the remnant strain and the coercive field strength is decisive for the temperature behavior. Both the attainable displacement with electric operation and the dimensions of the piezoceramic element change depending on the temperature.

The cooler the piezo actuator, the greater the remnant strain  $S_{rem}$  and the coercive field strength  $E_{rem}$  (fig. 27). The curves become increasingly flatter with decreasing temperatures. This causes the strain induced by a unipolar control to become smaller and smaller even though the total amplitude of the bipolar strain curve hardly changes over wide temperature ranges. The lower the temperature, the greater the remnant strain. All in all, the piezo ceramic has a negative thermal expansion coefficient, i.e., the piezo ceramic becomes longer when it cools down. In comparison: A technical ceramic contracts with a relatively low thermal expansion coefficient upon cooling. This surprising effect is stronger, the more completely the piezo ceramic is polarized.

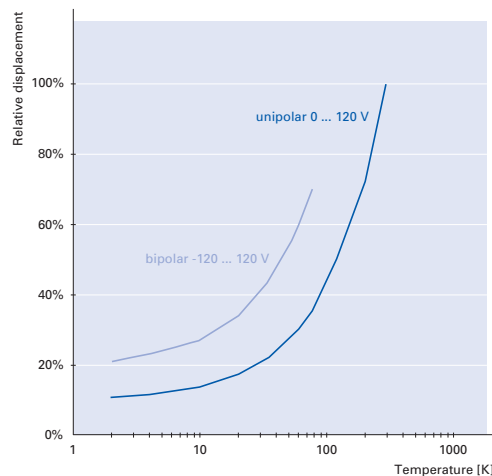

Fig. 28: Relative decrease in the displacement using the example of a PICMA® Stack actuator in the cryogenic temperature range with different piezo voltages in relation to nominal displacement at room temperature

### Displacement as a Function of the Temperature

How much a key parameter of the piezo actuator changes with the temperature depends on the distance from the Curie temperature. PICMA® actuators have a relatively high Curie temperature of 350°C. At high operating temperatures, their displacement only changes by the factor of 0.05%/K.

At cryogenic temperatures, the displacement decreases. When driven unipolarly in the liquid-helium temperature range, piezo actuators only achieve 10 to 15% of the displacement at room temperature. Considerably higher displacements at lower temperatures can be achieved with a bipolar drive. Since the coercive field strength increases with cooling (fig. 27), it is possible to operate the actuator with higher voltages, even against its polarization direction.

### Dimension as a Function of the Temperature

The temperature expansion coefficient of an all-ceramic PICMA® Stack actuator is approximately -2.5 ppm/K. In contrast, the additional metal contact plates as well as the adhesive layers in a PICA Stack actuator lead to a non-linear characteristic with a positive total coefficient (fig. 29).

If a nanopositioning system is operated in a closed servo loop, this will eliminate temperature drift in addition to the nonlinearity, hysteresis, and creep. The control reserve to be kept for this purpose, however, reduces the usable displacement.

For this reason, the temperature drift is often passively compensated for by a suitable selection of the involved materials, the actuator types, and the system design. For example, all-ceramic PICMA® Bender actuators show only a minimal temperature drift in the displacement direction due to their symmetrical structure.

### Temperature Operating Range

The standard temperature operating range of glued actuators is -20 to 85°C. Selecting piezo ceramics with high Curie temperatures and suitable adhesives can increase this range. Most PICMA® multilayer products are specified for the extended range of -40 to 150°C. With special solders, the temperature range can be increased so that special models of PICMA® actuators can be used between -271°C and 200°C i.e. over a range of almost 500 K.

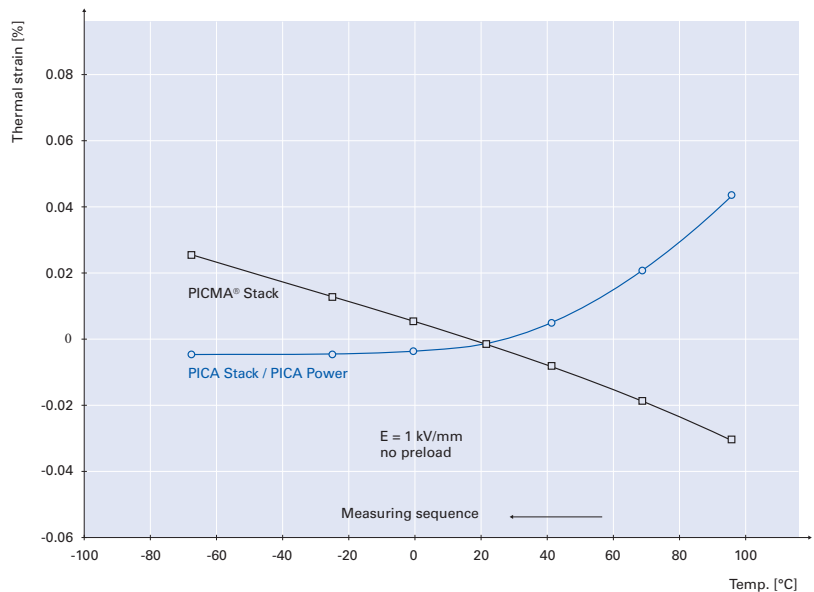

Fig. 29: Temperature expansion behavior of PICMA® and PICA actuators with electric large-signal control

# Forces and Stiffnesses

## Properties of Piezoelectric Actuators

$E^*$	Effective elasticity module: Linear increase of a stress-strain curve of a sample body or actuator made of the corresponding piezoceramic material (fig. 30)
$A$	Actuator cross-sectional area
$l$	Actuator length
$k_A$	Actuator stiffness
$\Delta L_0$	Nominal displacement
$F_{\max}$	Blocking force
$k_L$	Load stiffness
$F_{\text{eff}}$	Effective force

### Preload and Load Capacity

The tensile strengths of brittle piezoceramic and single-crystal actuators are relatively low, with values in the range of 5 to 10 MPa. It is therefore recommended to mechanically preload the actuators in the installation. The preload should be selected as low as possible. According to experience, 15 MPa is sufficient to compensate for dynamic forces (p. 146); in the case of a constant load, 30 MPa should not be exceeded.

Lateral forces primarily cause shearing stresses in short actuators. In longer actuators with a larger aspect ratio, bending stresses are also generated. The sum of both loads yield the maximum lateral load capacities that are given for the PICA shear actuators in the data sheet. However, it is normally recommended to protect the actuators against lateral forces by using guidings.

### Stiffness

The actuator stiffness  $k_A$  is an important parameter for calculating force generation, resonant frequency, and system behavior. Piezoceramic stack actuators are characterized by very high stiffness values of up to several hundred newtons per micrometer. The following equation is used for calculation:

$$k_{A \text{ Stack}} = \frac{E^* A}{l} \quad (\text{Equation 13})$$

Bending actuators, however, have stiffnesses of a few Newtons per millimeter, lower by several orders of magnitude. In addition to the geometry, the actuator stiffness also depends on the effective elasticity module  $E^*$ . Because of the mechanical depolarization processes, the shape of the stress-strain curves (fig. 30) is similarly nonlinear and subject to hysteresis as are the electromechanical curves (fig. 21). In addition, the shape of the curve depends on the respective electrical control conditions, the drive frequency, and the mechanical preload so that values in a range from 25 to 60 GPa can be measured. As a consequence, it is difficult to define a generally valid stiffness value.

For specifying piezo actuators, the quasistatic large-signal stiffness is determined with simultaneous control with a high field strength or voltage and low mechanical preload. As a result, an unfavorable operating case is considered, i.e. the actual actuator stiffness in an application is often higher.

The adhesive layers in the PICA actuators only reduce the stiffness slightly. By using optimized technologies, the adhesive gaps are only a few micrometers high so that the large-signal stiffness is only approx. 10 to 20% lower than that of multilayer actuators without adhesive layers.

The actuator design has a much stronger influence on the total stiffness, e.g. spherical end piece with a relatively flexible point contact to the opposite face.

### Limitations of the Preload

The actuator begins to mechanically depolarize at only a few tens of MPa. A large-signal control repolarizes the actuator; on the one hand, this causes the induced displacement to increase but on the other hand, the effective capacity and loss values increase as well, which is detrimental to the lifetime of the component.

A pressure preload also partially generates tensile stress (p. 156). For this reason, when very high preloads are used, the tensile strength can locally be exceeded, resulting in a possible reduction of lifetime or damage to the actuator. The amount of the possible preload is not determined by the strength of the ceramic material. Piezo actuators attain compressive strengths of more than 250 MPa.



## Force Generation and Displacement

The generation of force or displacement in the piezo actuator can best be understood from the working graph (fig. 32). Each curve is determined by two values, the nominal displacement and the blocking force.

### Nominal Displacement

The nominal displacement  $\Delta L_0$  is specified in the technical data of an actuator. To determine this value, the actuator is operated freely, i.e. without a spring preload, so that no force has to be produced during displacement. After the corresponding voltage has been applied, the displacement is measured.

### Blocking Force

The blocking force  $F_{max}$  is the maximum force produced by the actuator. This force is achieved when the displacement of the actuator is completely blocked, i.e. it works against a load with an infinitely high stiffness.

Since such a stiffness does not exist in reality, the blocking force is measured as follows: The actuator length before operation is recorded. The actuator is displaced without a load to the nominal displacement and then pushed back to the initial position with an increasing external force. The force required for this purpose amounts to the blocking force.

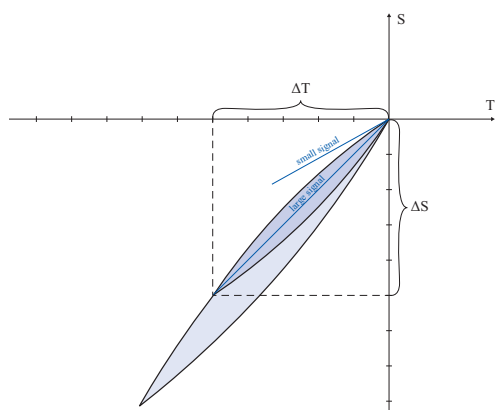

Fig. 30: Stress-strain curve of a piezoceramic stack actuator when driven with a high field strength, in order to prevent mechanical depolarizations. The linear increase  $\Delta T/\Delta S$  defines the effective large-signal elasticity module  $E^*_{(GS)}$ . Small-signal values of the elasticity modules are always greater than large-signal values

## Typical Load Cases

The actuator stiffness  $k_A$  can be taken from the working graph (fig. 32):

$$k_A = \frac{F_{max}}{\Delta L_0} \quad (\text{Equation 14})$$

It corresponds to the inverted slope of the curve. The actuator makes it possible to attain any displacement/force point on and below the nominal voltage curve, with a corresponding load and drive.

### Displacement without Preload, Load with Low Stiffness

If the piezo actuator works against a spring force, its induced displacement decreases because a counterforce builds up when the spring compresses. In most applications of piezo actuators, the effective stiffness of the load  $k_L$  is considerably lower than the stiffness  $k_A$  of the actuator. The resulting displacement  $\Delta L$  is thus closer to the nominal displacement  $\Delta L_0$ :

$$\Delta L \approx \Delta L_0 \left( \frac{k_A}{k_A + k_L} \right) \quad (\text{Equation 15})$$

The displacement/force curve in fig. 31 on the right is called the working curve of the actuator/spring system. The slope of the working curve  $F_{eff}/\Delta L$  corresponds to the load stiffness  $k_L$ .

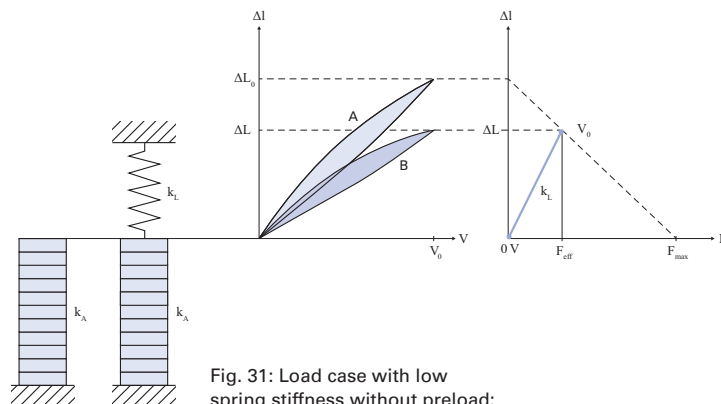

Fig. 31: Load case with low spring stiffness without preload: Drawing, displacement/voltage graph, working graph with working curve

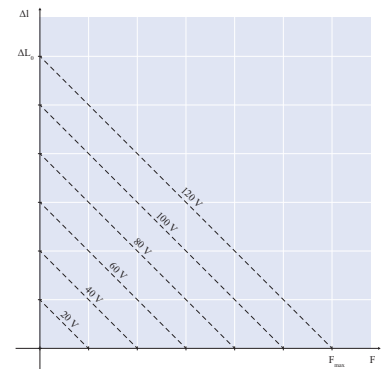

Fig. 32: Working graph of a PICMA® stack actuator with unipolar operation at different voltage levels

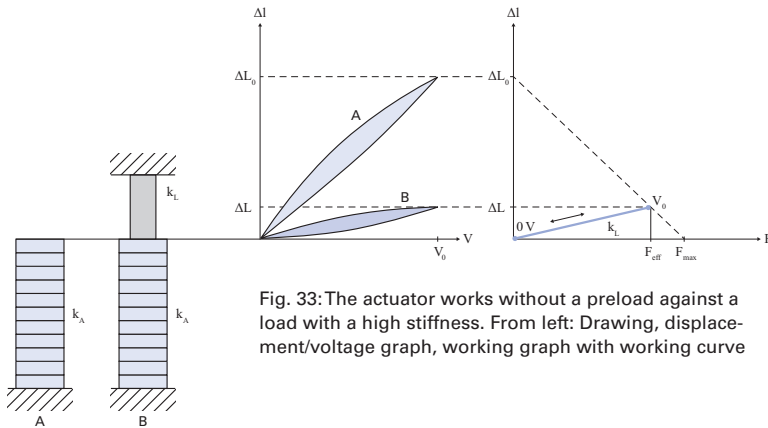

Fig. 33: The actuator works without a preload against a load with a high stiffness. From left: Drawing, displacement/voltage graph, working graph with working curve

### Force Generation Without Preload, Load with High Stiffness

When large forces are to be generated, the load stiffness  $k_L$  must be greater than that of the actuator  $k_A$  (fig. 33):

$$F_{\text{eff}} \approx F_{\text{max}} \left( \frac{k_L}{k_A + k_L} \right) \quad (\text{Equation 16})$$

The careful introduction of force is especially important in this load case, since large mechanical loads arise in the actuator. In order to achieve long lifetime, it is imperative to avoid local pull forces (p. 142).

### Nonlinear Load Without Preload, Opening and Closing of a Valve

As an example of a load case in which a nonlinear working curve arises, a valve control is sketched in fig. 34. The beginning of the displacement corresponds to operation without a load. A stronger opposing force acts near the valve closure as a result of the fluid flow. When the valve seat is reached, the displacement is almost completely blocked so that only the force increases.

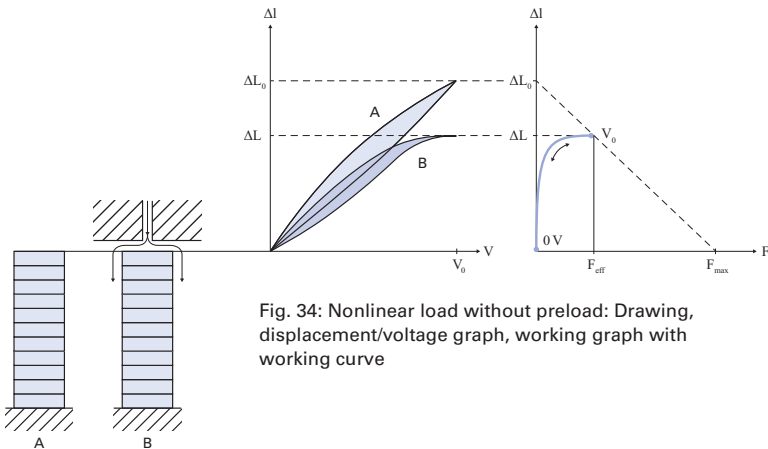

Fig. 34: Nonlinear load without preload: Drawing, displacement/voltage graph, working graph with working curve

### Large Constant Load

If a mass is applied to the actuator, the weight force  $F_v$  causes a compression of the actuator.

The zero position at the beginning of the subsequent drive signal shifts along the stiffness curve of the actuator. No additional force occurs during the subsequent drive signal change so that the working curve approximately corresponds to the course without preload.

An example of such an application is damping the oscillations of a machine with a great mass.

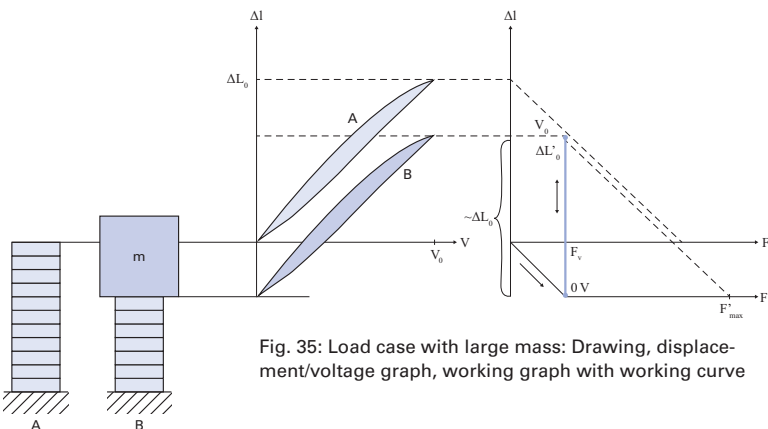

Fig. 35: Load case with large mass: Drawing, displacement/voltage graph, working graph with working curve

Example: The stiffness considerably increases when the actuator is electrically operated with a high impedance, as is the case with charge-control amplifiers (p. 155). When a mechanical load is applied, a charge is generated that cannot flow off due to the high impedance and therefore generates a strong opposing field which increases the stiffness.

### Spring Preload

If the mechanical preload is applied by a relatively soft spring inside a case, the same shift takes place on the stiffness curve as when a mass is applied (fig. 36). With a control voltage applied, however, the actuator generates a small additional force and the displacement decreases somewhat in relation to the case without load due to the preload spring (Equation 15). The stiffness of the preload spring should therefore be at least one order of magnitude lower than that of the actuator.

### Actuator Dimensioning and Energy Consideration

In the case of longitudinal stack actuators, the actuator length is the determining variable for the displacement  $\Delta L_0$ . In the case of nominal field strengths of 2 kV/mm, displacements of 0.10 to 0.15% of the length are achievable. The cross-sectional area determines the blocking force  $F_{max}$ . Approximately 30 N/mm<sup>2</sup> can be achieved here.

The actuator volume is thus the determining parameter for the attainable mechanical energy  $E_{mech} = (\Delta L_0 F_{max})/2$ .

The energy amount  $E_{mech}$  that is converted from electrical to mechanical energy when an actuator is operated, corresponds to the area underneath the curve in fig. 37. However, only a fraction  $E_{out}$  of this total amount can be transferred to the mechanical load. The mechanical system is energetically optimized when the area reaches its maximum. This case occurs when the load stiffness and the actuator

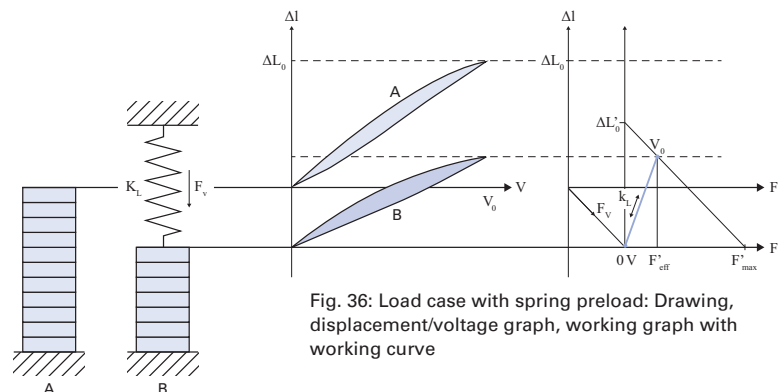

Fig. 36: Load case with spring preload: Drawing, displacement/voltage graph, working graph with working curve

stiffness are equal. The light blue area in the working graph corresponds to this amount. A longitudinal piezo actuator can perform approx. 2 to 5 mJ/cm<sup>3</sup> of mechanical work and a bending actuator achieves around 10 times lower values.

### Efficiency and Energy Balance of a Piezo Actuator System

The calculation and optimization of the total efficiency of a piezo actuator system depends on the efficiency of the amplifier electronics, the electromechanical conversion, the mechanical energy transfer, and the possible energy recovery. The majority of electrical and mechanical energies are basically reactive energies that can be recovered minus the losses, e.g. from heat generation. This makes it possible to construct very efficient piezo systems, especially for dynamic applications.

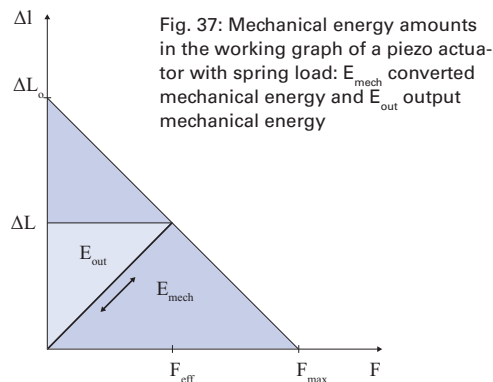

Fig. 37: Mechanical energy amounts in the working graph of a piezo actuator with spring load:  $E_{mech}$  converted mechanical energy and  $E_{out}$  output mechanical energy

# Dynamic Operation

## Properties of Piezoelectric Actuators

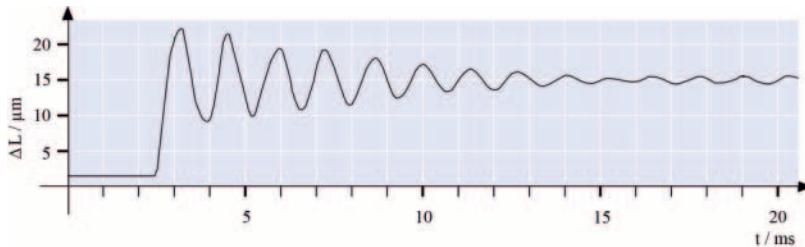

Fig. 38: Displacement of an undamped piezo system after a voltage jump. The nominal displacement is attained after around one third of the period length

This behavior is desired especially in dynamic applications, such as scanning microscopy, image stabilization, valve controls, generating shockwaves, or active vibration damping. When the control voltage suddenly increases, a piezo actuator can reach its nominal displacement in approximately one third of the period of its resonant frequency  $f_0$  (fig. 38).

$$T_{min} \approx \frac{1}{3f_0} \quad (\text{Equation 19})$$

In this case, a strong overshoot occurs which can be partially compensated for with corresponding control technology.

Example: A unilaterally clamped piezo actuator with a resonant frequency of  $f_0 = 10$  kHz can reach its nominal displacement in 30  $\mu$ s.

### Dynamic Forces

With suitable drive electronics, piezo actuators can generate high accelerations of several ten thousand  $m/s^2$ . As a result of the inertia of possible coupled masses as well as of the actuators themselves, dynamic pull forces occur that have to be compensated for with mechanical preloads (p. 142 ff).

In sinusoidal operation, the maximum forces can be estimated as follows:

$$F_{dyn} \approx \pm 4\pi^2 m_{eff} \frac{\Delta L}{f^2} \quad (\text{Equation 20})$$

Example: The dynamic forces at 1000 Hz, 2  $\mu$ m displacement (peak-to-peak) and 1 kg mass are approximately  $\pm 40$  N.

$m$	Mass of the piezo actuator
$M$	Additional load
$\varphi$	Phase angle [degree]
$f_0$	Resonant frequency without load [Hz]
$f_0'$	Resonant frequency with load [Hz]
$F_{dyn}$	Dynamic force [N]
$m_{eff}$	Effective mass of the piezo stack actuator [kg]
$m_{eff}'$	Effective mass of the piezo stack actuator with load [kg]
$\Delta L$	Displacement (peak-peak) [m]
$f$	Control frequency [Hz]

### Resonant frequency

The resonant frequencies specified for longitudinal stack actuators apply to operation when not clamped on both sides. In an arrangement with unilateral clamping, the value has to be divided in half.

The reducing influence of an additional load on the resonant frequency can be estimated with the following equation:

$$f_0' = f_0 \sqrt{\frac{m_{eff}}{m_{eff}'}} \quad (\text{Equation 17})$$

In positioning applications, piezo actuators are operated considerably below the resonant frequency in order to keep the phase shift between the control signal and the displacement low. The phase response of a piezo system can be approximated by a second order system:

$$\varphi \approx 2 \arctan \left( \frac{f}{f_0} \right) \quad (\text{Equation 18})$$

### How Fast Can a Piezo Actuator Expand?

Fast response behavior is a characteristic feature of piezo actuators. A fast change in the operating voltage causes a fast position change.

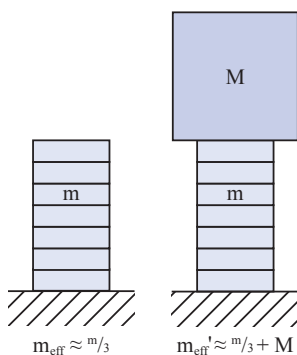

Fig. 39: Calculation of the effective masses  $m_{eff}$  and  $m_{eff}'$  of a unilaterally clamped piezo stack actuator without and with load

# Electrical Operation

## Properties of Piezoelectric Actuators

### Operating Voltage

PI Ceramic offers various types of piezo actuators with different layer thicknesses. This results in nominal operating voltages from 60 V for PICMA® Bender actuators to up to 1000 V for actuators of the PICA series.

### Electrical Behavior

At operating frequencies well below the resonant frequency, a piezo actuator behaves like a capacitor. The actuator displacement is proportional to the stored electrical charge, as a first order estimate.

The capacitance of the actuator depends on the area and thickness of the ceramic as well as the material properties. In the case of actuators that are constructed of several ceramic layers electrically connected in parallel, the capacitance also depends on the number of layers.

In the actuators there are leakage current losses in the  $\mu\text{A}$  range or below due to the high internal resistance.

### Electrical Capacitance Values

The actuator capacitance values indicated in the technical data tables are small-signal values, i.e. measured at 1 V, 1000 Hz, 20°C, unloaded. The capacitance of piezoceramics changes with the voltage amplitude, the temperature and the mechanical load, to up to 200% of the unloaded, small-signal, room-temperature value. For calculations under

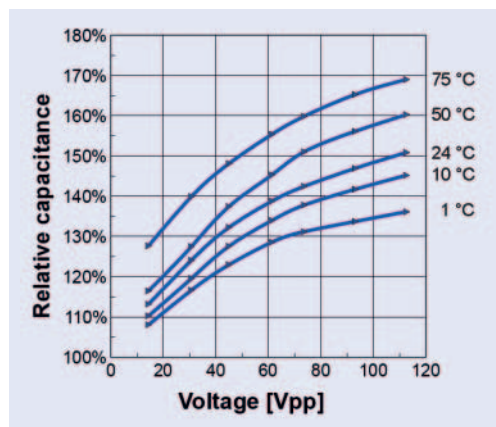

Fig. 40: Relative change of capacitance of a PICMA® Stack actuator measured at 1 kHz unipolar sine signal. The electrical capacitance increases along with the operating voltage and temperature

large-signal conditions, it is often sufficient to add a safety factor of 70% of the small-signal capacitance (fig. 40).

The small-signal capacitance  $C$  of a stack actuator can be estimated as for a capacitor:

$$C = n \cdot \frac{\epsilon_{33}^T \cdot A}{h_L} \quad (\text{Equation 21})$$

With a fixed actuator length  $l$  the following holds true with  $n \approx l/h_L$ :

$$C = l \cdot \frac{\epsilon_{33}^T \cdot A}{h_L^2} \quad (\text{Equation 22})$$

Accordingly, a PICMA® stack actuator with a layer thickness of 60  $\mu\text{m}$  has an approx. 70 times higher capacitance than a PICA stack actuator with the same volume and a layer thickness of 500  $\mu\text{m}$ . The electric power consumption  $P$  of both types is roughly the same due to the relationship  $P \sim CV^2$  since the operating voltage changes proportionally to the layer thickness.

### Positioning Operation, Static and with Low Dynamics

When electrically charged, the amount of energy stored in a piezo actuator is around  $E = \frac{1}{2} CV^2$ . Every change in the charge (and therefore in displacement) is connected with a charge transport that requires the following current  $I$ :

$$I = \frac{dQ}{dt} = C \cdot \frac{dV}{dt} \quad (\text{Equation 23})$$

Slow position changes only require a low current. To hold the position, it is only necessary to compensate for the very low leakage currents, even in the case of very high loads. The power consumption is correspondingly low.

Even when suddenly disconnected from the electrical source, the charged actuator will not make a sudden move. The discharge and thus the return to zero position will happen continuously and very slowly.

$C$	Capacitance [C]
$n$	Number of ceramic layers in the actuator
$\epsilon_{33}^T$	Permittivity = $\epsilon_{33}/\epsilon_0$ (cf. table p. 128) [As/Vm]
$A$	Actuator cross-sectional area [ $\text{m}^2$ ]
$l$	Actuator length [m]
$h_L$	Layer thickness in the actuator [m]
$I$	Current [A]
$Q$	Charge [C, As]
$V$	Voltage on the piezo actuator [V]
$t$	Time [s]

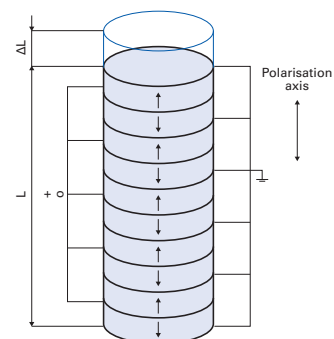

Fig. 41: Structure and contacting of a stacked piezo translator

The average current, peak current and small-signal bandwidth for each piezo amplifier from PI can be found in the technical data.

$P$	Power that is converted into heat [W]
$\tan \delta$	Dielectric loss factor (ratio of active power to reactive power)
$f$	Operating frequency [Hz]
$C$	Actuator capacitance [F]
$V_{pp}$	Driving voltage (peak-to-peak) [V]

### Operation with Position Control

In closed-loop operation, the maximum safe operating frequency is also limited by the phase and amplitude response of the system. Rule of thumb: The higher the resonant frequency of the mechanical system, the higher the control bandwidth can be set. The sensor bandwidth and performance of the servo (digital or analog, filter and controller type, bandwidth) also limit the operating bandwidth of the positioning system.

### Power Consumption of the Piezo Actuator

In dynamic applications, the power consumption of the actuator increases linearly with the frequency and actuator capacitance. A compact piezo translator with a load capacity of approx. 100 N requires less than 10 Watt of reactive power with 1000 Hz and 10  $\mu\text{m}$  stroke, whereas a high-load actuator (>10 kN load) requires several 100 Watt under the same conditions.

### Heat Generation in a Piezo Element in Dynamic Operation

Since piezo actuators behave like capacitive loads, their charge and discharge currents increase with the operating frequency. The thermal active power  $P$  generated in the actuator can be estimated as follows:

$$P \approx \frac{\pi}{4} \cdot \tan \delta \cdot f \cdot C \cdot V_{pp}^2 \quad (\text{Equation 24})$$

For actuator piezo ceramics under small-signal conditions, the loss factor is on the order of 0.01 to 0.02. This means that up to 2% of the electrical power flowing through the actuator is converted into heat. In the case of large-signal conditions, this can increase to considerably higher values (fig. 42). Therefore, the maximum operating frequency also depends on the permissible operating temperature. At high frequencies and voltage amplitudes,

Fig. 42: Dielectric loss factors  $\tan \delta$  for different materials and control modes at room temperature and with quasistatic control. The conversion between voltage and field strength for specific actuators is done with the layer thicknesses that are given starting on p. 134. The actual loss factor in the component depends on further factors such as the mechanical preload, the temperature, the control frequency, and the amount of passive material.

cooling measures may be necessary. For these applications, PI Ceramic also offers piezo actuators with integrated temperature sensors to monitor the ceramic temperature.

### Continuous Dynamic Operation

To be able to operate a piezo actuator at the desired dynamics, the piezo amplifier must meet certain minimal requirements. To assess these requirements, the relationship between amplifier output current, operating voltage of the piezo actuator, and operating frequency has to be considered.

### Driving with Sine Functions

The effective or average current  $I_a$  of the amplifier specified in the data sheets is the crucial parameter for continuous operation with a sine wave. Under the defined ambient conditions, the average current values are guaranteed without a time limit.

$$I_a \approx f \cdot C \cdot V_{pp} \quad (\text{Equation 25})$$

Equation 26 can be used for sinusoidal single pulses that are delivered for a short time only. The equation yields the required peak current for a half-wave. The amplifier must be capable of delivering this peak current at least for half of a period. For repeated single pulses, the time average of the peak currents must not exceed the permitted average current.

$$I_{max} \approx f \cdot \pi \cdot C \cdot V_{pp} \quad (\text{Equation 26})$$

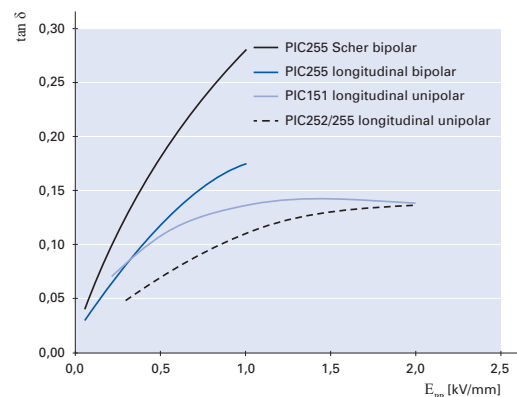

### Driving with Triangular Waveform

Both the average current and the peak current of the amplifier are relevant for driving a piezo actuator with a symmetrical triangular waveform. The maximum operating frequency of an amplifier can be estimated as follows:

$$f_{max} \approx \frac{I}{C} \cdot \frac{I_a}{V_{pp}} \quad (\text{Equation 27})$$

A secondary constraint that applies here is that the amplifier must be capable of delivering at least  $I_{max} = 2 I_a$  for the charging time, i.e. for half of the period. If this is not feasible, an appropriately lower maximum operating frequency should be selected. For amplifiers which cannot deliver a higher peak current or not for a sufficient period of time, the following equation should be used for calculation instead:

$$f_{max} \approx \frac{I}{2 \cdot C} \cdot \frac{I_a}{V_{pp}} \quad (\text{Equation 28})$$

### Signal Shape and Bandwidth

In addition to estimating the power of the piezo amplifier, assessing the small-signal bandwidth is important with all signal shapes that deviate from the sinusoidal shape.

The less the harmonics of the control signal are transferred, the more the resulting shape returns to the shape of the dominant wave, i.e. the sinusoidal shape. The bandwidth should therefore be at least ten-fold higher than the basic frequency in order to prevent signal bias resulting from the nontransferred harmonics.

In practice, the limit of usable frequency portions to which the mechanical piezo system can respond is the mechanical resonant frequency. For this reason, the electrical control signal does not need to include clearly higher frequency portions.

### Switching Applications, Pulse-Mode Operation

The fastest displacement of a piezo actuator can occur in 1/3 of the period of its resonant frequency (p. 146). Response times in the microsecond range and accelerations of more than 10000 g are feasible, but require particularly high peak current from the piezo amplifier.

This makes fast switching applications such as injection valves, hydraulic valves, switching relays, optical switches, and adaptive optics possible.

For charging processes with constant current, the minimal rise time in pulse-mode operation can be determined using the following equation:

$$t \approx C \cdot \frac{V_{pp}}{I_{max}} \quad (\text{Equation 29})$$

As before, the small-signal bandwidth of the amplifier is crucial. The rise time of the amplifier must be clearly shorter than the piezo response time in order not to have the amplifier limit the displacement. In practice, as a rule-of-thumb, the bandwidth of the amplifier should be two- to three-fold larger than the resonant frequency.

### Advantages and Disadvantages of Position Control

A closed-loop controller always operates in the linear range of voltages and currents. Since the peak current is limited in time and is therefore nonlinear, it cannot be used for a stable selection of control parameters. As a result, position control limits the bandwidth and does not allow for pulse-mode operation as described.

In switching applications, it may not be possible to attain the necessary positional stability and linearity with position control. Linearization can be attained e.g. by means of charge-controlled amplifiers (p. 155) or by numerical correction methods.

$I_a$	Average current of the amplifier (source / sink) [A]
$I_{max}$	Peak current of the amplifier (source / sink) [A]
$f$	Operating frequency [Hz]
$f_{max}$	Maximum operating frequency [Hz]
$C$	Actuator capacitance, large signal [Farad (As/V)]
$V_{pp}$	Driving voltage (peak-to-peak) [V]
$t$	Time to charge piezo actuator to $V_{pp}$ [s]

The average current and peak current for each piezo amplifier from PI can be found in the technical data.



Fig. 43: PICMA® actuators with patented, meander-shaped external electrodes for up to 20 A charging current

# Ambient Conditions

## Properties of Piezoelectric Actuators

In case of questions regarding use in special environments, please contact

[info@pi.ws](mailto:info@pi.ws) or  
[info@piceramic.com](mailto:info@piceramic.com)

Piezo actuators are suitable for operation in very different, sometimes extreme ambient conditions. Information on use at high temperatures of up to 200°C as well as in cryogenic environments is found starting on p. 140.

### Vacuum Environment

#### *Dielectric Stability*

According to Paschen's Law, the breakdown voltage of a gas depends on the product of the pressure  $p$  and the electrode gap  $s$ . Air has very good insulation values at atmospheric pressure and at very low pressures. The minimum breakdown voltage of 300 V corresponds to a  $ps$  product of 1000 Pa mm. PICMA® Stack actuators with nominal voltages of considerably less than 300 V can therefore be operated at any intermediate pressure. In order to prevent breakdowns, PICA piezo actuators with nominal voltages of more than 300 V, however, should not be operated or only be driven at strongly reduced voltages when air is in the pressure range of 100 to 50000 Pa.

#### *Outgassing*

The outgassing behavior depends on the design and construction of the piezo actuators. PICMA® actuators are excellently suited to use in ultrahigh vacuums, since they are manufactured without polymer components and can be baked out at up to 150°C. UHV options with minimum outgassing rates are also offered for different PICA actuators.

### Inert Gases

Piezo actuators are suitable for use in inert gases such as helium, argon, or neon. However, the pressure-dependent flashover resistances of the Paschen curves must also be observed here as well. The ceramic-insulated PICMA® actuators are recommended for this use, since their nominal voltage is below the minimum breakdown voltages of all inert gases. For PICA actuators with higher nominal voltages, the operating voltage should be decreased in particular pressure ranges to reduce the flashover risk.

### Magnetic Fields

Piezo actuators are excellently suited to be used in very high magnetic fields, e.g. at cryogenic temperatures as well. PICMA® actuators are manufactured completely without ferromagnetic materials. PICA stack actuators are optionally available without ferromagnetic components. Residual magnetisms in the range of a few nanotesla have been measured for these products.

### Gamma Radiation

PICMA® actuators can also be operated in high-energy, short-wave radiation, which occurs, for example, with electron accelerators. In long-term tests, problem-free use with total doses of 2 megagray has been proven.

### Environments with High Humidity

When piezo actuators are operated in dry environments, their lifetime is always higher than in high humidity. When the actuators are operated with high-frequency alternating voltages, they self-heat, thus keeping the local moisture very low.

Continuous operation at high DC voltages in a damp environment can damage piezo actuators (p. 151). This especially holds true for the actuators of the PICA series, since their active electrodes are only protected by a polymer coating that can be penetrated by humidity. The actuators of the PICMA® series have an all-ceramic insulation, which considerably improves their lifetime in damp ambient conditions compared to polymer-coated actuators (p. 151).

### Liquids

Encapsulated PICMA® or specially encased PICA actuators are available for use in liquids. For all other actuator types, direct contact with liquids should be avoided. Highly insulating liquids can be exceptions to this rule. Normally, however, the compatibility of the actuators with these liquids must be checked in lifetime tests.



# Reliability of PICMA<sup>®</sup> Multilayer Actuators

## Properties of Piezoelectric Actuators

### Lifetime when Exposed to DC Voltage

In nanopositioning applications, constant voltages are usually applied to the piezo actuator for extended periods of time. In the DC operating mode, the lifetime is influenced mainly by atmospheric humidity.

If the humidity and voltage values are very high, chemical reactions can occur and release hydrogen molecules which then destroy the ceramic composite by embrittling it.

### All-Ceramic Protective Layer

The patented PICMA<sup>®</sup> design suppresses these reactions effectively. In contrast to coating made just of polymer, the inorganic ceramic protective layer (p. 134) prevents the internal electrodes from being exposed to water molecules and thus increases the lifetime by several orders of magnitude (fig. 44).

### Quasi-static Conditions: Accelerated Lifetime Test

Due to their high reliability, it is virtually impossible to experimentally determine the lifetime of PICMA<sup>®</sup> actuators under real application conditions. Therefore, tests under extreme load conditions are used to estimate the lifetime: Elevated atmospheric humidity and simultaneously high ambient temperatures and control voltages.

Fig. 44 shows the results of a test that was conducted at a much increased atmospheric humidity of 90% RH at 100 V DC and 22°C. The extrapolated mean lifetime (MTTF, mean time to failure) of PICMA<sup>®</sup> actuators amounts to more than 400000 h (approx. 47 years) while comparative actuators with polymer coating have an MTTF of only approx. one month under these conditions.

Tests under near-realistic conditions confirm or even surpass these results.

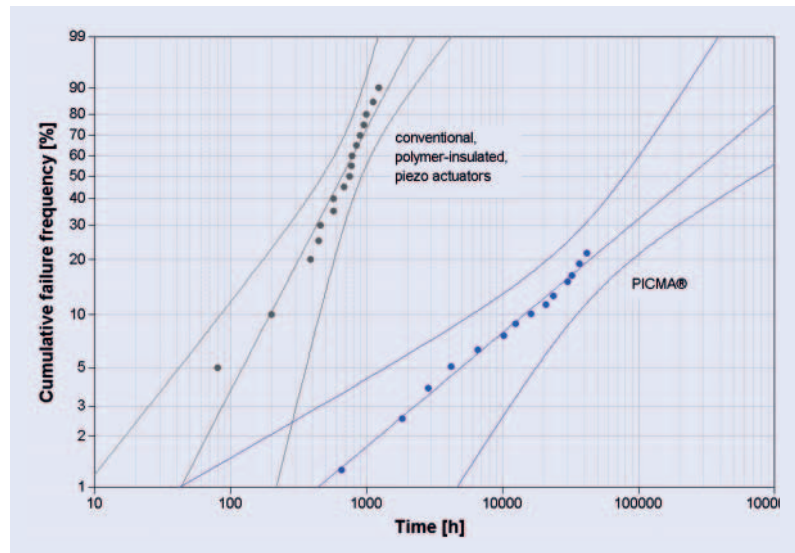

Fig. 44: Results of an accelerated lifetime test with increased humidity (test conditions: PICMA<sup>®</sup> Stack and polymer-coated actuators, dimensions: 5 x 5 x 18 mm<sup>3</sup>, 100 V DC, 22 °C, 90% RH)

### Calculation of the Lifetime when Exposed to DC Voltage

Elaborate investigations have been done to develop a model for calculation of the lifetime of PICMA<sup>®</sup> Stack actuators. The following factors need to be taken into account under actual application conditions: Ambient temperature, relative atmospheric humidity, and applied voltage.

The simple formula

$$MTTF = A_U \cdot A_T \cdot A_F \quad (\text{Equation 30})$$

allows the quick estimation of the average lifetime in hours. The factors  $A_U$  as a function of the operating voltage,  $A_T$  for the ambient temperature and  $A_F$  for the relative atmospheric humidity can be read from the diagram (fig. 45).

### Important:

Decreasing voltage values are associated with exponential increases of the lifetime. The expected lifetime at 80 V DC, for example, is 10 times higher than at 100 V DC.

This calculation can also be used to optimize a new application with regard to lifetime as early as in the design phase. A decrease in the driving voltage or control of temperature and atmospheric humidity by protective air or encapsulation of the actuator can be very important in this regard.

Fig. 45: Diagram for calculating the lifetime of PICMA® stack actuators when exposed to DC voltage. For continuous operation at 100 V DC and 75% atmospheric humidity (RH) and an ambient temperature of 45°C, the following values can be read from the diagram:  $A_r=14$  (humidity, blue curve),  $A_t=100$  (temperature, red curve), and  $A_U=75$  (operating voltage, black curve). The product results in a mean lifetime of 105000 h, more than 11 years

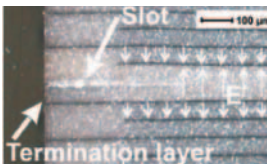
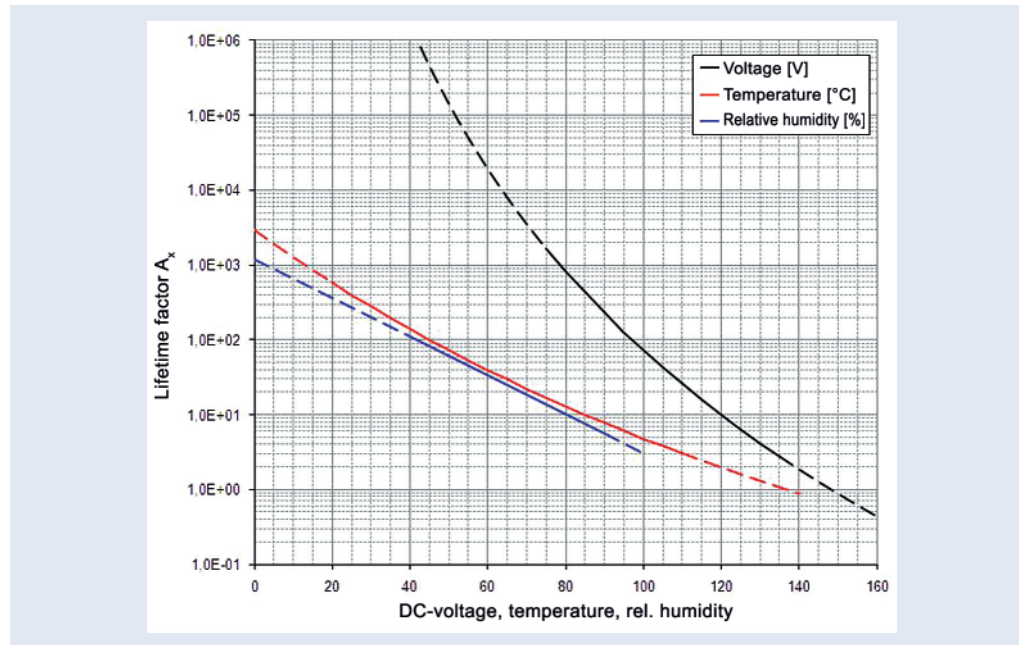

Fig. 46: The patented PICMA® actuator design with its defined slots preventing uncontrolled cracking due to stretching upon dynamic control is clearly visible

### Lifetime in Dynamic Continuous Operation

Cyclic loads with a rapidly alternating electrical field and high control voltages (typically > 50 Hz; > 50 V) are common conditions for applications such as valves or pumps. Piezo actuators can reach extremely high cycles-to-failure under these conditions.

The most important factors affecting the lifetime of piezo actuators in this context are the electrical voltage and the shape of the signal. The impact of the humidity, on the other hand, is negligible because it is reduced locally by the warming-up of the piezo ceramic.

### Ready for Industrial Application: 10<sup>10</sup> Operating Cycles

Tests with very high control frequencies demonstrate the robustness of PICMA® piezo actuators. Preloaded PICMA® actuators with dimensions of 5 x 5 x 36 mm<sup>3</sup> were loaded at room temperature and compressed air cooling with a sinusoidal signal of 120 V unipolar voltage at 1157 Hz, which corresponds to 10<sup>8</sup> cycles daily. Even after more than 10<sup>10</sup> cycles, there was not a single failure and the actuators showed no significant changes in displace-

ment. In recent performance and lifetime tests carried out by NASA, PICMA® actuators still produced 96% of their original performance after 100 billion (10<sup>11</sup>) cycles. Therefore, they were chosen among a number of different piezo actuators for the science lab in the Mars rover "Curiosity". (Source: Piezoelectric multi-layer actuator life test. IEEE Trans Ultrason Ferroelectr Freq Control. 2011 Apr; Sherrit et al. Jet Propulsion Laboratory, California Institute of Technology, Pasadena, CA, USA)

### Patented Design Reduces the Mechanical Stress

PICMA® actuators utilize a special patented design. Slots on the sides effectively prevent excessive increases of mechanical tensile stresses in the passive regions of the stack and the formation of un-controlled cracks (fig. 46) that may lead to electrical breakdowns and thus damage to the actuator. Furthermore, the patented meander-shaped design of the external contact strips (fig. 43) ensures all internal electrodes have a stable electrical contact even at extreme dynamic loads.

# Piezo Electronics for Operating Piezo Actuators

## Characteristic Behavior of Piezo Amplifiers

Fast step-and-settle or slow velocity with high constancy, high positional stability and resolution as well as high dynamics – the requirements placed on piezo systems vary greatly and need drivers and controllers with a high degree of flexibility.

The control electronics play a key role in the performance of piezoelectric actuators and nanopositioning systems. Ultra-low-noise, high-stability linear amplifiers are essential for precise positioning, because piezo actuators respond to the smallest changes in the control voltage with a displacement. Noise or drifting must be avoided as much as possible. The prerequisite for the high-dynamics displacement of the actuator is for the voltage source to provide sufficient current to charge the capacitance.

### Power Requirements for Piezo Operation

The operating limit of an amplifier with a given piezo actuator depends on the amplifier power, the amplifier design and the capacitance of the piezo ceramics (cf. p. 148 – 149). In high-dynamics applications, piezo actuators require high charge and discharge currents. The peak current is of special importance, particularly for sinusoidal operation or pulse operation. Piezo amplifiers from PI are therefore designed so that they can output and sink high peak currents. If an amplifier is operated with a capacitive load and frequency at which it can no longer produce the required current, the output signal will be distorted. As a result, the full displacement can no longer be attained.

### Amplifier Frequency Response Curve

The operating limits of each amplifier model are measured with different piezo loads depending on the frequency and output voltage and are graphically displayed as amplifier response curves to make the selection easier. The measurements are performed after 15 minutes of continuous operation (piezo and amplifier) at room temperature. In cold condition after power up, more power can be briefly available.

The power amplifier operates linearly within its operating limits so that the control signal is amplified without distortion. In particular, no thermal limitation takes place, i.e. the

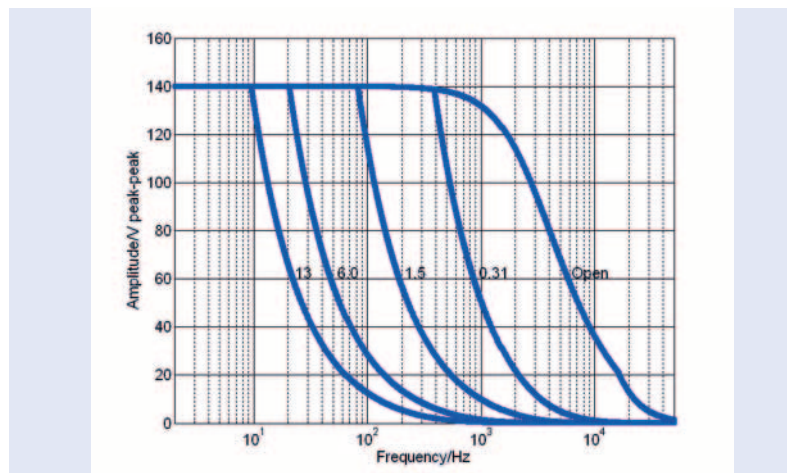

amplifier does not overheat, which could cause distortions of the sine wave. The amplifier continuously provides the output voltage even over a long time. This amplifier response curve cannot be used for peak values that are only available for a short period.

The curves refer to open-loop operation; in closed-loop operation, other factors limit the dynamics.

### Setting the Operating Voltage

After the operating limit of the amplifier has been reached, the amplitude of the control voltage must be reduced by the same proportion as the output voltage falls, if the frequencies continue to increase. This is important because the current requirement continuously increases along with the frequency. Otherwise, the output signal will be distorted.

Example: The E-503 (E-663) amplifier can drive a 23 μF piezo capacitance with a voltage swing of 100 V and a maximum frequency of approximately 15 Hz (with sine wave excitation). At higher frequencies the operating limit decreases, e.g. to 80 V at 20 Hz. In order to obtain a distortion-free output signal at this frequency, the control input voltage must be reduced to 8 V (voltage gain = 10).

Fig. 47: Amplifier frequency response curve, determined with different piezo loads, capacitance values in μF. Control signal sine, operation period >15 min, 20°C

# Solutions for High-Dynamics Operation

## Piezo Electronics for Operating Piezo Actuators

### Switching Amplifiers with Energy Recovery

Piezo actuators are often used for an especially precise materials processing, for example in mechanical engineering for fine positioning in milling and turning machines. These require high forces as well as dynamics. The piezo actuators are correspondingly dimensioned for high forces; i.e. piezo actuators with a high capacity are used here. Particularly high currents are required to charge and discharge them with the necessary dynamics. The control of valves also requires similar properties.

### Energy Recovery Minimizes the Energy Consumption in Continuous Operation

Since these applications frequently run around the clock, seven days a week, the energy consumption of the amplifier is particularly important. For this purpose, PI offers switching amplifier electronics with which the pulse width of the control signal is modulated (PWM) and the piezo voltage is thereby controlled. This results in an especially high efficiency. In addition, a patented circuitry for energy recovery is integrated: this stores part of the returning energy in a capacitive store when

a piezo is discharged and makes the energy available again for the next charging operation. This permits energy savings of up to 80% to be realized. Furthermore, the amplifier does not heat up as much and thus influences the actual application less.

Unlike conventional class D switching amplifiers, PI switching amplifiers for piezo elements are current- and voltage-controlled. Product examples are the E-617 for PICMA<sup>®</sup> actuators and E-481 for the PICA actuator series.

### Protection of the Piezo Actuator through Overtemperature Protection

In continuous operation, the heat development in the piezo actuator is not negligible (p. 148). Corresponding electronics can therefore evaluate the signals of a temperature sensor on the piezo. This protects the ceramic from overheating and depolarization.

### Valid patents

German patent no. 19825210C2  
International patent no. 1080502B1  
US patent no. 6617754B1



Fig. 48: Piezo actuator in a case with connections for temperature sensor and cooling air

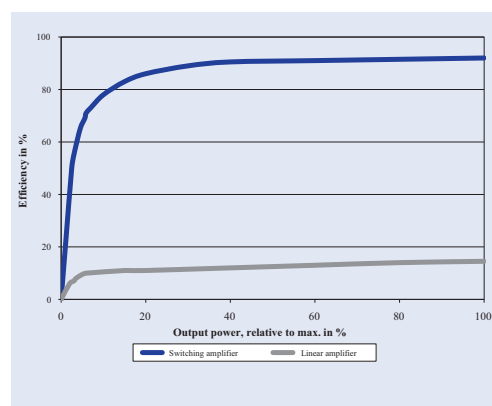

Fig. 49: Thanks to their patented energy recovery system, PI amplifiers only consume approx. 20% of the power required by a corresponding linear amplifier with the same output power

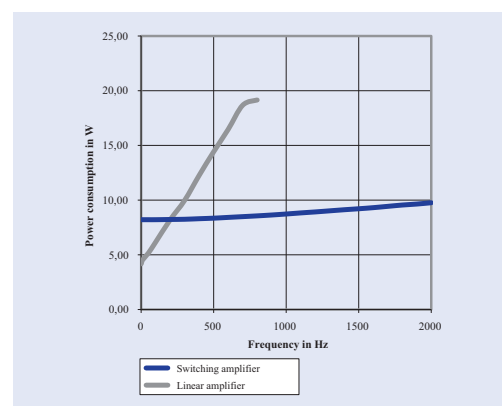

Fig. 50: Power consumption of a piezo amplifier with linear and switched-mode amplifier at the piezo output, capacitive load 1  $\mu$ F. The measured values clearly show that the pulse width modulated amplifier allows significantly higher dynamics than the classic linear amplifier. The linear amplifier reaches the upper limit of its power consumption at frequencies of up to approx. 700 Hz, the switching amplifier does not reach the limit until far beyond 2 kHz

# Linearized Amplifiers for Piezo Displacement Without Hysteresis

## Piezo Electronics for Operating Piezo Actuators

### Charge Control

A typical application for piezo actuators or nanopositioning systems is dynamic scanning. This involves two different methods: step-and-settle operation with precise and repeatable position control on the one hand, and ramp operation with especially linear piezo displacement on the other. The first method requires a closed servo loop which ensures that positions can be approached precisely and repeatedly with constant step sizes.

Of course, ramp operation with linear piezo displacement is also possible using position feedback sensors and a servo loop. However, in this case, the servo loop will determine the dynamics of the entire system which sometimes significantly limits the number of cycles per time unit. This can be avoided by means of an alternative method of amplification: charge control.

### Charge and Displacement

Charge control is based on the principle that the displacement of piezo actuators is much more linear when an electrical charge is applied instead of a voltage. The hysteresis is only 2% with electrical charges, whereas it is between 10 and 15% with open-loop control voltages (fig. 51). Therefore, charge control can often be used to reach the required precision even without servo loop. This enhances the dynamics and reduces the costs. Charge control is not only of advantage as regards highly dynamic applications but also when it comes to operation at very low frequencies. However, charge control is not suitable for applications where positions need to be maintained for a longer period of time.

### For dynamic applications:

- Active vibration damping
- Adaptronics
- High-speed mechanical switches
- Valve control (e.g. pneumatics)
- Dispensing



The charge-controlled E-506.10 power amplifier offers highly linear, dynamic control for PICMA® piezo actuators

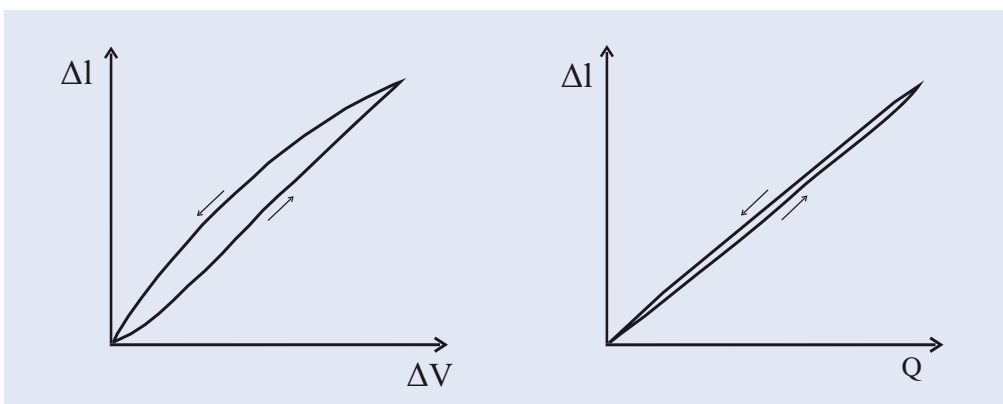

Fig. 51: Typical expansion of piezo actuators in relation to the applied voltage (left) and the charge (right). Controlling the applied charge significantly reduces the hysteresis

# Handling of Piezo Actuators

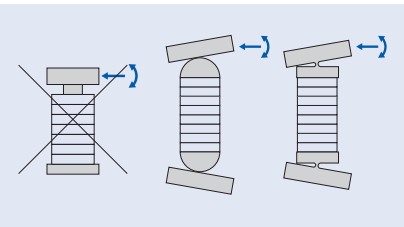

Fig. 52: Avoiding lateral forces and torques

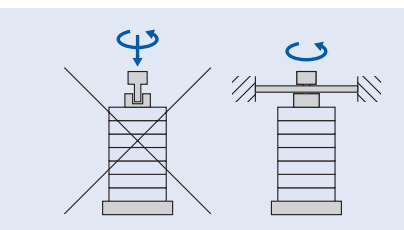

Fig. 53: Prevention of torques

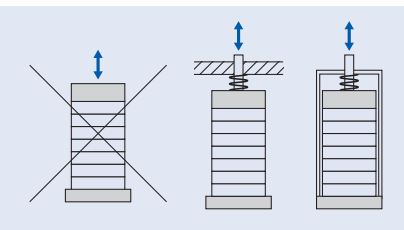

Fig. 54: Avoiding tensile stresses by means of a mechanical preload

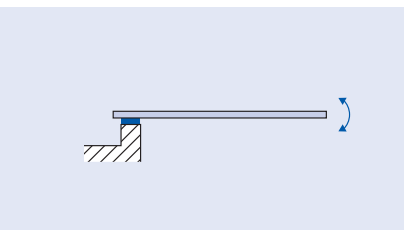

Fig. 55: Mounting of a one-sidedly clamped bending actuator by gluing

Piezo actuators are subject to high mechanical and electrical loads. Moreover, the brittle ceramic or crystalline materials require careful handling.

- ▶ Avoid mechanical shocks to the actuator, which can occur if you drop the actuator, for example.
- ▶ Do not use metal tools during installation.
- ▶ Avoid scratching the ceramic or polymer coating and the end surfaces during installation and use.
- ▶ Prevent the ceramic or polymer insulation from coming into contact with conductive liquids (such as sweat) or metal dust.
- ▶ If the actuator is operated in a vacuum: Observe the information on the permissible piezo voltages for specific pressure ranges (p. 150).
- ▶ If the actuator could come into contact with insulating liquids such as silicone or hydraulic oils: Contact [info@piceramic.com](mailto:info@piceramic.com).
- ▶ If the actuator has accidentally become dirty, carefully clean the actuator with isopropanol or ethanol. Next, completely dry it in a drying cabinet. Never use acetone for cleaning. When cleaning in an ultrasonic bath, reduce the energy input to the necessary minimum.
- ▶ Recommendation: Wear gloves and protective glasses during installation and start-up.

DuraAct patch actuators and encapsulated PICMA<sup>®</sup> piezo actuators have a particularly robust construction. They are partially exempt from this general handling information.

## Mechanical Installation (fig. 52, 53, 54)

- ▶ Avoid torques and lateral forces when mounting and operating the actuator by using suitable structures or guides.
- ▶ When the actuator is operated dynamically: Install the actuator so that the center of mass of the moving system coincides with the actuator axis, and use a guiding for very large masses.
- ▶ Establish contact over as large an area as possible on the end surfaces of a stack actuator.
- ▶ Select opposing surfaces with an evenness of only a few micrometers.

## Gluing

- ▶ If the mounting surface is not even, use epoxy resin glue for gluing the actuators. Cold-hardening, two-component adhesives are well suited for reducing thermo-mechanical stresses.
- ▶ Maintain the operating temperature range specified for the actuator during hardening and observe the temperature expansion coefficients of the involved materials.

Uneven mounting surfaces are found, for example, with PICMA<sup>®</sup> Bender and PICMA<sup>®</sup> Chip actuators, since these surfaces are not ground after sintering (fig. 55).

## Applying a Preload (fig. 54)

- ▶ Create the preload either externally in the mechanical structure or internally in a case.
- ▶ Apply the preload near the axis within the core cross-section of the actuator.
- ▶ If the actuator is dynamically operated and the preload is created with a spring: Use a spring whose total stiffness is approximately one order of magnitude less than that of the actuator.

### Introducing the Load Evenly (fig. 56)

The parallelism tolerances of the mechanical system and the actuator result in an irregular load distribution. Here, compressive stresses may cause tensile stresses in the actuator. Regarding the even application of a load, there are diverse design solutions that differ from each other in axial stiffness, separability of the connection and rotatability in operation, e.g. in the case of lever amplification.

- Gluing the actuator (cf. gluing section)
- Hardened spherical end piece with point contact to even opposing surface
- Hardened spherical end piece with ring contact to a spherical cap
- Connection via a flexure joint
- ▶ If the actuator is coupled in a milling pocket, make sure that there is full-area contact on the end surface of the actuator. For this purpose, select the dimensions of the milling pocket correspondingly or make free cuts in the milling pocket (fig. 57).
- ▶ If a point load is applied to the end piece of the actuator: Dimension the end piece so that its thickness corresponds to half the cross-sectional dimension in order to prevent tensile stresses on the actuator (fig. 58).

### Electrical Connection (fig. 59)

From an electrical point of view, piezo actuators are capacitors that can store a great amount of energy. Their high internal resistances lead to very slow discharges with time constants in the range of hours. Mechanical or thermal loads electrically charge the actuator.

- ▶ Connect the case or the surrounding mechanics to a protective earth conductor in accordance with the standards.

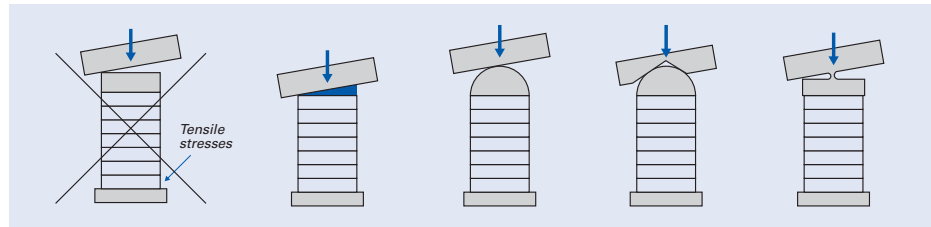

Fig. 56: Avoiding an irregular load application

- Electrically insulate the actuator against the peripheral mechanics. At the same time, observe the legal regulations for the respective application.
- Observe the polarity of the actuator for connection.
- Only mount the actuator when it is short-circuited.
- When the actuator is charged: Discharge the actuator in a controlled manner with a 10 kΩ resistance. Avoid directly short-circuiting the terminals of the actuator.
- ▶ Do not pull out the connecting cable of the amplifier when voltage is present. The mechanical impulse triggered by this could damage the actuator.

### Safe Operation

- ▶ Reduce the DC voltage as far as possible during actuator operation (p. 151). You can decrease offset voltages with semi-bipolar operation.
- ▶ Always power off the actuator when it is not needed.
- ▶ Avoid steep rising edges in the piezo voltage, since they can trigger strong dynamic forces when the actuator does not have a preload. Steep rising edges can occur, for example, when digital wave generators are switched on.

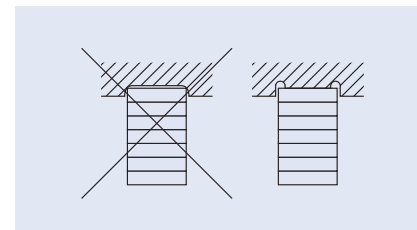

Fig. 57: Full-area contact of the actuator

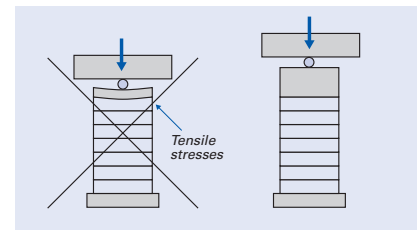

Fig. 58: Proper dimensioning of the end pieces in the case of point contact

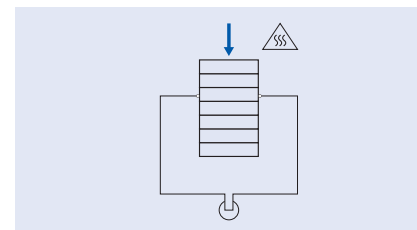

Fig. 59: Mechanical loads electrically charge the actuator. Mounting only when short-circuited





# Patents

PI holds the following product-related patents. They protect the technology and guarantee the technological advance.

We list the patents relevant for each product in product literature and on product labels. In some parts of the world, this is mandatory to keep up patent protection.

Patent	Granted on	Concerns products
German patent no. 10021919	2001-08-08	PICMA <sup>®</sup> , P-88x, all products that use PICMA <sup>®</sup>
German patent no. 10234787	2003-10-30	PICMA <sup>®</sup> , P-88x
German patent no. 10348836	2004-11-08	PICMA <sup>®</sup> , P-88x
US patent no. 7,449,077	2008-11-08	PICMA <sup>®</sup> , all P-5xx, P-6xx, P-7xx, P-8xx, P-9xx
German patent no. 29618149.8	1996-12-05	F-206, F-206.S, H-206
US patent no. 6,765,335 German patent no. 10154526	2004-04-20 2007-02-08	PILine <sup>®</sup> , M-663, M-664, M-272, M-683, M-686, M-687, P-661, U-161, U-164, U-264, U-628
US patent no. 6,800,984 German patent no. 10148267	2004-10-05 2005-11-24	NEXLINE <sup>®</sup> , P-911, N-111, N-216
US patent no. 6,950,050	2005-09-27	HyperBit
German patent no. P4408618.0 European patent 0 624 912 B1	2004-04-22 1997-01-22	NEXACT <sup>®</sup> N-310, N-381, N-664, LPS-24, LPS-65
German patent no. 102004011724	2006-08-10	P-712, P-713
German patent no. 10051784 US patent no. 6,930,439	2002-08-14 2005-08-16	P-876 DuraAct
German patent no. 19825210C2 International patent no. 1080502B1 US patent no. 6617754B1	2003-09-25 2002-07-10 2003-09-09	E-481, E-482, E-504, E-617

# Imprint

---

**Physik Instrumente (PI) GmbH & Co. KG**

Auf der Roemerstrasse 1  
76228 Karlsruhe  
Germany

Tel.: +49 721 4846-0  
Fax: +49 721 4846-1019  
info@pi.ws  
www.pi.ws

General Management: Dr. Karl Spanner (CEO), Norbert Ludwig, Dr. Peter Schittenhelm, Markus Spanner

Commercial Register: Reg.-Gericht Mannheim: HRA 104804  
VAT ID Nr: DE 1431 828 03  
WEEE-Reg.-Nr.: DE 93978928

Partner liable to unlimited extend: Physik Instrumente (PI) Verwaltungs GmbH, Karlsruhe, Germany  
Commercial Register: Reg.-Gericht Mannheim: HRB 109941

Although the information in this document has been compiled with the greatest care, errors cannot be ruled out completely. Therefore, we cannot guarantee for the information being complete, correct and up to date. Illustrations may differ from the original and are not binding. PI reserves the right to supplement or change the information provided without prior notice.

# Trademarks

---

The following company names and brands are registered trademarks of Physik Instrumente (PI) GmbH & Co. KG:  
PI®, PIC®, PICMA®, PILine®, PIFOC®, PiezoWalk®, NEXACT®, NEXLINE®, PInano®, NanoCube®, Picoactuator®, Nanoautomation®

The following company names or brands are the registered trademarks of their owners:  
µManager, LabVIEW, Leica, Linux, MATLAB, MetaMorph, Microsoft, National Instruments, Nikon, Olympus, Windows, Zeiss

CAT130E 05/2013.10000 © Physik Instrumente (PI) GmbH & Co. KG 2013. Subject to change without notice.

All contents, including texts, graphics, data etc., as well as their layout, are subject to copyright and other protective laws. Any copying, modification or redistribution in whole or in parts is subject to a written permission of PI.



**Physik Instrumente (PI)  
GmbH & Co. KG**  
Auf der Roemerstr. 1  
76228 Karlsruhe  
Germany  
Tel. +49 (721) 4846-0  
Fax +49 (721) 4846-1019  
info@pi.ws  
www.pi.ws

#### GERMANY

**PI miCos GmbH**  
Freiburger Str. 30  
79427 Eschbach  
Tel. +49 (7634) 5057-0  
Fax +49 (7634) 5057-99  
info@pimicos.com  
www.pimicos.com

**PI Ceramic GmbH**  
Lindenstr.  
07589 Lederhose  
Tel. +49 (36604) 882-0  
Fax +49 (36604) 882-4109  
info@piceramic.com  
www.piceramic.com

#### USA (East) & CANADA

**PI (Physik Instrumente) L.P.**  
16 Albert St.  
Auburn, MA 01501  
Tel. +1 (508) 832 3456  
Fax +1 (508) 832 0506  
info@pi-usa.us  
www.pi-usa.us

#### USA (West) & MEXICO

**PI (Physik Instrumente) L.P.**  
5420 Trabuco Rd., Suite 100  
Irvine, CA 92620  
Tel. +1 (949) 679 9191  
Fax +1 (949) 679 9292  
info@pi-usa.us  
www.pi-usa.us

#### JAPAN

**PI Japan Co., Ltd.**  
Business Center Bldg. 5F  
2-38-5 Akebono-cho  
Tachikawa-shi, Tokyo 190-0012  
Tel. +81 (42) 526 7300  
Fax +81 (42) 526 7301  
info@pi-japan.jp  
www.pi-japan.jp

**PI Japan Co., Ltd.**  
Hanahara Daini Bldg. #703  
4-11-27 Nishinakajima  
Yodogawa-ku, Osaka-shi  
Osaka 532-0011  
Tel. +81 (6) 6304 5605  
Fax +81 (6) 6304 5606  
info@pi-japan.jp  
www.pi-japan.jp

#### UK & IRELAND

**PI (Physik Instrumente) Ltd.**  
Trent House, University Way,  
Cranfield Technology Park,  
Cranfield, Bedford MK43 0AN  
Tel. +44 (1234) 756 360  
Fax +44 (1234) 756 369  
uk@pi.ws  
www.physikinstrumente.co.uk

#### ITALY

**Physik Instrumente (PI) S. r. l.**  
Via G. Marconi, 28  
20091 Bresso (MI)  
Tel. +39 (02) 665 011 01  
Fax +39 (02) 610 396 56  
info@pionline.it  
www.pionline.it

#### FRANCE

**PI France S.A.S.**  
244 bis, avenue Marx Dormoy  
92120 Montrouge  
Tel. +33 (1) 55 22 60 00  
Fax +33 (1) 41 48 56 62  
info.france@pi.ws  
www.pifrance.fr

#### CHINA

**Physik Instrumente  
(PI Shanghai) Co., Ltd.**  
Building No. 7-106  
Longdong Avenue 3000  
201203 Shanghai, China  
Tel. +86 (21) 518 792 98  
Fax +86 (21) 687 900 98  
info@pi-china.cn  
www.pi-china.cn

#### SOUTH EAST ASIA

**PI (Physik Instrumente)  
Singapore LLP**  
20 Sin Ming Lane  
#05-60 Midview City  
Singapore 573968  
Tel. +65 665 98400  
Fax +65 665 98404  
info-sg@pi.ws  
www.pi-singapore.sg  
For ID / MY / PH / SG / TH

#### KOREA

**PI Korea Ltd.**  
6F Jeongu Bldg.  
Cheonho-Daero 1111  
Gangdong-gu  
138-814 Seoul  
Tel. +82 (2) 475-0060  
Fax +82 (2) 475-3663  
info-kr@pi.ws  
www.pi-korea.ws