

Motion Systems for Electronics Manufacturing

PLACE → ALIGN → PROCESS → INSPECT → TEST

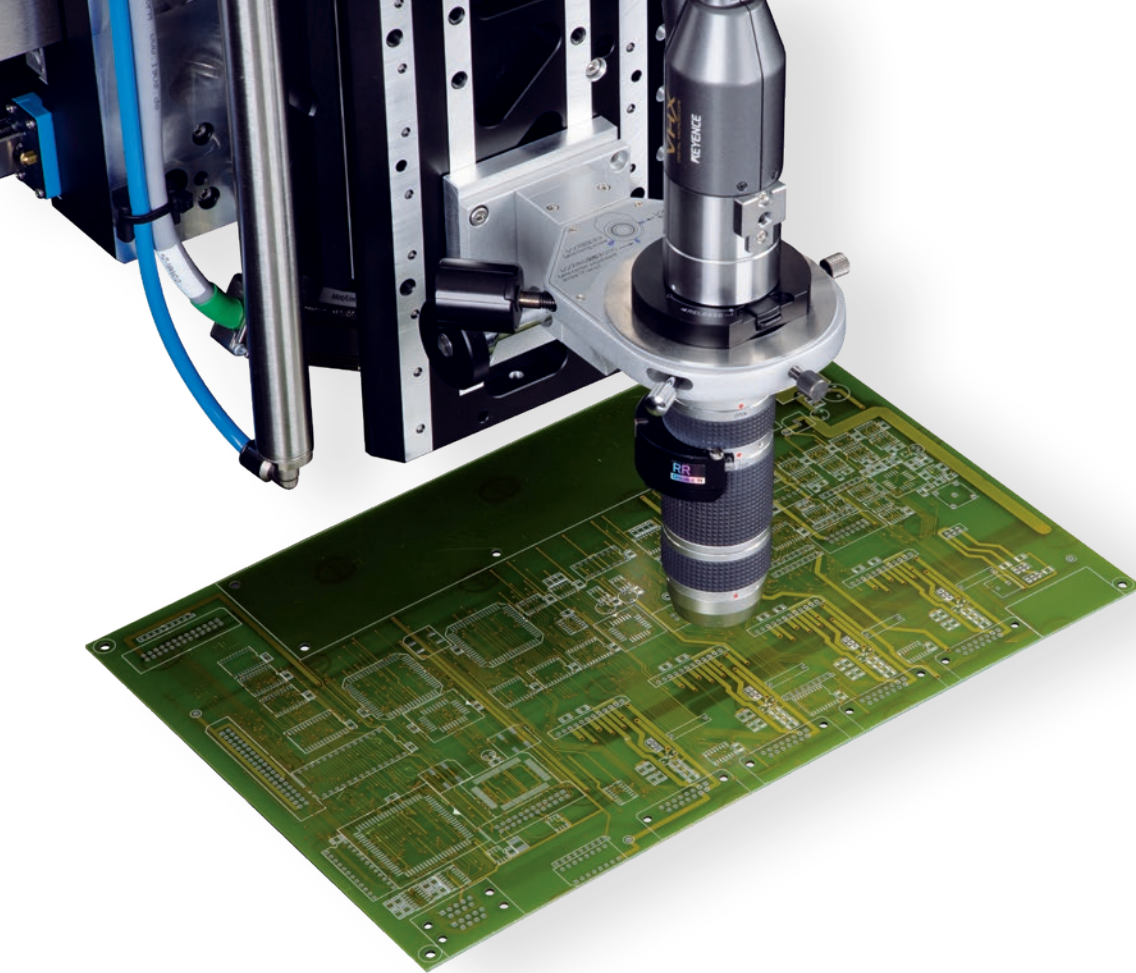

Motion Systems for Electronics Manufacturing

Industry 4.0, internet of things, cloud computing, autonomous driving, electronic health, augmented reality or artificial intelligence benefit from advanced technology that the semiconductor and electronics industry are currently making available. At the same time, these growing markets are presenting them with great challenges: Even smaller components with higher functional density, shorter innovation cycles, and a growing diversity of end products.

Precision, throughput, reliability, and flexibility of production systems is becoming more decisive at a wafer and chip level not to mention at printed circuit board level. Each positioning solution for placing, aligning, processing or inspecting components must be able to meet these requirements.

Process type, work cycle, tool types, size of the machining surface, feature size, and criteria such as throughput, precision and geometric tolerances make different demands on the motion systems.

Many years of experience in the semiconductor market, the technological diversity and the high vertical range of manufacturing enables PI to react flexibly to the market development and offer motion systems that address the needs of OEMs, integrators and end users in the field of electronics manufacturing.

This brochure contains examples of high-performance systems for different production steps from standard products to highly customized solutions that communicate via standard industrial networks.

Content

Automation Platforms for Placing.....	3
Automation Platforms for Aligning.....	4
Automation Platforms for Processing.....	5
Automation Platforms for Inspecting.....	6
Automation Platforms for Testing.....	7
Engineered Gantry Systems.....	8
Parallel-Kinematic Systems.....	10
Rotation Stages.....	12
XY Stages.....	14
Tip/Tilt Platform & Objective Scanner ...	17
Linear Stages.....	18
Z Stages.....	23
Linear Actuators.....	24
Motion Control.....	26
Capabilities of the PI Group.....	29

Placing Components and Tools

High Accuracy → High Dynamic → Long Travel Ranges

Manufacturers of electronic components are pushing for improved throughput. They can take advantage of the gantry's high speed but also its high accuracy for pick and placement of components and machining tools in continuous production. Reliable performance with high operating cycles is also important. PI's motion platforms meet these requirements and also provide easy connectivity to other automation systems and devices within the production line.

Key Features of the Gantry Design

- High mechanical stability
- Lightweight motion platform/bridge axis
- Disturbance rejection
- Individual travel ranges in XY up to 2 m
- Risers/lifters to place the vertical axis at required processing height
- Motion profiles may be raster based or a complex contour

Vertical Axis – Component and Tool Positioning

- PIMag® linear motors with pneumatic counterbalance
- Additional options for high-performance ballscrews with linear encoders
- Optimized cable management and operation for placing vertical motion axes, sensor and electronics integration, pneumatic lines and optical routing systems

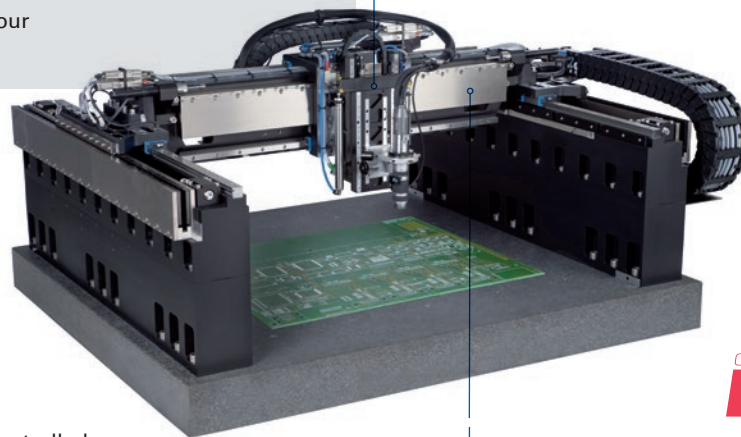

Controlled by

Motion Control

The gantry system can be controlled by an ACS motion control module which has:

- Multi-input multi-output optimization for yaw and linear control (MIMO)
- Automatic cross-axis tuning for consistent performance over all gantry areas
- Input shaping for vibration-free motion and vastly improved move and settle times >> p. 26 et seq.

XY Axis – Workpiece Positioning

- Base axis: Dual PIMag® linear motors for high dynamics and high precision >> p. 15
- Bridge axis optionally with air bearings for demanding straightness and velocity requirements >> p. 21

FURTHER SOLUTIONS FOR PLACING



High speed placing of ICs on test handler systems >> p. 24



Customised IC component packaging systems >> p. 9



Fast step and settle XY stages for ball grid array placement >> p. 14

Aligning Fibers and Optical Components

Fast Coupling → High Precision → Scan Routines

Universal adoption of smartphones, cloud computing, streaming media, E-Health and now the Internet of Things, and Industry4.0 all mean that more data must be stored, conveyed, and processed at higher speeds and with lower energy consumption. This is driving rapid integration of photonic devices alongside microelectronics on the same semiconductor wafers. Since testing begins at the wafer level, photonic techniques have been integrated into wafer probers and other semiconductor test tools. And the chips must be packaged together with other devices such as lasers and fiber arrays. Many of these manufacturing steps start with fast, non-contact and stable 6-DOF orientation of photonics elements to nanometer precision, with real-time compensation of drift, and photonic and geometrical variations.

Key Features of the Multi-Robot Active Alignment System

- Fast algorithms for first light, area scan, and gradient search for optimizing multiple elements, channels, inputs and outputs simultaneously
- Suitable for any optical figure-of-merit: power, photon count, MTF score, etc.
- Position sensors on all axes for high accuracy, safety, and reliability
- Optimization time typically less than 1 second



XYZ axis – Nanometer Positioning of Optical Components

- Parallel-kinematic piezo system for fast scanning motion and dynamic, real-time compensation of drift
 >> P-616 NanoCube®, p. 11

Motion Control

High-performance industrial controllers automate built-in scans and optimizations in parallel, with millisecond responsiveness to align the optics
 >> C-887 / E-712, p. 26 et seq.

Software

Support rapid application development on all common operating systems such as Windows, Linux, and MacOS as well as a large number of common programming languages including MATLAB, Python, C# and NI LabVIEW

XYZ/0_x0_y0_z – Submicron Automatic Optimization of Optical Components

- Parallel-kinematic hexapod micro-robots for motion and alignment in six degrees of freedom
- Freely definable center of rotation addresses geometrical offsets
- Brushless DC motors for industrial-class reliability
 >> H-811, p. 10

FURTHER SOLUTIONS FOR ALIGNING



Stacked multi-axis system for double-sided alignment of in- and output

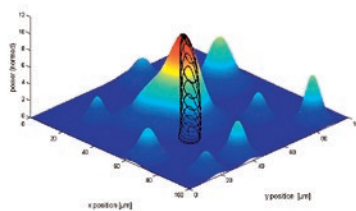

Fast automated alignment routines



Multi-axis system for single-sided fiber alignment >> p. 10

Processing Large Printed Circuit Boards

High Precision → High Throughput → Simultaneous Multidimensional Processing

Processing high-density structures over large areas such as laser drilling or laser marking of PCBs requires solutions which provide high precision and high velocities. A possibility to address the needs of industrial production is the coordination of multi-axis positioning systems with a high-dynamic galvanometer scanner. PI's simultaneous control of the XY stages and the excelliSCAN galvanometer scan system combined as XL SCAN allows continuous operation over large areas avoiding idle time and eliminating stitching errors. The ability of extending the field of view by the travel ranges of the stages has the advantage that the optics can be fixed and maintained in terms of accuracy, spot size and performance.

Key Features of the XL SCAN Automation Solution

- Extra large field of view
- Increased throughput (up to 41 %)
- Increased processing accuracy
- Elimination of the potential discontinuities caused by tiling or stitching multiple fields of view of the scan head
- Smooth processing with high dynamics and no stage vibrations



Galvanometer Axis – Fast Laser Positioning

- Fast and precise excelliSCAN scan system from SCANLAB with two galvanometer scanner axes for beam control

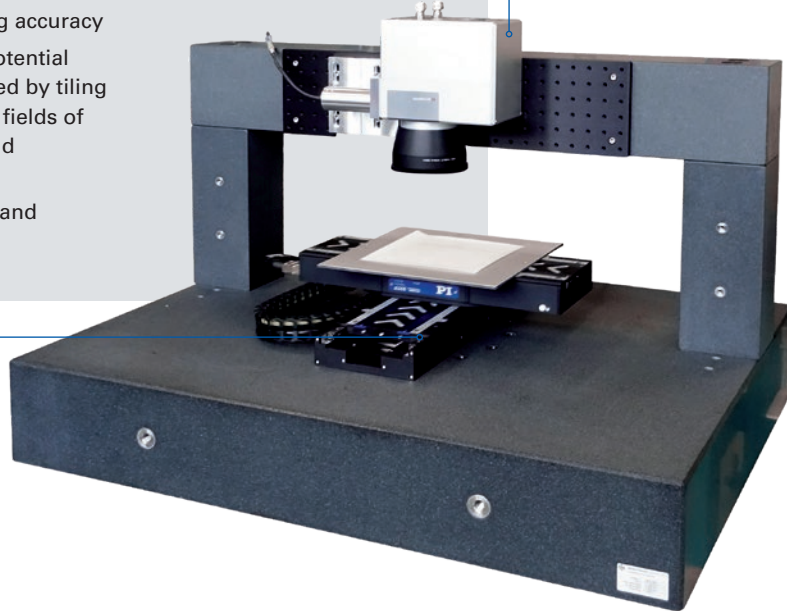

XY Axis – Workpiece Positioning

- PIMag® linear motors for high precision and high velocity >> V-551, p. 19
- Linear guides with crossed roller bearings
- XY drag chain cable management
- Granite base for optimized system accuracy

Motion Control

Class leading digital scanner technology with EtherCAT® based industrial networking. A patent pending coordination of SCANLAB's scan head control with the linear stages managed by an ACS motion control system.

FURTHER SOLUTIONS FOR PROCESSING



Air bearing systems for wafer dicing >> p. 13



XY stages for laser processing >> p. 18

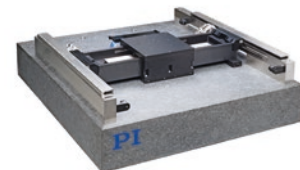

Granite-based systems for large area panel processing >> p. 15

Inspecting Complex Structures

Compact Design → High Stiffness → Multiple Degrees of Freedom

Electronic devices may be found on many complex structures such as concave or convex 3-D geometries. With the increase of 3-D printing and laser direct structuring, inspection of smartphone antennas, molded interconnects, wearable, and medical implants plus sensors have become widespread. The ability for rapid point-to-point inspection of components in such devices in a 24/7 environment is becoming more challenging. Hexapods are now being widely used for continuous scanning of surfaces in industries producing high-end optics, camera modules and automobile vision systems.

Key Features of Hexapods

- Three linear axes, three rotational axes
- High stiffness
- Low moving mass, low inertia
- Excellent dynamic behavior, fast step-and-settle
- Minimized axis crosstalk motion
- Excellent repeatability
- Small installation space
- Large central aperture
- No moving cables

Motion Control

- Position input via Cartesian coordinates
- Coordinate transformation handled by the controller
- Reference system (work, tool) can be quickly and easily changed
- Support of motor brakes and absolute-measuring sensors with BiSS interface
- Easy integration in automation processes via industrial EtherCAT® interface >> p. 26 et seq.



XYZ/0_x0_y0_z – Workpiece or Tool Positioning

- Multiple degrees of freedom
- Freely definable center of rotation of workpiece or inspection device
- Scanning of complex structures
- Ideal for spherical and aspherical shapes and freeforms such as optics



Have a look at the systems in motion on the PI YouTube channel www.youtube.com/user/phyinst

FURTHER SOLUTIONS FOR INSPECTION



R-Theta system for wafer scanning surface inspection >> p. 21



Autofocus inspection for analyzing defects >> p. 17



Large aperture XY stage for double-sided PCB inspection >> p. 14

Tactile and Optical Testing of Electronic Devices

High Repeatability → Force Control → Various Angles

Electronic systems are becoming smaller, more complex, operate in different environments and include several types of devices that require tactile, optical, and electronic testing methods. The position of these devices in the final assembly demands precise positioning of the inspection tool in several degrees of freedom. PI offers powerful motion systems for various test methods that can be integrated into customer production lines while maintaining capacity and throughput.

Key Features of PI's Motion Systems

- Unique range of motion technologies to design most advanced solutions
- EtherCAT® communication for fast and coordinated motion ensuring the highest throughput
- EtherCAT® connectivity for the integration of third-party sensors and test devices directly into the subsystem and into the external PLC or automation controller

Secondary Vertical Axis – Force Control of Measuring Sensor

- PIMag® voice coil linear actuator
- Force sensor with 1 mN resolution
- Weight force compensation >> V-275, p. 24

Motion Control

EtherCAT® control and synchronization of all axis types. External PLC control possible >> p. 26 et seq.

Vertical Axis – Positioning of Testing Device

- Ball screw linear motor or voice coil stage
- Cable management integration
- Holding brake or counterbalance
- Direct-measuring linear encoder >> M-511, p. 20

Hexapod Axis – Sensor Positioning at Various Angles

- Parallel-kinematic hexapod
- Six degrees of freedom
- Freely definable center of rotation >> H-811, p. 10

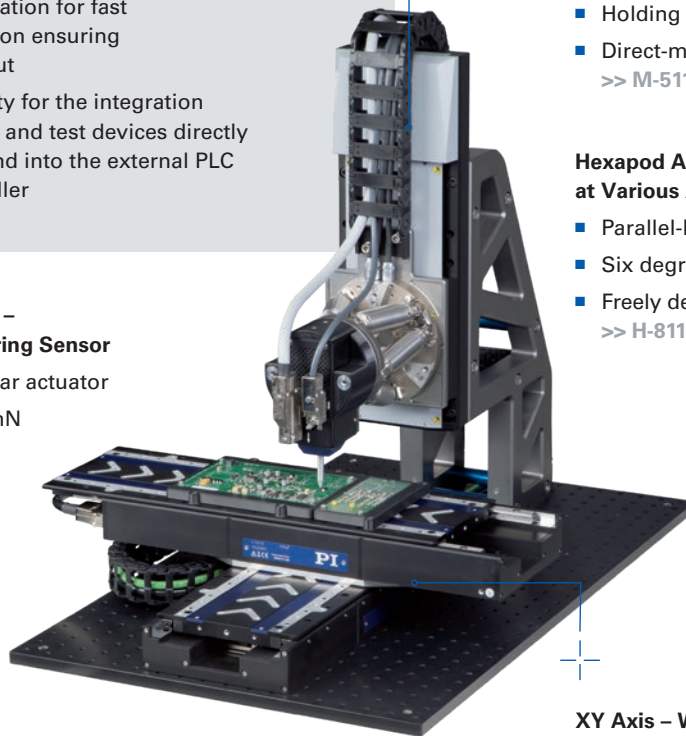

XY Axis – Workpiece Positioning

- PIMag® linear motors for high precision and high velocity >> V-551, p. 19
- XY drag chain cable management

FURTHER SOLUTIONS FOR TESTING



Inertial sensor testing – accelerometers, inclinometers & gyroscopes >> p. 12



Force sensor for haptic testing of devices >> p. 24

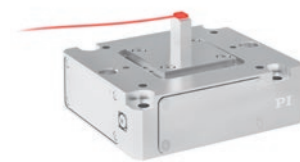

XY piezo system for ASICs testing >> p. 16

Engineered Gantries and Granite-Based Systems

Highly Dynamic – High Mechanical Stability – Customized Integration

Engineering designs of motion subsystems have been a part of PI's core business for many years. Customized solutions, fitting seamlessly into existing processes, advance automation in manufacturing and inspection processes.

Core Competencies

- Support and consulting for motion and positioning applications
- Economic design
- Complex multi-axis designs and parallel kinematic robotics
- Broad spectrum of in-house technologies: Drive, guide, and sensor technologies
- In-house development of motion control electronics and software platform
- Software support with libraries and drivers
- Commissioning

Gantry designs and other granite-based subsystems provide solutions for all steps of the manufacturing process from device or tool placement to final inspection and testing. Solutions may offer the ability to carry out multiple phases of the manufacturing cycle. PI can pull on its extensive expertise in engineering design to offer mechanical bearing, air bearing, and hybrid solutions. Extensive use of linear motor technology coupled with advanced motion control algorithms optimizes speed, step-and-settle profiles, and stability.

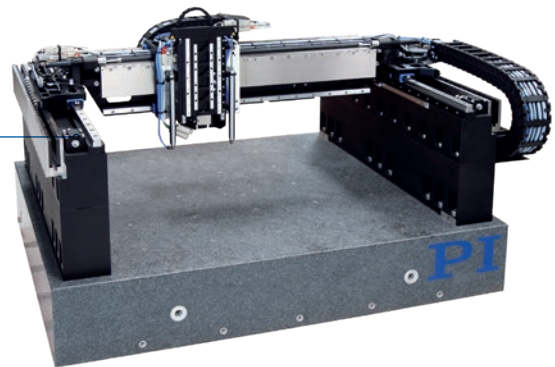

Mechanical Bearing Gantry System with Optional Z Axis



Applications: Stencil cutting · Pick-and-place · Processing · Micromachining · Alignment and inspection · Laser direct imaging

System features: Micron-level precision · High throughput · Ability to maintain the highest performance and stability over large XYZ areas



Planar Air Bearing with Additional Air Bearing Rotation Axis



Applications: Flat panel processing · Laser scribing · Wafer dicing and inspection

System features: Highest level of flatness, straightness and orthogonality · Integrated granite surface

Mechanical Bearing with Twin Cross-Axis and Multi Technology Ancillary Axis

Applications: Alignment and packaging
System features: Multiple tool heads provide flexibility and throughput, allowing numerous nests or stations to be operated concurrently

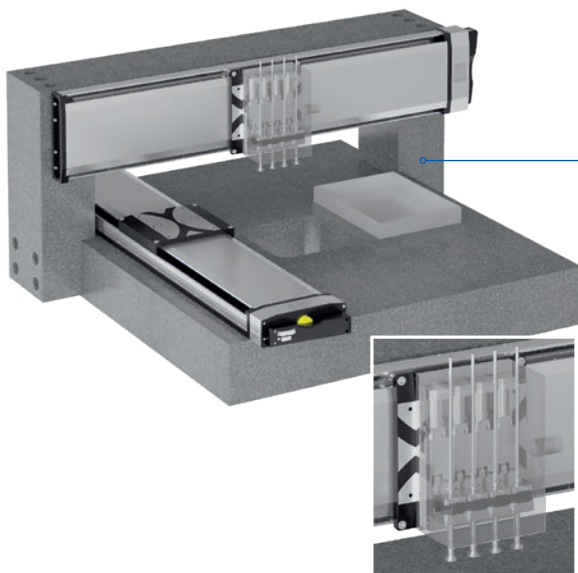
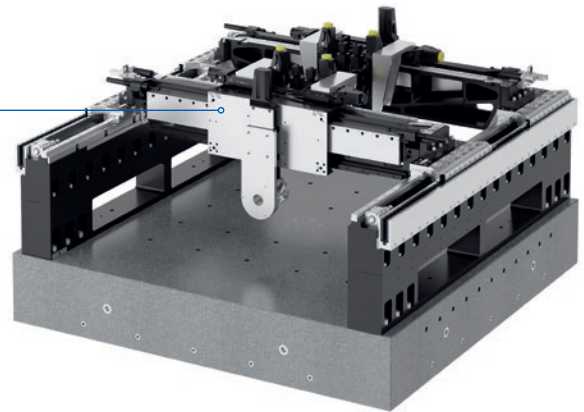

Long Linear Travel on a Split-Bridge Granite Arrangement

Applications: Alignment and packaging
System features: Substrate feeder and component carrier · Fast repeatable motion · Head provides 4 simultaneous placements · Hollow shaft allows vacuum feed-through for component gripper



Hybrid Bearing Design with Air Bearing Scan Axis and Ball Bearing Step Axis

Applications: Wafer inspection and processing · 3-D printing
System features: Fast step axis with additional pitch stiffness of mechanical bearing · High degree of velocity, flatness, and straightness on scanning cross axis

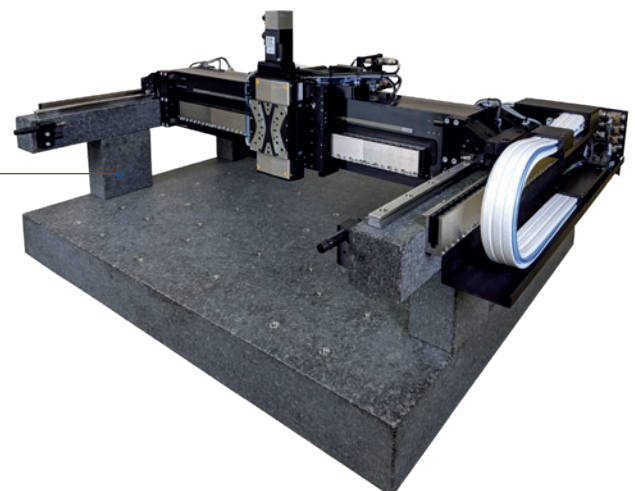

Have a look at further engineered subsystems on the PI website www.pi.ws

Parallel-Kinematic Hexapods

High Stiffness – Free Definable Pivot Point – Compact Design



H-811.I2

- Travel ranges to ± 17 mm / $\pm 21^\circ$
- Load capacity to 5 kg
- Repeatability to ± 0.06 μ m
- Velocity to 20 mm/s
- Superior lifetime



Applications: Inspection and testing of aspherical or spherical surfaces · Alignment of components and camera lenses · Sensor testing · Limited installation space

System features: High stiffness · Multi degrees of freedom · Compact design · Low abbe error · Submicron precision

- Load capacity to 30 kg
- Travel ranges to ± 50 mm / $\pm 30^\circ$
- Repeatability to ± 0.1 μ m
- Velocity to 60 mm/s
- BLDC motors and variants with absolute encoders
- Works in any orientation



H-840



Technology: Parallel-Kinematic Hexapods

In a parallel-kinematic hexapod all drives act on a single moving platform, which results in a much more compact design than possible with stacked systems. Compared to a serial robot, hexapods show a much better ratio of payload to operating weight. As only one platform is moved, the overall moved mass is lower resulting in higher dynamics in all motion axes. Serial motion and positioning platforms have their advantages in the high modularity which allows for individual design of each moving axes. Motion control, especially the homing procedure, is simpler with no coordinate transformation required. On the other hand, the combined positioning errors of stacked systems affect the attainable overall system accuracy. Hexapods can have an improved path accuracy, higher repeatability and flatness of travel.

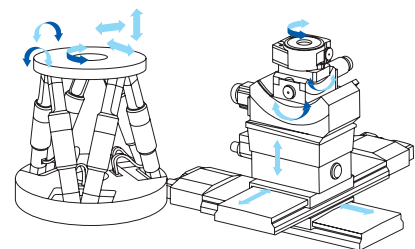

Parallel-Kinematic Multi-Axis Systems

High Stiffness – High Frequencies – Compact Design



Applications: Aligning and positioning of small devices in very fine scale and with high frequency · Fast Scanning

System features: Compact design for space-critical applications · High stiffness for high frequency adjustments · Superior multi-axis subnanometer performance in XYZ

- Parallel-kinematic XYZ piezo system
- Travel range 100 μm
- High resonant frequencies
- Resolution to 0.3 nm
- High guiding accuracy due to zero-play flexure guides
- ID chip functionality for fast auto-calibration
- Outstanding lifetime due to PICMA[®] piezo actuators >> p. 25

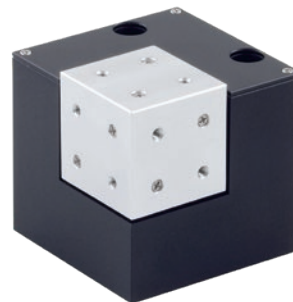

P-616 NanoCube[®]



Applications: Mask and wafer alignment · Inspection · Surface measurement by AFM

System features: High tracking accuracy · Fast scanning · Excellent flatness · Nanometer precision · Fast response times · Multiple degrees of freedom

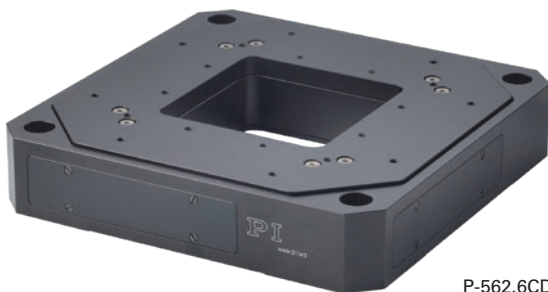

P-562.6CD PIMars

- Parallel-kinematic 6-axis piezo system
- Travel ranges to 200 μm linear and to 1 mrad tip/tilt angle
- Clear aperture 66 mm x 66 mm
- Highest linearity due to capacitive sensors
- High guiding accuracy due to zero-play flexure guides
- Excellent scanning flatness
- UHV-compatible to 10^{-9} hPa



From Standard to Custom Products

PI offers different solutions for applications requiring multi-axis precision alignment based on serial kinematics (stacked axis), parallel kinematics (e.g. hexapods), and hybrid kinematics (SpaceFab), which comprise 3 sets of stacked xy stages combined to a 6-DOF kinematics. Generally, PI technologies can be combined to a customized SpaceFab, fulfilling the customer's requirements on travel and precision. The use of linear motor technology with absolute encoders with 1nm resolution enabled PI to combine the speed and reliability required for high productivity in electronics assembly and component alignment, as well as for higher accuracy for dense packaging of the smallest components. Long travel in x and y as well as optimized flatness for applications requiring multiple-axis precision alignment can be achieved easily by SpaceFab hybrid kinematics.

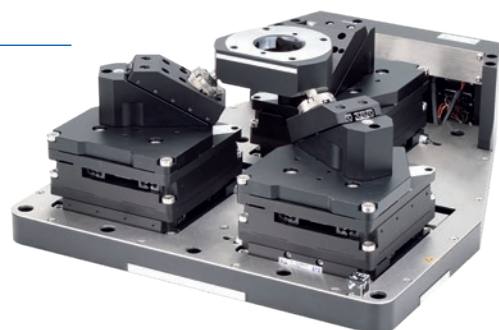

Hybrid SpaceFab for electronics assembly and alignment of components

Precision Rotation Stages

High Rotational Accuracy – Direct Position Measurement – Aperture



Applications: Micromanipulation · Alignment of optical components and gimbals
System features: High speed and high accuracy · Very low profile allows placement in space constrained areas · High torque to size ratio · Direct drive and direct position measurement · Keeps position at power off · Low noise emission

U-651

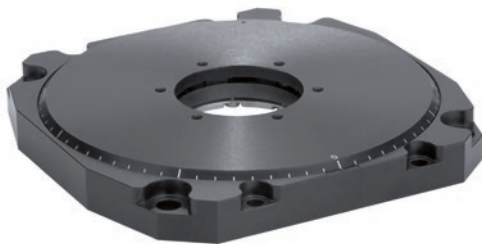

- PLine® ultrasonic piezomotor
- Low profile of only 14 mm
- Unlimited rotation range >360°
- Drive torque to 0.3 Nm in both directions of rotation
- Self-locking when switched off: Saves energy and reduces generation of heat



Applications: Alignment and testing of devices such as accelerometers, inclinometers and gyroscopes
System features: Low speed angular motion · Direct measuring capability to increase table top position accuracy · Aperture for component placement and access from underneath delivery

- Unlimited travel range
- Repeatability to 0.5 µrad
- Load capacity to 50 kg
- Option: Direct position measuring with angle-measuring system

PRS-200

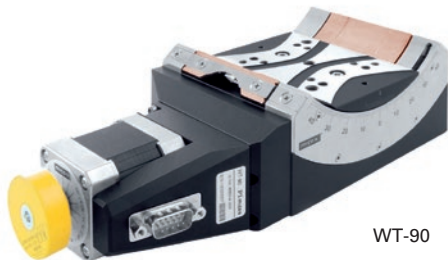
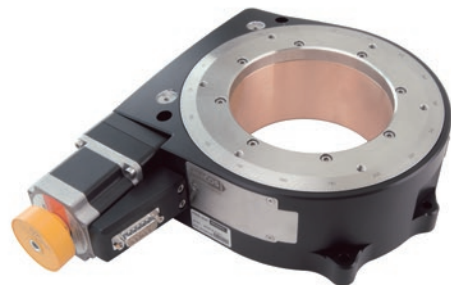

WT-90

- Rotation range 90°
- Repeatability to 2.7 µrad
- Load capacity to 8 kg
- Option: Direct position measuring with angle-measuring system



From Standard to Custom Products

Commercially available torque motors offer very high torque but only limited apertures. This customized PIMag® torque motor has a particularly large aperture and offers high dynamics and stability. It requires minimal installation space, for example it can be integrated on top of a PI hexapod without vastly increasing overall height.



High-Precision Air Bearing Rotation Stages

Exceptional Velocity Control – High Placement Accuracy – Aperture

- Unlimited travel range
- High load capacity
- Table top diameters from 50 to 300 mm
- Bidirectional repeatability $\pm 4 \mu\text{m}$
- Clear aperture
- Optional absolute encoder
- Slip ring options
- Cleanroom compatible



A-62x series



Applications: High-precision alignment and calibration of sensors · Wafer inspection
Metrology applications · X-ray diffraction systems

System features: High accuracy of position even during multi-axis contouring · Low profile and weight to reduce errors associated with working height · Elimination of cogging for smooth velocity control · Direct measurement at table top position · Aperture for component placement or beam delivery



- XY air bearing stage >> A-311, p.15
- Air bearing rotation stage >> A-623
- Air bearings on all axes
- Full-load support over complete XY travel range
- High system repeatability and flatness
- Drag chain cable management included
- Metrology provided at wafer work point

Stacked system configured from standard products for surface inspection and wafer dicing



From Standard to Custom Products

For measuring thickness and flatness of wafers a customer required a rotation stage with very smooth motion and low error motion (runout and wobble). Also, there should be an access to both the top and bottom surfaces of the wafer. PI were able to take their experience and create a design with a very large aperture relative to outer diameter, whilst maintaining the original important characteristics of an air bearing rotation stage.

- Clear aperture with 260 mm diameter
- Radial/Axial error motion < 100 nm
- Non contact and frictionless
- Max. velocity to 3.000 %/s
- Cleanroom compatible

High-Precision XY Linear Motor Stages

High Precision Scanning – Exceptional Geometric Precision – High Accuracy



Applications: Alignment and inspection of wafers and PCBs · High precision metrology applications · LED wafer processing · Applications where straightness and flatness of motion is critical
System features: High-precision contouring or raster scanning · Nanometer resolution · Aperture versions for processing from top and bottom and feed through

- Travel range 102 mm x 102 mm (4")
- Large aperture, 150 mm x 150 mm
- Bidirectional repeatability to $\pm 0.25 \mu\text{m}$
- Velocity to 500 mm/s
- PIMag® linear motor >> p. 15
- High-resolution incremental linear encoder

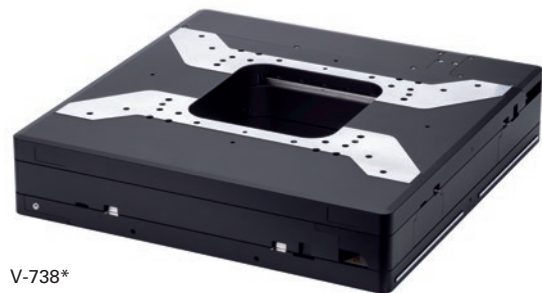

V-738*



V-731 · V-741*

- Travel range 205 mm x 205 mm (8"), 305 mm x 305 mm
- Bidirectional repeatability to $\pm 0.25 \mu\text{m}$
- Velocity to 200 mm/s
- Incremental linear encoder with 1 nm resolution
- PIMag® linear motor >> p. 15
- Crossed roller guides, anti-creep

* Also available with stepper motor or DC motor



From Standard to Custom Products

All essential technologies required for the drive or motor, the measuring system, the motion controller, and the guiding system, are available in-house at PI. To serve custom requirement, in-house development and the production capabilities of PIMag® magnetic drive technologies can be utilized.

Here is an example of a modified XY stage with PIMag® linear motors. The customer required shorter processing times, higher precision at high duty cycles, and improved accuracy while adding a higher mass workpiece. In order to achieve these requirements, a new stage was developed based on the experience with PI standard stages such as the V-741. The new stage is designed with increased power ironless linear motors to offer higher accelerations and lower heating.

The newly designed body of the stage is more rigid providing higher stiffness, improved straightness and flatness with the use of higher loads. In addition the use of an absolute encoder enables the customer, to simplify startup and improve throughput of the machine.



- Travel range 305 mm x 305 mm (12"x12")
- Max. velocity 1000 mm/sec
- Load capacity up to 30 kg
- Absolute optical encoder
- Encoder with BiSS C communication
- ACS Motion Controller >> p. 26 et seq

Ultra-High Precision XY Air Bearing Stages

High Precision Scanning – Exceptional Flatness – High Accuracy



Applications: Wafer inspection and processing · Laser micromachining and laser ablation where ultimate precision with long-term repeatable processing is required · Scanning applications · Demanding metrology
System features: Exceptional flatness, straightness and orthogonality for correct feature shapes and two-dimensional placement · Outstanding velocity regulation for scanning and constant velocity tasks

- Travel ranges to 200 mm × 200 mm
- Load capacity to 147 N
- Low profile
- Bidirectional repeatability $\pm 0.1 \mu\text{m}$
- Air Bearings >> p. 21
- Optional granite base plates
- Cleanroom compatible

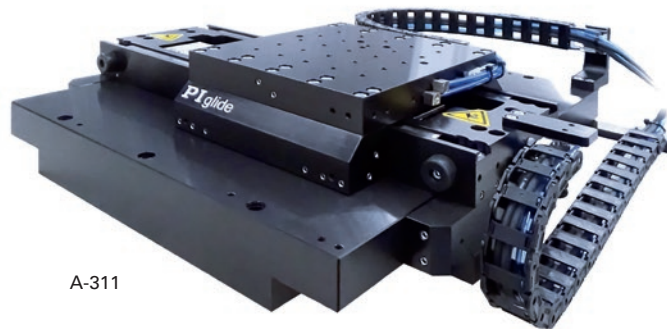

A-311



Applications: Flat panel processing · Laser scribing · Wafer dicing · Thin film patterning
System features: Highest level of flatness, straightness and orthogonality

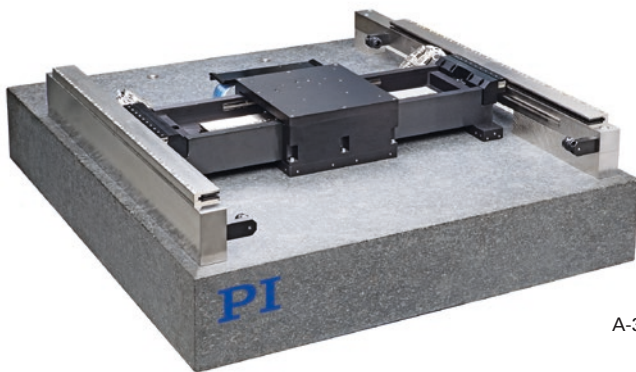

A-322

- Travel ranges to 500 mm × 1000 mm
- Load capacity to 245 N
- Bidirectional repeatability $\pm 0.08 \mu\text{m}$
- Air Bearings >> p. 21
- Velocity up to 2 m/s
- Cleanroom compatible



Technology: PIMag® Linear Motors

Magnetic direct drives from PI provide a direct and stiff connection between the load to be moved and the drive. The industry demand is particularly high when objects need to be positioned with high dynamics and precision. In conjunction with the smooth-running precision air bearings, these types of linear systems are particularly suitable for applications that require constant-velocity scanning. The drives operate without mechanical contact and therefore are very reliable. PIMag® linear motors are the result of in-house development. In this way, specific properties of the stages can be influenced directly.

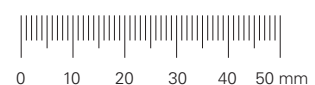
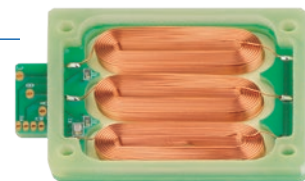

High-Precision XY Piezo-Based Stages

Fast Scanning – Direct Position Measurement – High Accuracy



Applications: High-speed alignment of optical components · Dynamic correction of system errors · Fast surface scanning of sensors

System features: Fast motion with nanometer precision · Excellent linearity · Low position noise

- PIHera piezo system
- Travel ranges 50 to 1800 µm
- Repeatability to ±2 nm
- Positioning accuracy 0.02 %
- Direct metrology with capacitive sensors
- Outstanding lifetime due to PICMA® piezo actuators >> p.25

P-620



Applications: Fast and precise scanning and stitching for microscopy applications

System features: Nanometer precision · High Dynamic · Self-locking on power off · Low profile · Low noise

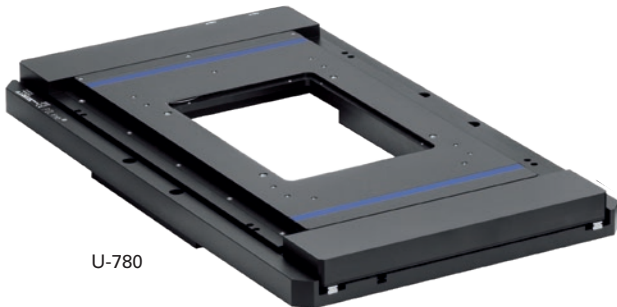

U-780

- PLine® ultrasonic piezomotor
- High velocity constancy at 10 µm/s
- Velocity to 120 mm/s
- Bidirectional repeatability ± 0.3 µm
- Travel range to 135 mm × 85 mm
- Compact, flat design: Unrestricted access to the sample



From Standard to Customization: Active Alignment of Optical Interfaces

The maximum performance of PI precision systems is achieved through comprehensive design and analysis know-how using proprietary techniques and proprietary devices developed in-house. The image shows a customized piezo-based XY stage for a HVM (High Volume Manufacturing) test assembly for ASICs (Application Specific Integrated Circuits). The test platform is part of an IC pick-and-place handler machine. The micrometer accurate positioning system aligns the optical interface and the DuT (Chip under Test). It enables scanning of more than 100 µm in x and y direction on the chip in less than 1s. Path trajectory and scan area can be adjusted according to the individual DuT.

The XY system is retrofitted into the existing pick-and-place change KIT and is equipped with a mechanical device to fix the optical interface and an aperture for chip handling using the existing vacuum suction.

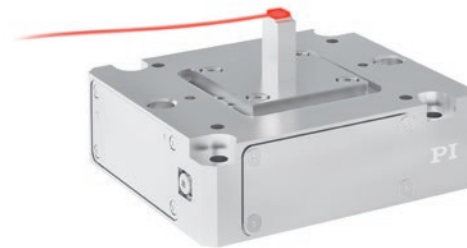

- 110 µm travel range in x- and y-direction
- Scanning in open-loop with signal threshold detection
- Frictionless, high-precision flexure guiding system
- Temperature compensated
- Individual optical mountings
- EtherCAT® controller >> E-727, p.26 et seq.

Tip/Tilt Platform and Objective Scanner

High Dynamic – High Guiding Accuracy – Outstanding Lifetime



Applications: High-speed laser deflection · Beam alignment and positioning on very fine scale
System features: Compact design for space critical applications · High stiffness for high frequency adjustments · Self locking · Superior multi-axis subnanometer performance



S-331

- Parallel-kinematic tip/tilt platform
- Tip/tilt angle up to 5 mrad, optical deflection angle up to 10 mrad (0.57°)
- High resonant frequencies for dynamic motion and fast step-and-settle
- Position sensors for high linearity
- Outstanding lifetime due to PICMA® piezo actuators >> p. 25



Applications: Surface profilometry (wafer lapping and polishing) · High-resolution imaging (semiconductor, MEM, and LED devices) · Auto-focusing · Scanning interferometry (thin films) · Confocal scanning (wafer bump and through-silicon via) · Laser machining optics
System features: Focusing and Z-stack scanning · Zero-play · Fast step-and-settle operation · Sub-nm resolution



P-725 PIFOC®

- PIFOC® objective scanner
- Travel ranges to 460 µm
- Settling times in the range of milliseconds
- Fine positioning of objectives with sub-nm resolution
- Highest linearity due to capacitive sensors
- Zero-play, high-precision flexure guide system
- Outstanding lifetime due to PICMA® piezo actuators >> p. 25



From Standard to Custom Products: Autofocus System

Autofocus systems with PIMag® voice coil drive are used in the automated inspection for analyzing defects and reviewing dimensions of wafers. The autofocus system is used to map the wafer surface, which is then passed to the inspection system to automatically adjust the focus during the inspection process. PI not only provides the voice coil stage but also the tools and application support to correctly align the customer's objective lens with the direction of travel thus ensuring total system performance.



Precision Linear Motor and Ball Screw Stages

High Load – Long Travel Ranges – Cost Efficient



Applications: Processing, alignment and metrology applications in industrial environment
System features: Single-axis, XY and Z configurations · High repeatable accuracy · Long-term performance · Vertical positioning of loads · Medium Speeds · Robust build

- Travel range to 813 mm
- Velocity to 300 mm/s
- Synchronous servo motor
- Precision recirculating ball bearings, load capacity to 400 N, to 450 N
- Side seal and air purge
- Optional holding brake
- Optional linear encoder to improve repeatability and accuracy

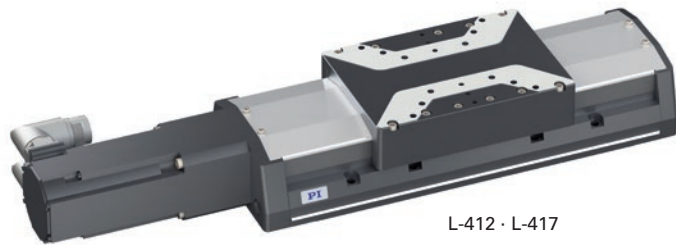

L-412 · L-417



Applications: High industrial performance · Reliable tasks for processing, alignment and metrology applications · High-speed die bonding
System features: Single-axis and XY configurations · High accuracy · High velocities · Long-term performance

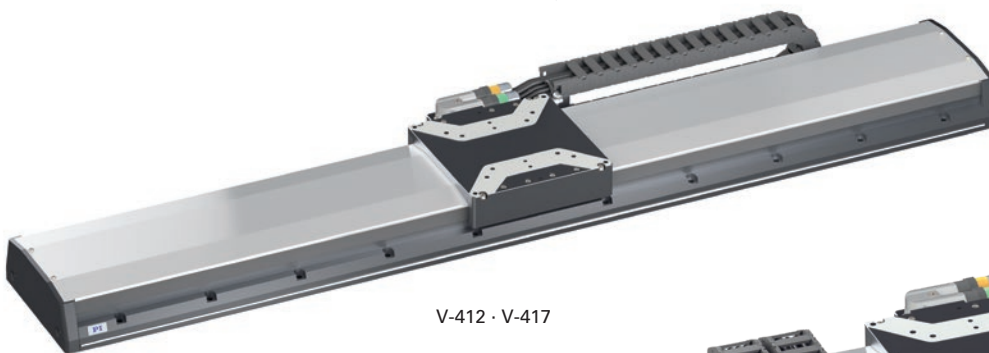

V-412 · V-417

- Travel ranges to 813 mm
- High nominal force 33 N, 87 N
- Velocity to 2000 mm/s
- PIMag® linear motor >> p.15
- Precision recirculating ball bearings, load capacity to 400 N, to 450 N
- Side seal and air purge
- Drag chain cable management



XY configuration of the V-417

High-Precision Piezo-Based and Linear Motor Stages

High Accuracy – High Dynamic – Flexible Configuration



Applications: Micromanipulation · Automated alignment of optical components or samples · Applications with limited space

System features: Single-axis, XY and Z configurations · Self-locking on power off · Fast motion with nanometer precision · High force to size ratio · Low noise emission

- PLine® ultrasonic piezomotor
- Velocity to 200 mm/s
- High guiding accuracy
- Bidirectional repeatability $\pm 0,2 \mu\text{m}$
- Self-locking, no heat generation at rest
- Low-noise operation



U-523



Applications: Ultrafast micromachining and nanofabrication · Rapid part and tool alignments · Metrology and scanning

System features: Fast and precise scanning · Compact design · Nanometer precision · Excellent geometric performance · Outstanding velocity control



V-522 · V-524 · V-528

- PIMag® voice coil with direct positioning measuring
- Travel ranges 5 mm, 10 mm, 20 mm
- Max. velocity 250 mm/s
- Bidirectional repeatability $\pm 120 \text{ nm}$
- Scanning frequencies of more than 10 Hz
- Crossed roller bearings, anti creep

- PIMag® linear motor >> p. 15
- Travel ranges to 230 mm
- Velocity to 0.5m/s
- Bidirectional repeatability $\pm 0.05 \mu\text{m}$
- High guiding accuracy
- Crossed roller guide, anti creep
- Highest precision with >> PIONe linear encoder



V-551



Technology: PIONe Linear Encoder

The high-resolution PIONe encoder was developed by PI and, with corresponding processing of the measured values, allows a position resolution considerable less than one nanometer. The optical and noncontact PIONe encoders are based on an interferometric measuring principle. Due to the short signal period and the high quality of the signals, the linearity error of PIONe encoders is less than 1 %. PIONe encoders support direction sensing when evaluating a reference signal. A V-551.4D with PIONe linear encoder performs a sequence of 0.5-nm steps.

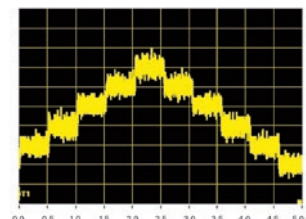

High-Precision Ball Screw Stages

High Travel Accuracy – Compact Design – Cost Efficient



Applications: General purpose · Processing of heavy loads
System features: High precision at medium travel ranges and low speed · Z-axis configurations · Low profile

- Travel ranges 102, 204, and 306 mm (4", 8", 12")
- Max. velocity to 100 mm/s
- Bidirectional repeatability $\pm 0.2 \mu\text{m}$
- Load capacity to 100 kg
- Zero-play ball screw
- XY and XYZ configurations



M-511 · M-521 · M-531



Applications: General purpose · Processing of substrates · Vertical and horizontal tool, camera, or sensor centering · Die bonding
System features: High precision at medium travel ranges and low speed · Stiff · Resistant to jitter

L-408



- Travel range 25 mm
- Stepper motor, DC or DC gear motor
- Precision sliding-thread spindle
- Crossed roller guides for high load capacity and precision, anti-creep
- Integrated optical limit switches
- Optical reference point switch with direction sensing

L-511



L-509

- Travel ranges to 155 mm (6")
- Bidirectional repeatability to $\pm 0.1 \mu\text{m}$
- ActiveDrive DC, DC, BLDC, and DC gear motors
- Stepper motors
- Optional linear encoder for direct position measurement
- Direction-sensing reference point switch

Ultra-High Precision Linear Air Bearing Stages

High Guiding Accuracy – Exceptional Velocity Control – Long Travel Ranges



Applications: Inspection and processing of wafers and flat panels · Scanning · Laser scribing and drilling · 24/7 operation · Metrology

System features: Highest flatness, straightness, velocity and precision · Split bridge arrangements · Long-term performance · Cleanroom compatible

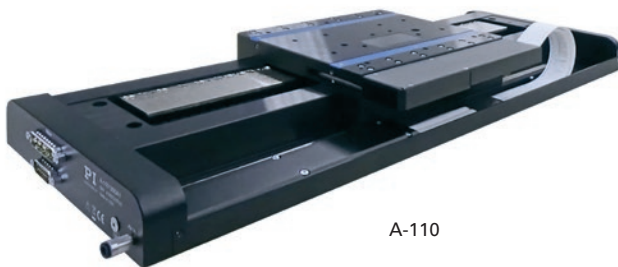

A-110

- Size of the motion platform 210 mm × 210 mm
- Travel ranges 50 mm to 750 mm
- Bidirectional repeatability $\pm 0.1 \mu\text{m}$
- Noncontact and friction-free motion
- Preloaded >> air bearings
- Cleanroom compatible

- Size of the motion platform 160 mm × 200 mm
- Travel ranges to 400 mm
- Bidirectional repeatability to $\pm 0.25 \mu\text{m}$
- Load capacity to 100 N
- Noncontact and friction-free motion
- Magnetically preloaded >> air bearings
- Cleanroom compatible

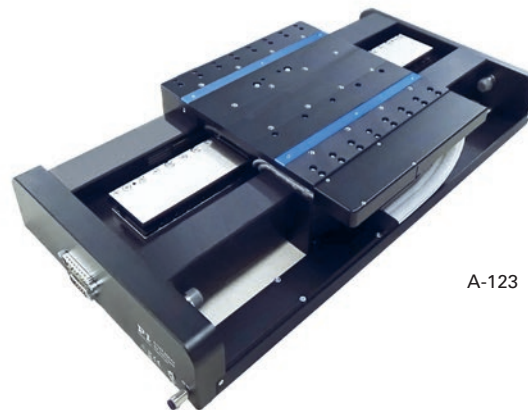

A-123



A-141

- Size of the motion platform 57 mm × 93 mm
- Bidirectional repeatability $\pm 0.1 \mu\text{m}$
- Load capacity to 3 kg
- Velocity to 0.25 m/sec
- Acceleration to 3.5 m/s^2
- Cleanroom compatible



Technology: Pliglide Air Bearing

The Pliglide air bearing technology allows friction-free positioning with exceptional on axis error motion accuracy of up to $5 \mu\text{rad}$ over 100 mm. The technology provides high in position stability and constant velocity scanning. Air bearings have straightness and flatness characteristics that are superior to mechanical bearing solutions.

High-Precision Compact Linear Stages

Very Compact Design – Cost Efficient – Flexible Configurations



Applications: Positioning of workpieces or optics

System features: High repeatable accuracy · Short travel ranges · Compact design



L-505

- Travel ranges 13 or 26 mm
- Stepper motor or DC servo motor with and without gearhead
- Velocity to 15 mm/s
- Bidirectional repeatability to $\pm 0.15 \mu\text{m}$
- Load capacity to 30 N

- Travel range 25 mm
- Integrated linear encoder option for highest accuracy with $0.1 \mu\text{m}$ resolution
- Unidirectional repeatability $0.15 \mu\text{m}$
- Max. velocity 20 mm/s
- Ball screw for high velocities and number of cycles

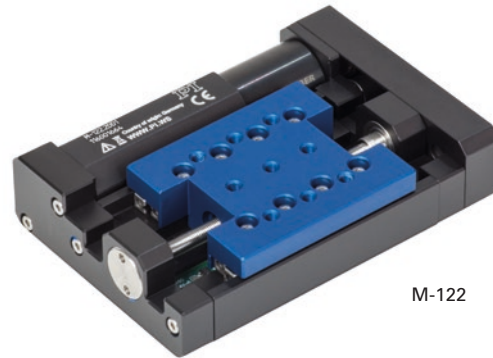

M-122

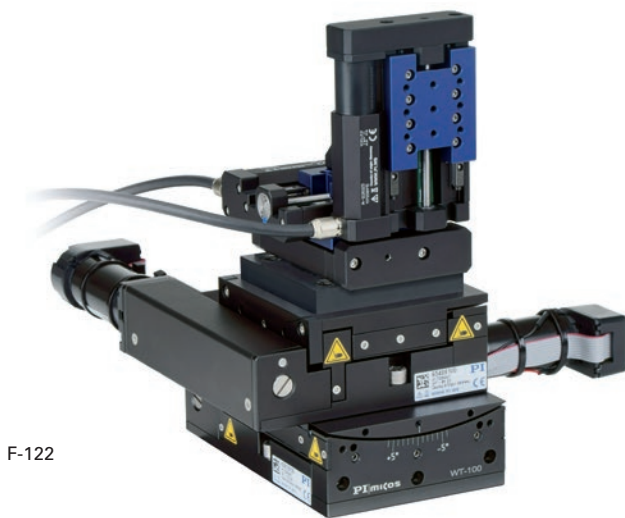

F-122

- Long travel ranges to 25 mm respectively 10°
- Maximum velocity of 20 mm/s respectively $15^\circ/\text{s}$
- Unidirectional repeatability XYZ $0.3 \mu\text{m}$
- Angle optimization by goniometer
- Safety due to integrated sensor technology

Stacked system configured from standard products for testing and packaging on chip level

Precision Z Stages

High Loads – High Stability – Highly Practical



Applications: Vertical part motion · Fine focus adjustments
System features: Unobstructed access to the table top from any direction

- Compact design: Surface 63 mm × 63 mm
- Stepper motors and closed-loop DC motors
- Optional linear encoder for direct position measurement
- Crossed roller guides, anti-creep
- Noncontact reference and limit switches

L-306



UPL-120



- Travel range 13 mm (1/2")
- Unidirectional repeatability to 0.05 μm
- Load capacity to 20 kg
- Integrated optical limit switches
- Available with direct-measuring encoder
- Crossed roller guide, anti-creep

Online Product Finder

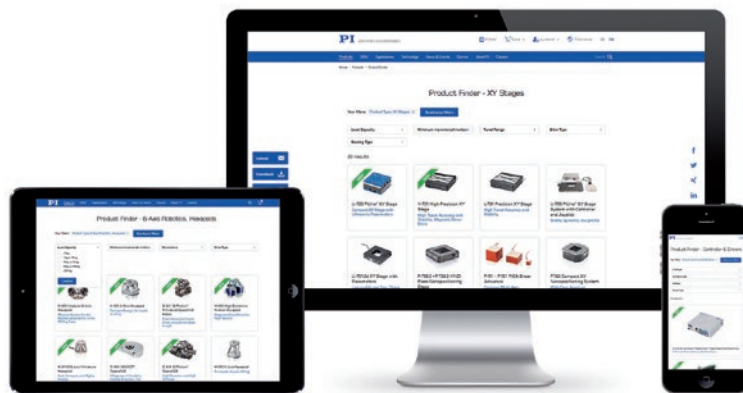

In addition to the brochure you can take advantage of the product finder on the PI website. It allows searching for a suitable automation solution specified by the axes of motion required.



Try out at www.pi-product-finder.com

Precision Voice Coil Linear Actuators

High Dynamic – High Velocity – Force Control



Applications: High speed placing of integrated circuits on turret-based test and finish handlers, chip shooter
System features: High speed and accurate motion · Compact design



V-900KPIC

- Travel range 1.5 mm
- High scanning frequencies, fast step-and-settle
- Integrated linear encoder with 0.1 μm resolution
- Compact dimensions
- OEM linear actuator

- Travel ranges to 20 mm
- Velocity to 100 mm/s
- Integrated linear encoder, 0.01 μm resolution
- Optional force sensor with 1 mN resolution



V-273



Applications: Haptic and touch screen testing · High speed device placement · Pressure and tension control

System features: Precise positioning and force feedback · Contour following based on force rather than displacement sensor · Dual feedback capable



V-275

- Push force up to 10 N
- Velocity to 600 mm/s
- Integrated linear encoder, 0.01 μm resolution
- Weight force compensation
- Optional force sensor with 1 mN resolution



Technology: Position and Force Control

Force regulation allows the operation of PIMag® drives and stages with defined holding or push/pull forces. The force and position sensors can be read individually or simultaneously in a dual control loop. The motor can not only operate in pure force control, it also maintains the ability to control both position and velocity. An auto-zero function defines the holding current at which the drive outputs an open-loop force of 0 N, i. e., for compensating weight.



Precision Screw-Drive and Piezo Linear Actuators

High Dynamic – High Resolution – High-Load



Applications: Aligning PCBs to masks · Micro jetting · High precision and low volume dispensing e.g. solder balls or solder paste · Component assembly

System features: Ability to move tiny distances to displace material (liquid or physical) · High repeatability · High forces · Compact design

- Forces up to 125 N
- Travel ranges 13 to 77 mm (.5" to 3")
- DC or stepper motor
- Nonrotating tip
- Vacuum-compatible versions to 10⁻⁹ hPa on request



L-220



L-239

- High feed force to 300 N
- Travel range 52 mm (2")
- Minimum incremental motion 0.1 μm
- Velocity to 50 mm/s
- Preloaded, low-friction ball screw
- Vacuum-compatible versions to 10⁻⁹ hPa on request
- Stepper, DC and BLDC motors

- Travel ranges to 1 mm
- Forces to 100 N
- Flexure guides
- Stiff and backlash-free construction
- Ideal OEM actuator
- Outstanding lifetime due to >> PICMA[®] piezo actuators

P-602

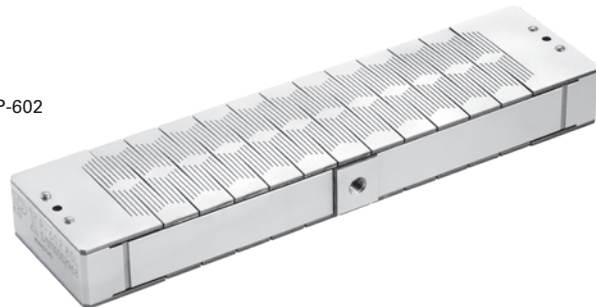

Technology: PICMA[®] Multilayer Piezo Actuators

PICMA[®] actuators take advantage of the indirect piezoelectric effect and achieve high forces. They only need a small amount of installation space. At the same time, the PICMA[®] actuators are very dynamic and can reach a position with an unprecedented precision. Due to their ceramic insulation, PICMA[®] actuators exhibit high reliability and climate resistance. After several billion cycles no signs of wear in performance were observed.

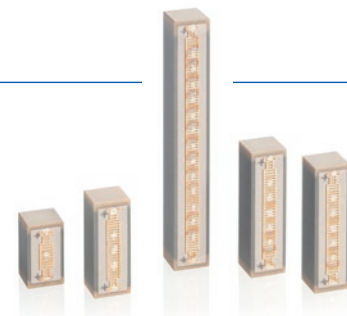

Industrial Motion Control

High Performance – EtherCAT® Communication – Highly Modular

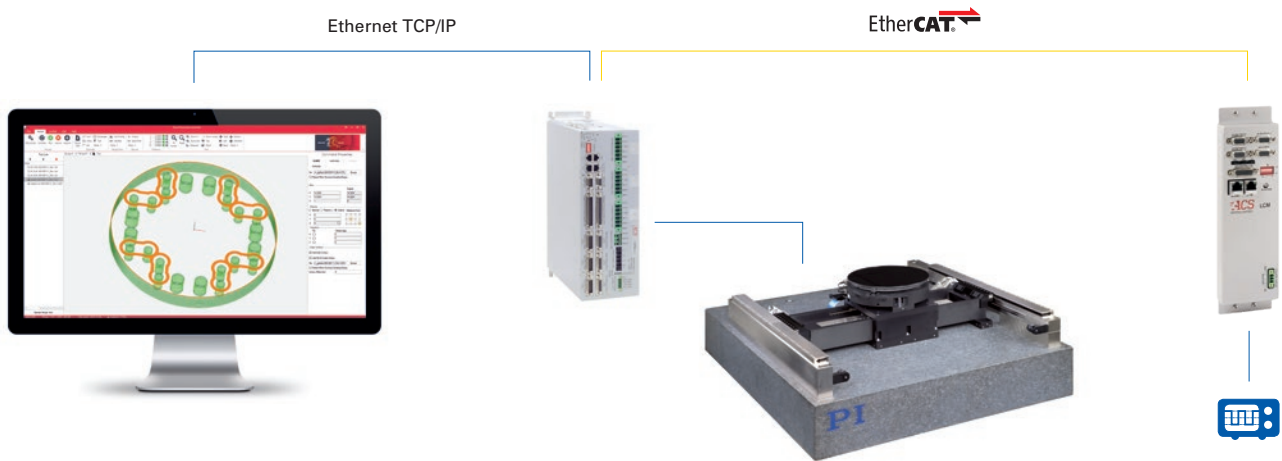

Key Features of the Control Solutions

- Modular hardware design
- EtherCAT®-based communications
- Open architecture for third party EtherCAT®
- Universal support of multiple motor and feedback types
- Functional safety drive inputs
- Input shaping for vibration-free motion
- Extensive trigger functionality
- 1, 2, and 3- axis dynamic error compensation
- Yaw compensation for gantry solutions
- HMI for CNC user operations
- .NET library support for windows based applications
- MATLAB library

The EtherCAT®-based ACS motion controllers, drive modules, and drive interfaces are ideally suited for multi-axis synchronized motion applications with the capability to synchronized motion to >> 'Position – Event – Generation' (PEG) – to control inspection tools or probes and record data. The advanced technology and highly modular system architecture of ACS ensures that the most demanding and complex applications are managed.

Modular Controller Architecture

ACS control distributed architecture is built of three tiers: The first tier is the host PC user interface which the motion system communicates with. The second tier consists of an EtherCAT®-based motion controller. The motion controller is responsible for communication with the host software and also manages profile generation real-time programs, diagnostics, and other high level functions. The third tier consists of Universal Drive Modules (and possibly other EtherCAT-based devices), which include a digital servo processor. It performs the real-time servo calculations. The drive modules power and actuate the motors, read the feedback devices, manage the I/Os, and provide closed-loop positioning control. A Control Module combines a motion controller and a Universal Drive Module to provide a single box controller & drives solution >> p. 27.



Interface: PEG – Position Event Generation

ACS controllers are capable to create pulses based on exact feedback positions. Position-Event-Generator (PEG) allows high speed position based outputs with under 100ns delay. These events can be used to trigger an external device, for example a laser, camera or inspection probe.

EtherCAT® Motion Controller



SPiiPlusEC Powerful Motion Controller and EtherCAT® Network Manager

up to 64 axes and thousands of I/O's



SPiiPlusES High Performance Multi-Axis Controller with Built-in EtherCAT®-to-EtherCAT® Bridge

up to 64 axes and thousands of I/O's

Combined Control and Drive Module



SPiiPlusCMhp/ba 32-Axis EtherCAT® Master Control Module with 3 Built-in Drives

1 to 3 drives, 85–265 V-AC, up to 15/30 A

Universal Drive Modules



NPMpm EtherCAT® Single/Dual Axis NanoPWM Drive Module

1, 2 drives, 12 – 100 V, up to 13.3/40 A



UDMsd EtherCAT® Dual/Quad Axis Drive Module

2, 4 drives, 12–48 V, up to 2.5/5 A



UDMpm EtherCAT® Single/Dual Axis Drive Module

1, 2 drives, 85–265 V, up to 7.5/15 A



UDMpa EtherCAT® Single/Dual Axis Drive Module

1, 2 drives, up to 100 V, 13.3/40 A

Integrated Motion Controller Solution

- 4, 6 or 8 motion axes
- Fully integrated closed-loop servo control, amplifier module, and power supplies
- Quiet PWM drives
- Encoder inputs support sine/cosine and BiSS-C
- For voice coil drives, DC motors and brushless 3-phase motors



Controlled by
ACS

The A-82x motion controller series offers a fully integrated electronics solution with controller, drives, and power supplies in a compact 4-U-high 19-inch rack unit. The A-82x motion controller features the state of the art ACS SPiiPlusEC motion controller and EtherCAT® master.



Find more ACS motion controller and drive solutions on the PI website www.pi.ws

NanoPWM™



Technology: NanoPWM™

Recent developments in PWM technology have produced NanoPWM™ amplifiers. These offer 'linear' amplifier performance but without the limitations commonly associated with such amplification. The drawbacks of linear amplifiers are: heat generation, physically larger units, robustness of the electrical device, cost and the ability to deliver high powers when compared to PWM units. NanoPWM™ amplifiers like linear amplifiers have improved velocity and tracking control, an ability to optimize the use of high resolution feedback, and in-position stability is superior.

Industrial Motion Control

High Performance – EtherCAT® Communication – Force Control

Digital Controller for Hexapods

- EtherCAT® fieldbus interface or control via TCP/IP and RS-232
- Position input via Cartesian coordinates, coordinate transformation handled by the controller
- To simplify integration of the hexapod, the reference system (Work, Tool) can be quickly and easily changed
- Supports incremental and absolute encoder types
- Separate control and bus voltage supply
- Extensive scan routines for automatic and active alignment
- LabVIEW support



C-887.53x



E-727.xF

Digital Controller for Piezo Nanopositioning Systems

- EtherCAT® fieldbus interface or control via TCP/IP and RS-232
- Behaves like an intelligent multi-axis drive system for up to 3 axes
- Supports strain gauge sensors, capacitive sensors or piezoresistive sensors
- Output voltage -30 to +130 V
- Extensive software support, LabVIEW, dynamic libraries for Windows and Linux

PIMag® Motion Controller with Force, Position, and Velocity Control

- 1 or 2 motor channels
- Up to 4 sensor channels for 2 force and 2 position sensors each
- Depending on version, TCP/IP or USB interface for configuration and commanding
- Depending on version, real-time SPI interface for sending commands
- Digital inputs and outputs, optional analog inputs and outputs
- Auto zero function for holding current



C-413



E-712

Digital Piezo Controller for up to 6 Axes

- Up to 50 kHz servo update rate
- Highly stable 20-bit D/A converter
- Real-time operating system for excellent trajectory control
- Autoloading of calibration data from stage ID chip for interchangeability of controller and mechanics
- Flexible interfaces: TCP/IP, USB, RS-232; optional broadband analog inputs and outputs
- Extensive software package



Manufacturing in Cleanrooms

Quality according to ISO 14644-1

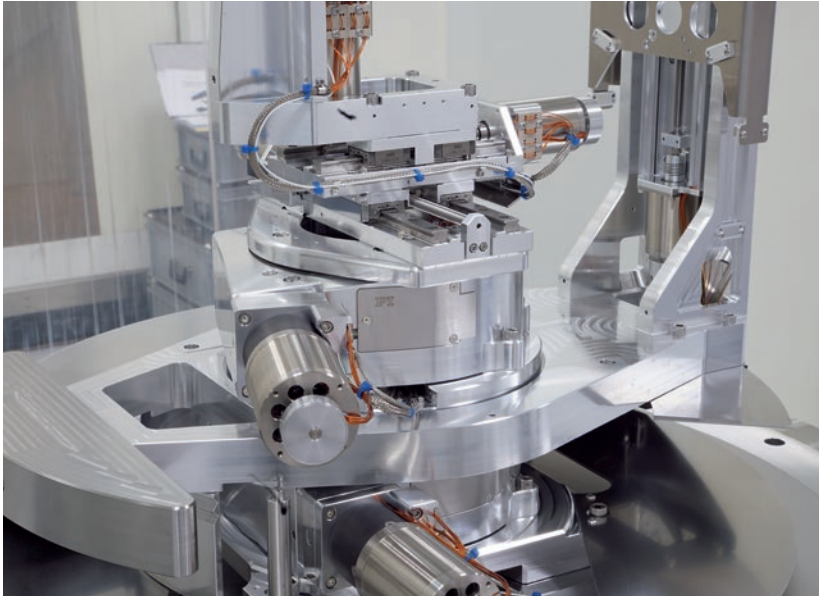

PI has the capability to manufacture and qualify products under cleanroom conditions at a number of production sites. This capability is extended and improved continually according to market needs. Depending on the processes at the respective locations, PI or its partners have the ability to clean parts and products at each location according to the regulations and then check the cleaning results for particle contamination and if necessary, for other types of contamination as well.

Calibrated particle measuring devices allow PI to monitor the cleanroom quality according the specifications of ISO 14644-1.

PI also has the ability to measure the quantity of particles that originate from its own products under operational conditions.

Class	Particle per m ³					
	0.1 µm	0.2 µm	0.3 µm	0.5 µm	1.0 µm	5.0 µm
ISO 5	100,000	23,700	10,200	3,520	832	
ISO 6	1,000,000	237,000	102,000	35,200	8,320	293
ISO 7				352,000	83,200	2,930
ISO 8				3,520,000	832,000	29,300

Available Cleanrooms

PI in Karlsruhe, Germany

PI Karlsruhe is the largest production und development site in the PI Group. Standard and custom products, mainly in the field of piezo-based positioning systems and hexapods, are assembled and qualified here. All areas for series production, including incoming goods inspection, are cleanrooms according to the ISO 8 classification. In addition, some of these cleanrooms contain ultraclean workplaces according to the ISO 5 classification. The Special Products Fractal has rooms classified according to ISO 7 and ISO 8 as well as ultraclean workplaces according to the ISO 5 classification. A production cleanroom according to the ISO 6 classification is currently being prepared. A laboratory according to the ISO 7 classification is available in the development department.

PI Ceramic, Lederhose, Germany

The entire process chain for multilayer production, beginning with tape casting, is realized at PI Ceramic in cleanrooms according to class 7; the assembly processes for piezo components and sensors also take place consistently in class 7 or class 8 cleanrooms. Depending on the process requirements, cleanrooms according to ISO classes 7 to ISO 9 are available for further selected processes such as sputtering, screen printing, and dispensing.

PI miCos, Eschbach, Germany

All assembly areas at PI miCos, including incoming goods inspection, are cleanrooms according to the ISO 8 classification. Some of these cleanrooms contain ultraclean workplaces according to the ISO 5 classification. The Engineered Systems area also has a cleanroom according to ISO class 7.

PI USA, Hopkinton

PI USA has an ISO class 8 assembly island in the production area, which includes measuring capabilities, cleaning, and packaging under cleanroom conditions.

Vacuum Know-How

Solutions for Positioning in Vacuum Conditions

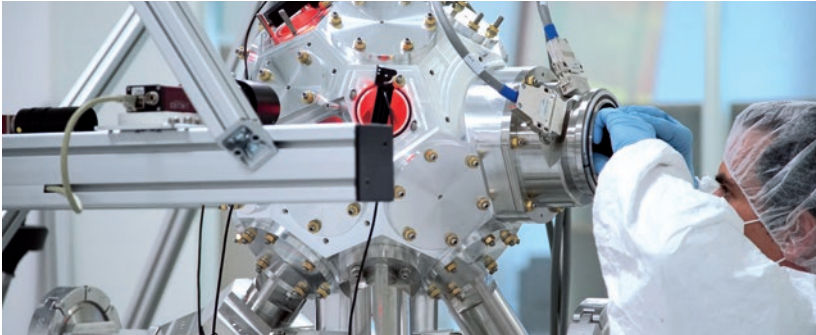

PI offers high-precision solutions for positioning in vacuum conditions to 10^{-10} hPa. Positioning solutions in a vacuum follow clearly defined constraints. This applies to the limited installation space, as well as prevention of contamination and excessive heat input.

Selection of the optimum drive technology for the respective application and the mechanical design must be matched exactly to the required load capacity and velocity as well as the intended operating and planned duty cycles.

The handling regulations for vacuum positioning systems are just as important as the design principles. Cleanrooms are available for assembling larger parts. Suitable packaging and the corresponding instructions for the recipient are part of shipping.

Vacuum chambers are available in several sizes with vacuum levels down to 10^{-10} hPa, where start-up and measurement of outgassing, but also interferometric measuring of position accuracy under real operating conditions is possible.



At PI, several vacuum chambers are available in various sizes

ESD Protection

Prevention of Malfunction or Breakdown of Electronic Devices

Automation equipment such as today's motion systems enable the many thousands of process steps required to manufacture a finished electronic device. These processes involve a lot of touch and placement operations that place, align, process, inspect and test the equipment around the site. Repeated handling and movement throughout the manufacturing process is an essential factor that increases the potential for damage to equipment from charging and subsequent electrostatic discharge (ESD).

ESD is the sudden flow of electric current that flows between two bodies at varying electrical potentials. Common causes of ESD events are static electricity and electrostatic induction where an electrically charged object is placed near a conductive object that is isolated from ground and then comes in contact with a conductive path.

When subjected to ESD, electrostatic sensitive objects, such as a wafers, chips, integrated circuits, sensors, electronics devices, and printed circuit boards, damage can be immediate and may cause a catastrophic failure. ESD can also lead to partially damaged devices which may still conform to specifications, however; once built into an electronic device, may cause reliability issues or premature failure.

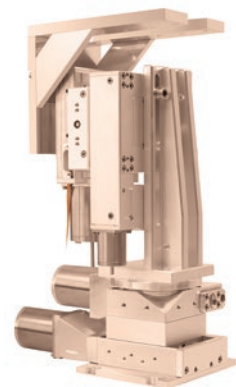

PI uses its knowledge to minimize such risks, for example by coating motion platforms with conductive electroless nickel, providing specially engineered cable management or drag chains and common ground procedures to maintain long-term conductivity.

From 1-off to Series:

OEM Customers Benefit From Maximum Flexibility

PI serves both the research and industrial markets. The complete control over the design and manufacturing process provides our customers with significant competitive advantages. Optimized processes allow PI to deliver customized products in quantities up to several 100,000 units per year at low cost and right on time. The range of OEM products offered by the PI Group varies widely, ranging from “bare” actuators and sensors to highly integrated parallel-kinematic positioning systems. Evaluation of pre-production run samples, test procedures, production processes and quality management are all included in the development process.

Services

- Global account management: Close proximity to the customer thanks to international presence
- Risk assessment from design to delivery
- Depending on the task: From the drive to the turnkey system
- Copy exactly policy
- Preparation of internal and external certification
- Production of series of several 10,000 units in the shortest time
- Sustainable spare parts service
- Manufacturing and testing capacities from functional samples to mass production

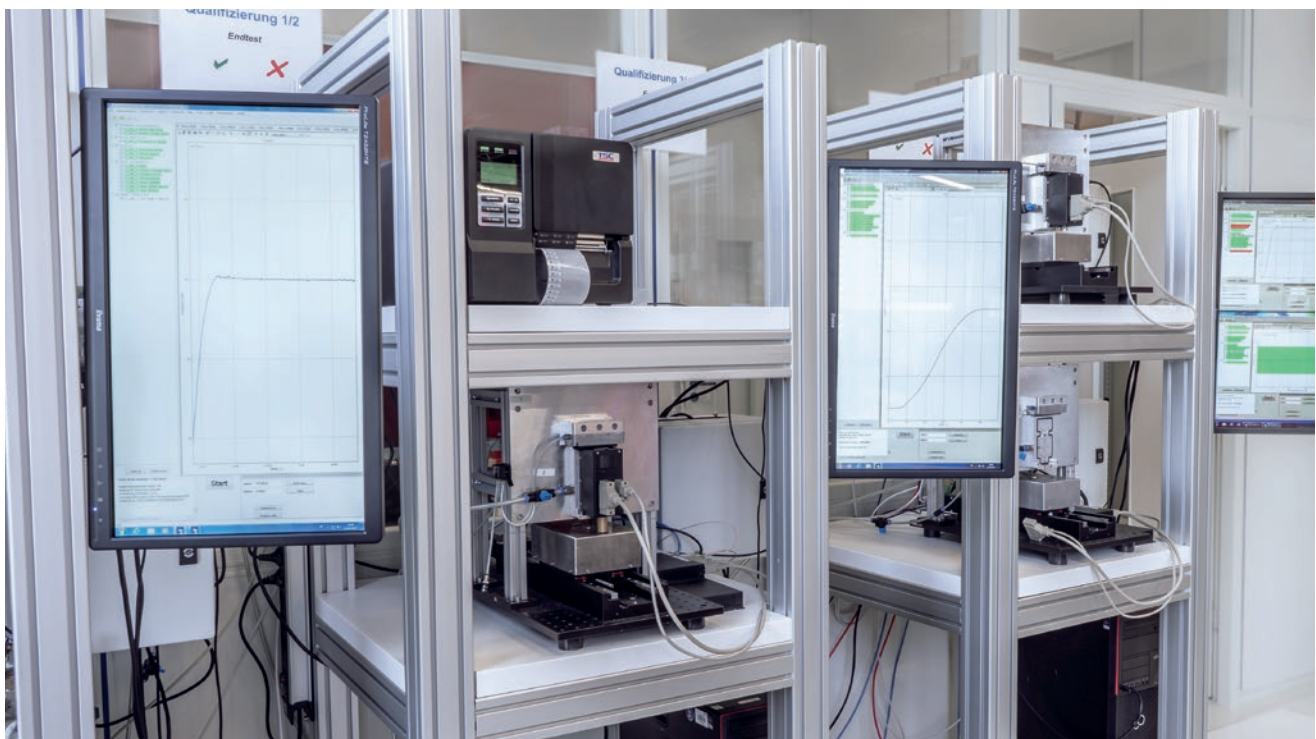

Standardized performance control with full documentation of individual measurement charts

Global Service and After-Sales

Tailored Service Packages for High-End Positioning Systems



On-site training is key to optimize and maximize the potential of new PI systems

Start-Up, User Training and Life Long Support

PI is dedicated to supporting its customers right from the initial consultation through to when a customer has purchased a PI system. Beyond that, PI's services division is committed to ensuring that every aspect of owning a PI system is catered for.

Global Coverage

Supported by 4 Global Service Hubs in Asia, China, Europe and USA, with field product specialists working from these hubs, PI is able to support all technologies and customer applications via this global services team.

PI's Standard On-Site Services

- Set up and Commissioning – On-site support to un-box, set-up and commission the PI system
- Training Program – User training on software and programming, through to optimization of system performance
- Maintenance Systems Health Check – Preventative maintenance to prolong the life of the motion device
- Support – Ongoing remote and on-site support to maximize system uptime and provide maintenance for the whole life of any system

Contracted Services

Customers subscribing to Contractual Support Services will receive commitment from PI to achieving agreed Service Levels. These include responding to the customer's first contact and providing remote technical support, through to response times for a PI expert to be on site, either to repair or replace a defective unit.

Extended Warranty

Most customer applications require PI's systems to be operational beyond the standard warranty period. Extending the warranty for additional year(s), is simply extending the customers peace of mind and PI's commitment that the product will not fail due to poor workmanship or faulty materials. Should a customer's system then fail due to these conditions, PI will cover the costs to repair or replace it.

The PI Group

A Strong Partner for Industry and Research



PI (Physik Instrumente) has been one of the leading players in the global market for precision positioning technology for many years. The technological diversity of the PI Group is unique all over the world. PI develops, manufactures, and qualifies all its core technologies itself. PI is therefore not dependent on components available on the market to offer its customers the most advanced solutions.

The complete control over vertically linked manufacturing processes allows flexible reaction to market developments and new requirements.

Modern organizational forms such as the fractal production model guarantee efficient production for batch sizes of 1, small series, and also OEM products in large quantities. By acquiring the majority shares in ACS Motion Control, a worldwide leading developer and manufacturer of modular motion controllers for multi-axis drive systems, PI can also offer solutions from one single source to meet the industry's increasing demands on precision and throughput.

The foremost priority for PI is to be a reliable and highly qualified partner for the customer.

Core Technologies

- In-house manufacturing of piezo components and piezo actuators
- Magnetic direct drives: linear motors and voice coils
- Air bearings, magnetic and flexure guides
- Comprehensive range of piezo motor technologies
- Nanometrology sensors
- Parallel-kinematic systems for positioning in six axes (Hexapods)
- Motion control technology
- Software

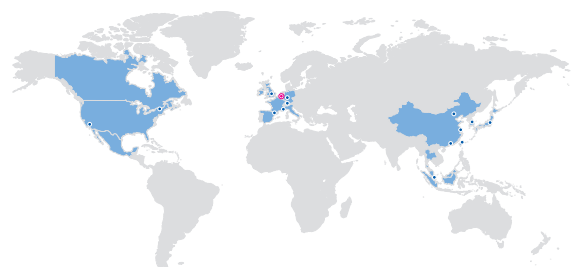

The PI Group Milestones

A Success Story

PI has been developing and manufacturing standard and OEM products with piezo or motor drives for more than 40 years. Continuous development of innovative drive concepts, products, and system solutions and more than 200 technology patents distin-

guish the company history today. In addition to four locations in Germany, the PI Group is represented internationally by fifteen sales and service subsidiaries. PI is a privately owned company with healthy growth and more than 1000 employees worldwide.



Market introduction of the PICMA® multilayer piezo actuators



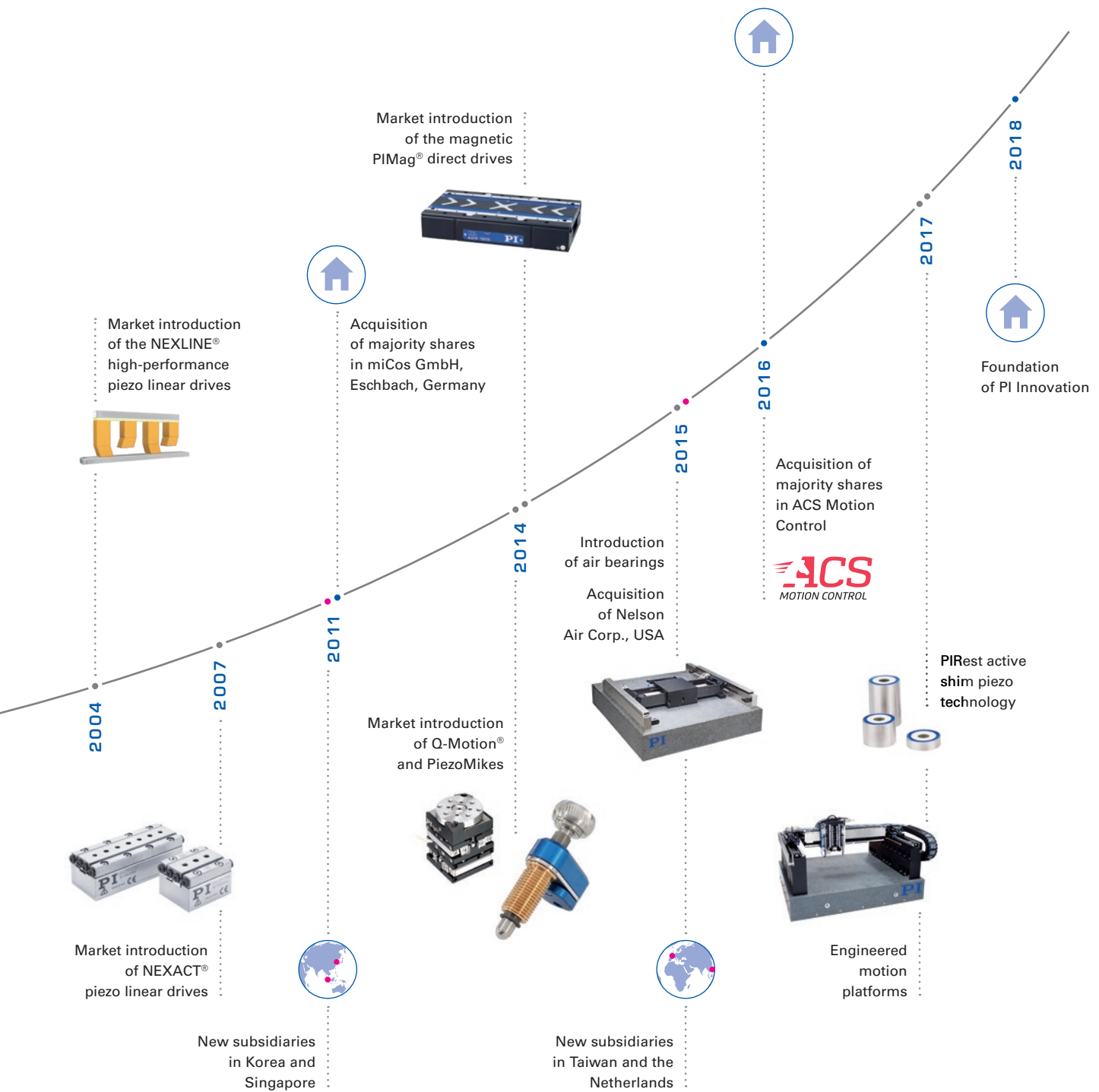



Headquarters

GERMANY

**Physik Instrumente (PI)
GmbH & Co. KG**
Auf der Roemerstrasse 1
76228 Karlsruhe
Phone +49 721 4846-0
Fax +49 721 4846-1019
info@pi.ws
www.pi.ws

PI miCos GmbH

Freiburger Strasse 30
79427 Eschbach
Phone +49 7634 5057-0
Fax +49 7634 5057-99
info@pimicos.com
www.pi.ws

PI Ceramic GmbH

Lindenstrasse
07589 Lederhose
Phone +49 36604 882-0
Fax +49 36604 882-4109
info@piceramic.com
www.piceramic.com

© Physik Instrumente (PI) GmbH & Co. KG

All contents, including texts, graphics, data etc., as well as their layout, are subject to copyright and other protective laws. Any copying, modification or redistribution in whole or in parts is subject to a written permission of PI.

Although the information in this document has been compiled with the greatest care, errors cannot be ruled out completely. Therefore, we cannot guarantee for the information being complete, correct and up to date. Illustrations may differ from the original and are not binding. PI reserves the right to supplement or change the information provided without prior notice.

Follow us on:



ACS Motion Control

ISRAEL

ACS Motion Control Ltd.
Ramat Gabriel Industrial Park
1 Hataasia St.
Migdal HaEmek, 2307037
POB 984
Phone +972-4-6546440
Fax +972-4-6546443
info@acsmotioncontrol.com
www.acsmotioncontrol.com



PI Subsidiaries

USA (East) & CANADA

PI (Physik Instrumente) L.P.
Auburn, MA 01501
www.pi-usa.us

USA (San Francisco Bay Area)

PI (Physik Instrumente) L.P.
Sausalito, CA 94965
www.pi-usa.us

ITALY

Physik Instrumente (PI) S. r. l.
Bresso
www.pionline.it

FRANCE

PI France SAS
Aix-en-Provence
www.pi.ws

JAPAN

PI Japan Co., Ltd.
Tokyo
www.pi-japan.jp

CHINA

**Physik Instrumente
(PI Shanghai) Co., Ltd.**
Shanghai
www.pi-china.cn

SOUTHEAST ASIA

**PI (Physik Instrumente)
Singapore LLP**
Singapore
www.pi-singapore.sg
For ID / MY / PH / SG / TH / VNM

KOREA

PI Korea Ltd.
Seoul
www.pikorea.co.kr

USA (West) & MEXICO

PI (Physik Instrumente) L.P.
Irvine, CA 92620
www.pi-usa.us

UK & IRELAND

PI (Physik Instrumente) Ltd.
Cranfield, Bedford
www.physikinstrumente.co.uk

NETHERLANDS

PI Benelux B.V.
Sint-Oedenrode
www.pi.ws/benelux

SPAIN

Micos Iberia S.L.
Vilanova i la Geltrú
www.pimicos.es

PI Japan Co., Ltd.

Osaka
www.pi-japan.jp

**Physik Instrumente
(PI Shanghai) Co., Ltd.**

Beijing
www.pi-china.cn

TAIWAN

**Physik Instrumente (PI)
Taiwan Ltd.**
Taipei
www.pi-taiwan.com.tw