

Automation Platforms for Laser Material Processing

PRECISION - THROUGHPUT - SYNCHRONIZED MOTION

Advanced Automation Platforms for Laser Material Processing

Cutting, marking, micromachining, drilling or metal deposition – lasers are used in a wide variety of processes in many different industrial sectors to optimize manufacturing processes and to ensure the high quality of workpieces. This for example, is how the electronics manufacturing, semiconductor industry, automotive industry, or medical device technology benefits from the advanced capabilities of laser material processing. Today the laser performance is normally not a limiting factor for the productivity.

Process, material, work cycle, ambient conditions, and criteria such as throughput, precision, geometry tolerances, size of the machining surface, and contours, all make different demands on the automation platforms. For example, as far as throughput and precision is concerned, it is possible to meet the different requirements when system components such as the mechanics, laser control, and laser beam steering complement each other and communicate via a high-performance standard industrial networks.

The technological diversity and the high vertical range of manufacturing enables PI to react flexibly to the market development in laser technology and to offer automation platforms for high-precision and high-throughput laser processing that address the needs of OEMs, integrators and end users: From single and multi-axis systems without beam deflection to highly customized solutions where the motion of galvanometer scanners and the positioning systems have to be synchronized and are able to run simultaneously.

ACS Motion Control, as part of the PI Group, allows the supply of highly sophisticated automation and motion controllers with a wide range of drive options and dedicated modules for the control of laser applications. The controllers and components are based on an industry standard EtherCAT® network. ACS Motion Control and PI motion systems are matched to each other to offer class leading platforms for the laser engineer.

A solution from PI does not just offer the machine builder advanced positioning technology and high-performance control solutions, but also faster startup and high flexibility when implementing new requirements to laser processing systems.

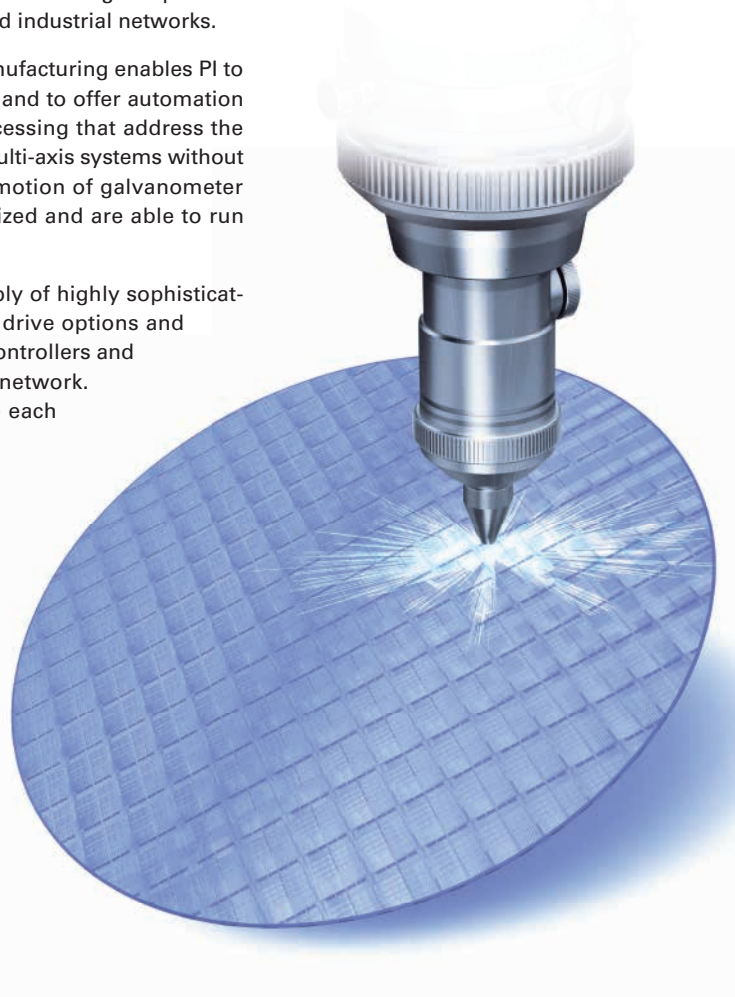

Industrial Laser Micromachining

Small Geometries – High Dynamic – Debris Protection

Machining workpieces for generating tiny geometries in the micron range demands automation platforms that provide a consistent, accurate and dynamic processing in multiple dimensions. As the size and mass of the manufactured parts may be challenging and particles may be formed during machining, the system components used need to be highly precise, stiff, robust and offer reliable performance.

Key Features of the Stages

- Reference edge to support the alignment in the machine
- Connector for purge air to create overpressure
- Side seal and hard cover to protect against particles
- Robust industrial IP65 connectors for flexible cable exit
- Easy access to the lubrication system
- Different encoder variants including absolute-measuring sensors offering nanometer resolution
- Different stage widths for different loads and cantilever reduction

Vertical Axis – Laser Positioning

- Synchronous servo motor
- Heavy-duty recirculating ball bearings
- Holding brake
- Ability to run directly on 110/240 volts AC servo drives
>> L-417, p. 6

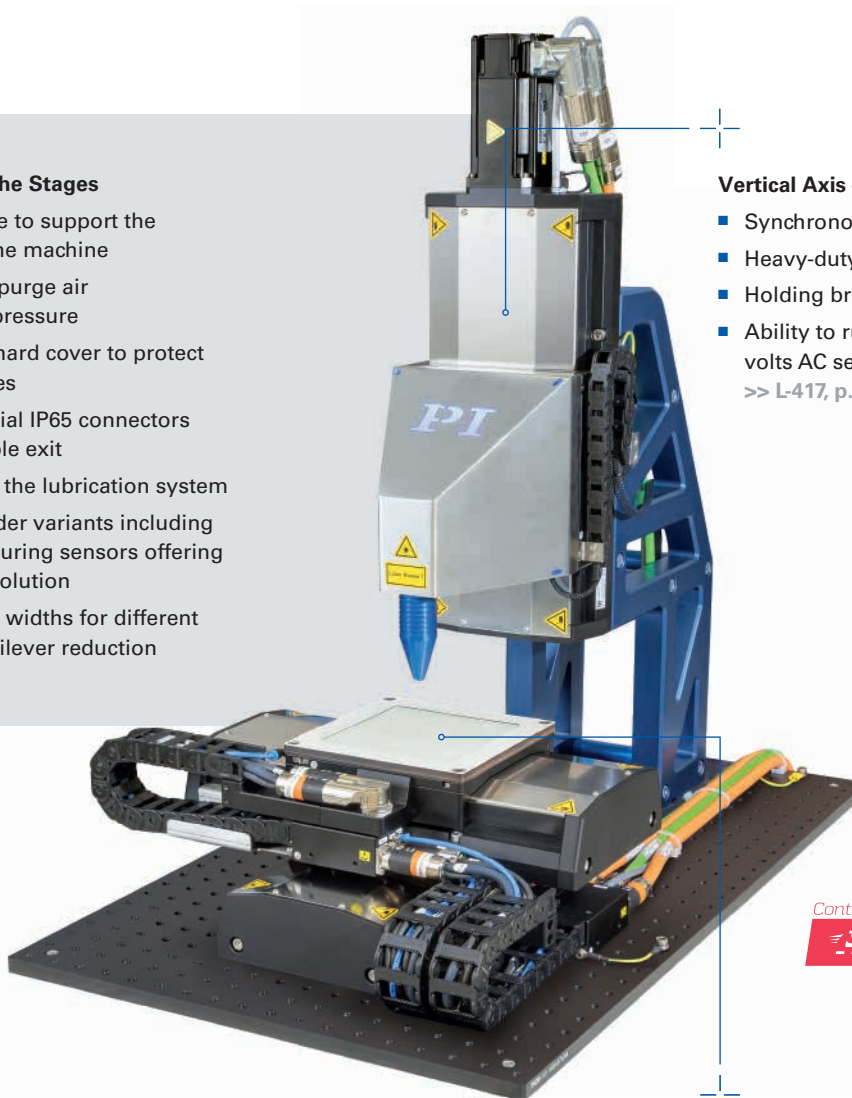

Controlled by

Motion Control

The multi-axis system can be controlled by an ACS motion control module for optimum synchronization of the axes and simultaneous control of the laser
>> LCM, p. 19

XY Axis – Workpiece Positioning

- PIMag® linear motors
- Heavy-duty recirculating ball bearings
- XY configuration without adapter plate
- XY drag chain cable management
>> V-417, p. 6



Have a look at the systems in motion on the PI YouTube channel www.youtube.com/user/phyinst

Laser Cutting

High Precision – High Dynamic – Long Travel Ranges

Laser applications such as those for producing stencils or processing printed circuit boards and flat panels set high requirements to automation platforms: The dimensions and mass of the workpieces, and the structural density are typically large in comparison. To achieve micron precision and high throughput, the system has to offer long travel ranges with a high stiffness but light weight motion platform. This allows the laser head or galvanometer scanner to be moved at high speed precisely over the part.

Key Features of the Gantry Design

- High mechanical stability
- Light weight motion platform/bridge axis
- Disturbance rejection
- Individual travel ranges in XY up to 2 m
- Risers/lifter to place the vertical axis at required processing height
- Motion profiles may be raster based or a complex contour

Vertical Axis – Laser Positioning

- PIMag® linear motors with pneumatic counterbalance >> p. 13
- Optimized cable management and operation to place vertical motion axes, autofocus sensors, and fiber routing system for the laser
- The integration of autofocus sensors allows height tracking to maintain spot focus

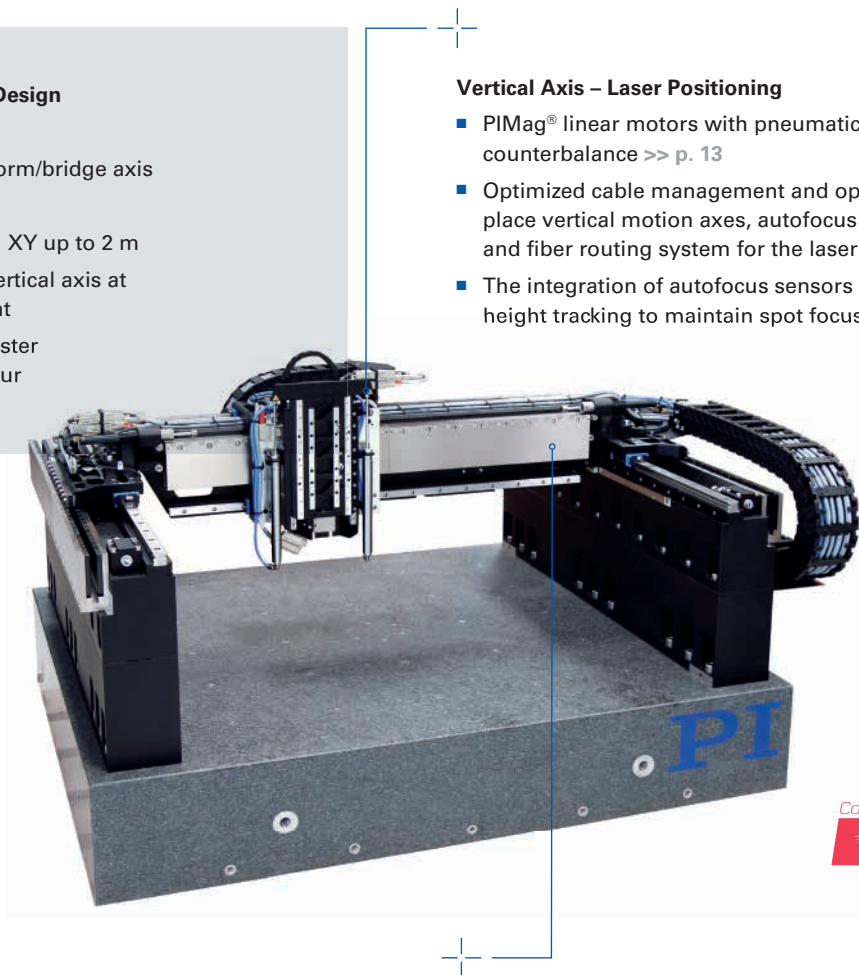

Motion Control

The gantry system can be controlled by an ACS motion control module which:

- Provides multi-input multi-output optimization for yaw and linear control (MIMO)
- Automatic cross-axis tuning for consistent performance over all gantry areas
- Input shaping for vibration free motion and vastly improving move and settle times

XY Axis – Workpiece and Tool Positioning

- Base axis: dual PIMag® linear motors for high dynamics and high precision >> p. 13
- Bridge axis optionally with air bearings for demanding straightness and velocity requirements >> p. 9
- Absolute encoders provide the absolute position of the moving system. Homing is not required during power-on, which increases efficiency and safety during operation. For example axes binding or collisions with parts can be eliminated

Extra Large Field Marking

High Precision – High Throughput – Simultaneous 2D Processing

Processing high density structures over large areas such as hole drilling, or glass and foil marking requires automation solutions which provide high precision and high velocities. A possibility to address the needs of industrial production is the coordination of multi-axis positioning systems with a high dynamic galvanometer scanner. Typically the stages move the workpiece to the center of the field of view of the scan head and signal that the scanning process can be started. Once this operation is completed, the process is repeated until the total area is processed.

In order to process an area that exceeds the field view of the galvanometer scanner more efficiently, simultaneous control of the XY stages and the galvanometer scanner is favorable. This XLSCAN solution allows continuous operation over large areas avoiding idle time and eliminating stitching errors. The ability of extending the field of view by the travel ranges of the stages has the advantage that the field of view can be fixed and maintained in terms of accuracy, spot size and performance.

Key Features of the XLSCAN Automation Solution

- Extra large field of view
- Increased throughput (up to 41 %)
- Increased processing accuracy
- Elimination of the potential discontinuities caused by tiling or stitching multiple fields of view of the scan head
- Smooth processing with high dynamics and no stage vibrations

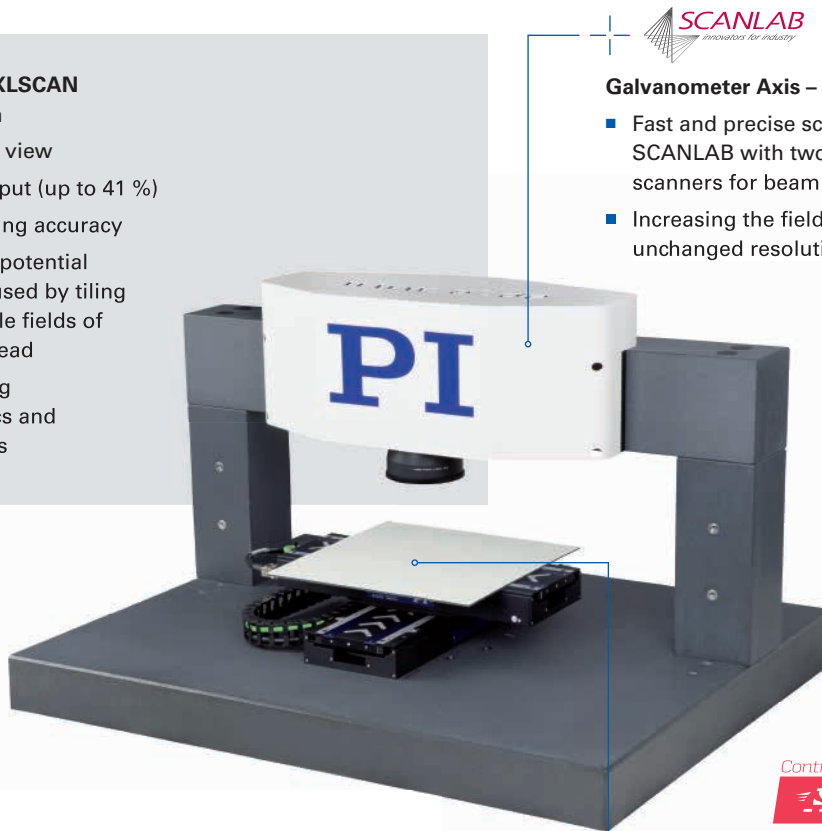

Galvanometer Axis – Fast Laser Positioning

- Fast and precise scan system from SCANLAB with two galvanometer scanners for beam control
- Increasing the field of view with unchanged resolution and spot size

Motion Control

Class leading digital scanner technology with EtherCAT® based industrial networking

A patent pending coordination of SCANLAB's scan head control with the linear stages managed by an ACS motion control system

XY Axis – Workpiece Positioning

- PIMag® linear motors for high precision and high velocity >> V-551, p. 7
- Linear guides with crossed roller bearings
- XY drag chain cable management
- Granite base for optimized system accuracy



Have a look at the systems in motion on the PI YouTube channel www.youtube.com/user/phyinst

Precision Linear Stages

High Load – Long Travel Ranges – Cost Efficient



Applications: Cutting · Drilling · Welding
Positioning tasks: Single-axis, XY and Z configurations · Highly repeatable accuracy · Consistent performance

- Width 116 mm, 166 mm
- Travel range to 610 mm, to 813 mm
- Synchronous servo motor
- Precision recirculating ball bearings, load capacity to 400 N, to 450 N
- Side seal and air purge
- Optional holding brake



L-412 · L-417



Applications: Cutting · Drilling · Welding · Contouring tasks
Positioning tasks: Single-axis and XY configurations · High accuracy



V-412 · V-417

- Width 116 mm, 166 mm
- Travel ranges to 610 mm, to 810 mm
- High nominal force 33 N, 87 N
- PIMag® linear motor >> p. 13
- Precision recirculating ball bearings, load capacity to 400 N, to 450 N
- Side seal and air purge
- Drag chain cable management



XY configuration
of the V-417

High-Precision Linear Motor Stages

High Accuracy – High Dynamic – Flexible Configuration



Applications: Ultrafast micromachining and nanofabrication
Positioning tasks: Fast and precise scanning · Compact design

- PIMag® voice coil with direct positioning measuring
- Travel ranges 5 mm, 10 mm, 20 mm
- Max. velocity 250 mm/s
- Crossed roller bearings for the highest precision, anti-creep



V-522 · V-524 · V-528



Applications: Ultrafast micromachining and nanofabrication
Positioning tasks: Single axis, XY and Z configurations · Fast scanning with nanometer precision



V-508

- PIMag® linear motor >> p. 13
- Travel ranges 80, 170, and 250 mm
- Incremental or absolute linear encoder, various resolutions
- Compact cross section: 80 mm x 25 mm
- Crossed roller bearings for high load capacity, anti-creep

- PIMag® linear motor >> p. 13
- Travel ranges to 230 mm
- Absolute encoder with 1 nm resolution
- Highest precision with >> **PIOne linear encoder**
- High guiding accuracy
- Compact design with 160 mm width
- Crossed roller guide, anti-creep



V-551



Technology: PIOne Linear Encoder

The high-resolution PIOne encoder was developed by PI and, with corresponding processing of the measured values, allows a position resolution considerable less than one nanometer. The optical and noncontact PIOne encoders are based on an interferometric measuring principle. Due to the short signal period and the high quality of the signals, the linearity error of PIOne encoders is less than 1 %. PIOne encoders support direction sensing when evaluating a reference signal. A V-551.4D with PIOne linear encoder performs a sequence of 0.5-nm steps.

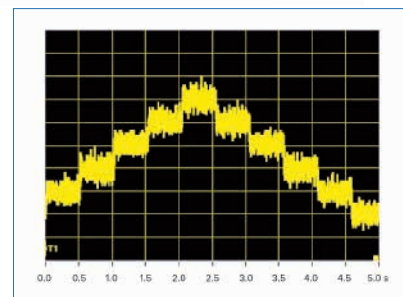

High-Precision Ball Screw Linear Stages

High Travel Accuracy – Compact Design – Cost Efficient



Applications: General purpose · Processing of heavy loads

Positioning tasks: High precision at medium travel ranges and low speed · Z axis configurations

- Travel ranges 102, 204, and 306 mm (4", 8", 12")
- Max. velocity to 100 mm/s
- Encoder resolution 50 nm
- Load capacity to 100 kg
- Zero-play ball screw
- XY and XYZ configurations



M-511 · M-521 · M-531



Applications: General purpose · Processing of light substrates

Positioning tasks: High precision at medium travel ranges and low speed



L-509

- Travel ranges from 26 to 102 mm (1" to 4")
- Repeatability to 0.1 µm
- Optional with Direct-Measuring Linear Encoder
- ActiveDrive DC, DC, BLDC, and DC gear motors
- Stepper motors
- Direction-sensing reference point switch

- Travel ranges to 155 mm (6")
- Repeatability to 0.1 µm
- ActiveDrive DC, DC, BLDC, and DC gear motors
- Stepper motors
- Optional linear encoder for direct position measurement
- Direction-sensing reference point switch



L-511

Ultra-High Precision Linear Air Bearing Stages

High Guiding Accuracy – Exceptional Velocity Control – Long Travel Ranges



Applications: Scribing · Drilling · 24/7 operation

Positioning Tasks: Highest flatness, straightness, velocity and precision · Split bridge arrangements

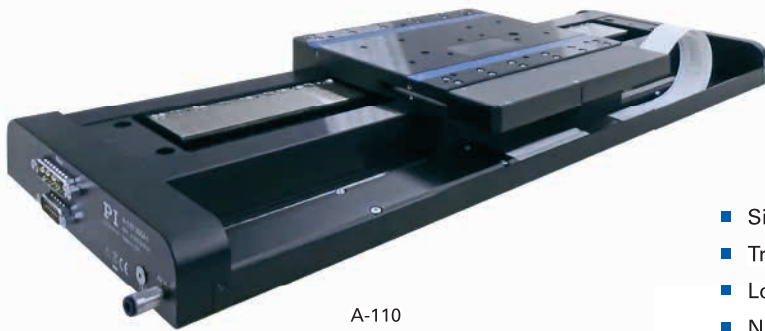

A-110

- Size of the motion platform 160 mm × 200 mm
- Travel ranges to 400 mm
- Load capacity to 100 N
- Noncontact and friction-free motion
- Magnetically preloaded >> air bearings
- Cleanroom compatible

- Size of the motion platform 210 mm × 210 mm
- Travel ranges 50 mm to 750 mm
- Resolution to 1 nm
- Noncontact and friction-free motion
- Preloaded >> air bearings
- Cleanroom compatible



A-123



Technology: Pliglide Air Bearing

The Pliglide air bearing technology allows friction-free positioning with exceptional on axis error motion accuracy of up to 5 μ rad over 100 mm. The technology provides high in position stability and constant velocity scanning. Air bearings have straightness and flatness characteristics that are superior to mechanical bearing solutions.

High-Precision Compact Linear Stages

Very Compact Design – Cost Efficient – Flexible Configurations



Applications: Positioning of workpieces or optics

Positioning Tasks: High repeatable accuracy · Short travel ranges · Compact design



M-110 · M-111 · M-112

- Travel ranges 5 mm, 15 mm and 25 mm
- Min. incremental motion 50 nm
- Max. velocity 2 mm/s
- Closed-loop DC servo and stepper motor versions
- Noncontact limit and reference point switches
- Vacuum-compatible version down to 10^{-6} hPa

- Travel range 25 mm
- Integrated linear encoder option for highest accuracy with 0.1 μm resolution
- Min. incremental motion 0.2 μm
- Max. velocity 20 mm/s
- Ball screw for high velocities and number of cycles



M-122

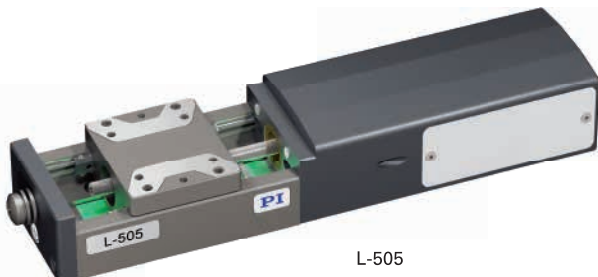

L-505

- Travel ranges 13 or 26 mm
- Stepper motor or DC servo motor with and without gearhead
- Velocity to 15 mm/s
- Load capacity to 30 N
- Integrated reference point and limit switch

Precision Z Stages

High Loads – High Stability – Highly Practical



Applications: Vertical part motion · Fine focus adjustments
Positioning Tasks: Unobstructed access to the table top from any direction

- Travel range 26 mm (1")
- High-resolution encoder
- ActiveDrive DC, DC, BLDC, and stepper motors
- Zero-play ball screw
- MTBF 10000 h
- Self-locking to 10 kg



- Travel range 13 mm (1/2")
- Unidirectional repeatability to 0.05 µm
- Load capacity to 20 kg
- Integrated optical limit switches
- Available with direct-measuring encoder
- Crossed roller guide, anti-creep

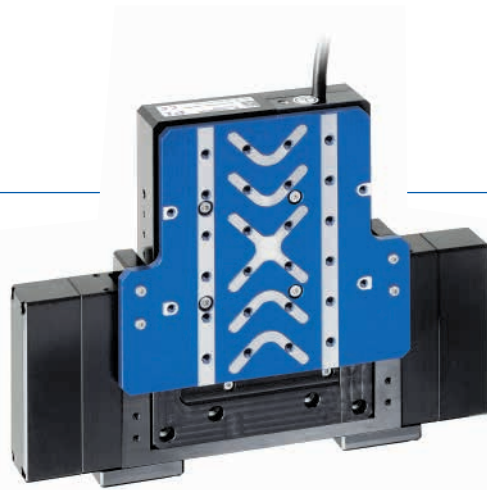

From Standard to Custom Products:

The dynamics and precision of voice coil or linear motor stages may be required in vertical direction. For an improved position stability and compensation of gravity PI offers various solutions for a counter balance system which can be based on springs, magnetic solutions and pneumatic cylinders. The picture shows a modified V-528 standard product with PIMag® direct drive and gravity compensation for vertical applications. The compensation is by a constant force spring and is adjusted precisely to the customers payload.

High-Precision XY Linear Motor Stages

High Geometric Precision – High Velocity – High Stability



Applications: Cutting · Drilling · Contouring with high geometric accuracy · Micromachining where maintaining focus is important
Positioning tasks: High precision contouring or raster scanning · Nanometer resolution · Aperture versions for processing from top and bottom

- Travel range 205 mm x 205 mm (8"), 350 mm x 305 mm
- Unidirectional repeatability to 0.1 µm
- PIMag® linear motor >> p. 13
- Velocity to 200 mm/s
- Incremental linear encoder with 1 nm resolution
- Crossed roller guides, anti-creep



V-731 · V-741*

- Travel range 102 mm x 102 mm (4")
- Large aperture, 150 mm x 150 mm
- Unidirectional repeatability to 0.1 µm
- Velocity to 500 mm/s
- PIMag® linear motor >> p. 13
- Incremental linear encoder with 1 nm resolution



V-738*

* Also available with stepper motor or DC motor



From Standard to Custom Products:

All essential technologies required for the drive or motor, the measuring system, the motion controller, and the guiding system, are available in-house at PI. To serve custom requirement, in-house development and the production capabilities of PIMag® magnetic drive technologies can be utilized.

Here is an example of a modified XY stage with PIMag® linear motors. The customer required shorter processing times, higher precision at high duty cycles, and improved accuracy while adding a higher mass workpiece. In order to achieve these requirements, a new stage was developed based on the experience with PI standard stages like the V-741. The new stage is designed with increased power ironless linear motors to offer higher accelerations and lower heating.

The newly designed body of the stage is more rigid providing higher stiffness, improved straightness and flatness with the use of higher loads. In addition the use of an absolute encoder enables the customer, to simplify startup and improve throughput of the machine.



- Travel range 305 mm x 305 mm (12"x12")
- Max. velocity 1000 mm/sec
- Load capacity up to 5 kg
- Absolute optical encoder
- Encoder with BiSS C communication
- ACS Motion Controller

High-Precision XY Air Bearing Stages

High Precision Scanning – Ultimate Geometric Precision – High Accuracy



Applications: Laser micromachining and laser ablation where ultimate precision with long term repeatable processing is required

Positioning Tasks: Exceptional flatness for low deviation in spot size. Straightness and orthogonality for correct feature shapes and two-dimensional placement

- Travel ranges to 200 mm x 200 mm
- Load capacity to 147 N
- Low profile
- Resolution to 1 nm
- Air Bearings >> p. 9
- Optional granite base plates
- Cleanroom compatible

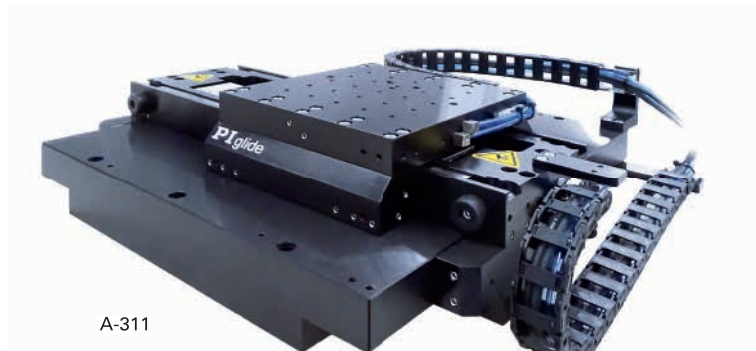

A-311



Applications: Flat panel processing · Laser scribing · Wafer dicing · Thin film patterning

Positioning Tasks: Highest level of flatness, straightness and orthogonality

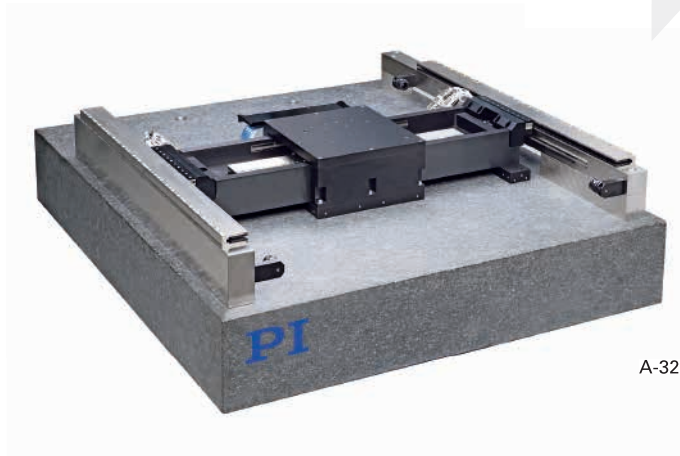

A-322

- Travel ranges to 500 mm x 1000 mm
- Load capacity to 245 N
- Resolution to 1 nm
- Air Bearings >> p. 9
- Velocity up to 2 m/s
- Cleanroom compatible



Technology: PIMag® Linear Motors

Magnetic direct drives from PI provide a direct and stiff connection between the load to be moved and the drive. The industry demand is particularly high when objects need to be positioned with high dynamics and precision. In conjunction with the smooth-running precision air bearings, these types of linear systems are particularly suitable for applications that require constant-velocity scanning. The drives operate without mechanical contact and therefore are very reliable. PIMag® linear motors are the result of in-house development. In this way, specific properties of the stages can be influenced directly.

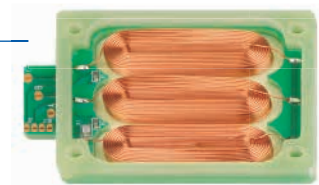

Precision Rotation Stages

High Rotational Accuracy – Direct Position Measurement – Aperture

- Unlimited travel range
- Ultra-high resolution
- Maximum velocity 200°/s
- Optional angle measuring system for direct position measurement
- ActiveDrive DC, DC, BLDC, and stepper motors
- Direction-sensing reference point switch

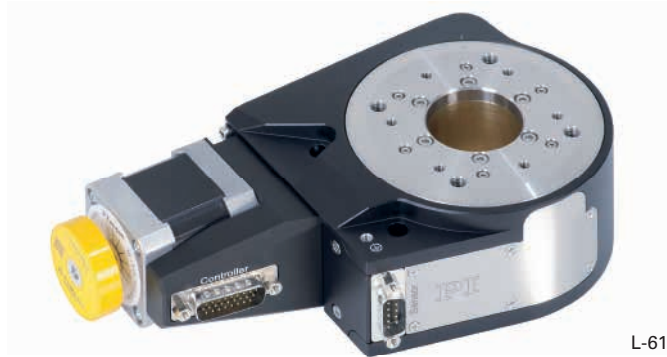

L-611



Applications: Laser machining of curved surfaces, for example tubing

Positioning tasks: Low speed rotation · Direct measuring capability to increase table top position accuracy · Aperture for component placement and beam delivery



PRS-200

- Unlimited travel range
- Repeatability to 0.5 μ rad
- Load capacity to 50 kg
- Option: Direct position measurement with angle measuring system



From Standard to Custom Products:

PI's proprietary technological know-how and vertically integrated production are the basis for the successful development of customized motion. All technologies can be adapted specifically to an application. An example of a customized solution is a direct drive rotation stage for part handling with an integrated collet. An other example could be the integration of a tube holding assembly.



Ultra-Precision Rotation Stages

Exceptional Velocity Control – High Placement Accuracy – Aperture



Applications: Laser processing of curved surfaces, for example tubing

Positioning Tasks: High accuracy of position even during multi-axis contouring · Low profile and weight to reduce errors associated with working height · Elimination of cogging for smooth velocity control · Direct-measurement at table top position · Aperture for component placement or beam delivery

- Unlimited travel range
- Velocity to 360 °/s
- Repeatability to 1.4 μrad
- Clear aperture with 20 mm diameter



UPR-100



UPR-120

- Unlimited travel range
- Velocity to 360 °/s
- Incremental angle measuring system with 0.017 μrad resolution
- Clear aperture with 35 mm diameter



Applications: Laser Processing of curved surfaces

Positioning Tasks: Zero wear to ensure highest continuous performance · Highest accuracy of position and control of geometric errors such as flatness and eccentricity · High stiffness and load capacity · Low asynchronous errors · Aperture for component placement or beam delivery

- 200 mm or 300 mm motion platform diameter
- Low profile, 60 mm
- Eccentricity and flatness < 100 nm
- Option for self-locking at rest by magnetic preload
- Air Bearings >> p. 9



A-63x

Parallel Kinematic Hexapods

High Stiffness – Freely Definable Pivot Point – Compact Design

Welding and cutting of complex geometries such as seam welding of pacemakers requires high-precision multi-axis motion. Parallel kinematic hexapods can be used for this task. They can also be combined with a rotation stage to achieve 360° rotational motion with unlimited travel range. If it is physically difficult to position the workpiece, it is also possible to move the laser source with a hexapod and use the workpiece/tool reference system ability.

Key Features of Hexapods

- Three linear axes, three rotational axes
- High stiffness
- Low moving mass, low inertia
- Excellent dynamic behavior, fast step-and-settle
- Minimized axis crosstalk motion
- Excellent repeatability
- Small installation space
- Large central aperture
- No moving cables

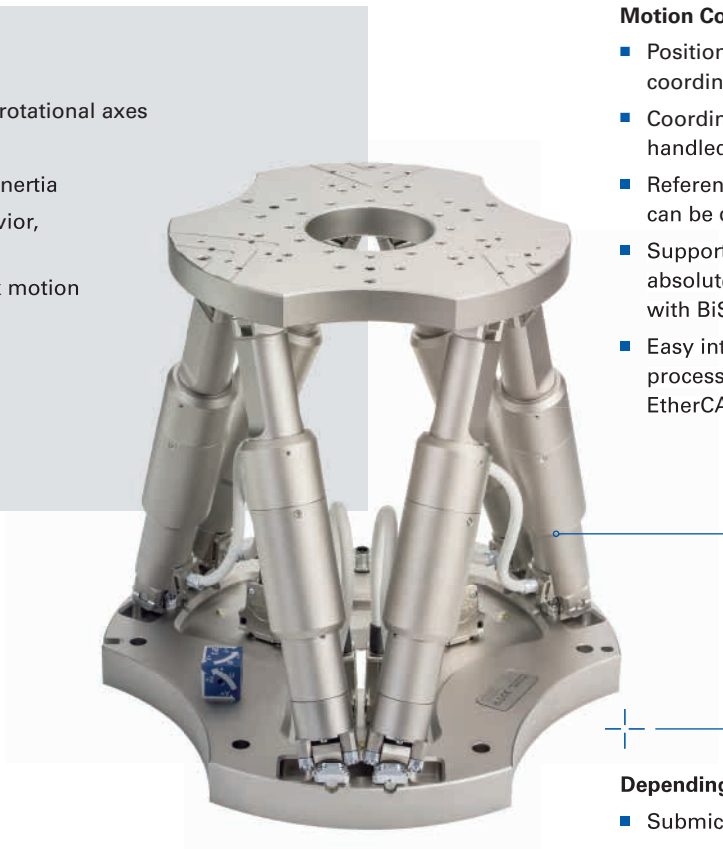

Motion Control

- Position input via Cartesian coordinates
- Coordinate transformation handled by the controller
- Reference system (work, tool) can be quickly and easily changed
- Support of motor brakes and absolute-measuring sensors with BiSS interface
- Easy integration in automation processes via industrial EtherCAT® interface

Depending on the Design:

- Submicron precision
- Dynamic to 30 Hz
- Load capacity to several tonnes

▶ Have a look at the systems in motion on the PI YouTube channel www.youtube.com/user/phyinst



Technology: Parallel Kinematic Hexapods

In a parallel-kinematic hexapod all drives act on a single moving platform, which results in a much more compact design than possible with stacked systems. Compared to a serial robot, hexapods show a much better ratio of payload to operating weight. As only one platform is moved, the overall moved mass is lower resulting in higher dynamics in all motion axes. Serial motion and positioning platforms have their advantages in the high modularity which allows for individual design of each moving axes. Motion control, especially the homing procedure, is simpler with no coordinate transformation required. On the other hand, the combined positioning errors of stacked systems affect the attainable overall system accuracy. Hexapods can have an improved path accuracy, higher repeatability and flatness of travel.

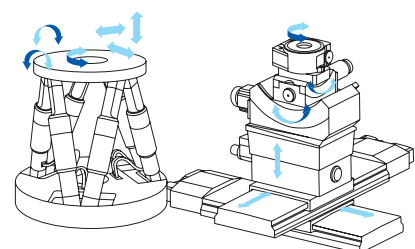

Tip/Tilt Platform and Objective Scanner

High Dynamic – High Guiding Accuracy – Outstanding Lifetime



Applications: Laser scanning and beam steering with high duty cycles and high-frequency motion
Positioning Tasks: Wear-free and small footprint design · High stability and repeatability at frequencies up to 2.5 kHz · Single mirror design for consistent multi-dimensional deflection

- Tip/tilt angle up to 5 mrad, optical deflection angle up to 10 mrad (0.57°)
- Parallel-kinematic design for identically high performance characteristics for both tip/tilt axes
- High resonant frequencies for dynamic motion and fast step-and-settle
- Position sensors for high linearity
- For mirrors up to Ø 12.7 mm (0.5")
- Outstanding lifetime due to >> PICMA® piezo actuators



S-331



Applications: Two-photon polymerization
Positioning Tasks: Zero-play · High-precision flexure guide system resulting in superior step-and-settle and scanning operation · Fine positioning of objectives with sub-nm resolution



P-725

- Travel ranges to 460 µm
- Significantly faster response and higher lifetime than motorized drives
- Fine positioning of objectives with sub-nm resolution
- Direct metrology with capacitive sensors: Highest linearity
- Zero-play, high-precision flexure guide system for better focus stability
- Outstanding lifetime due to >> PICMA® piezo actuators



Technology: PICMA® Multilayer Piezo Actuators

PICMA® actuators take advantage of the indirect piezoelectric effect and achieve high forces with relatively low voltages. They only need a small amount of installation space. At the same time, the PICMA® actuators are very dynamic and can reach a position with an unprecedented precision. Due to their ceramic insulation, PICMA® actuators exhibit high reliability and climate resistance. PI also equips PICMA® actuators with individual connections for customer applications.



Industrial Motion Control

High Performance – EtherCAT® Communication – Highly Modular

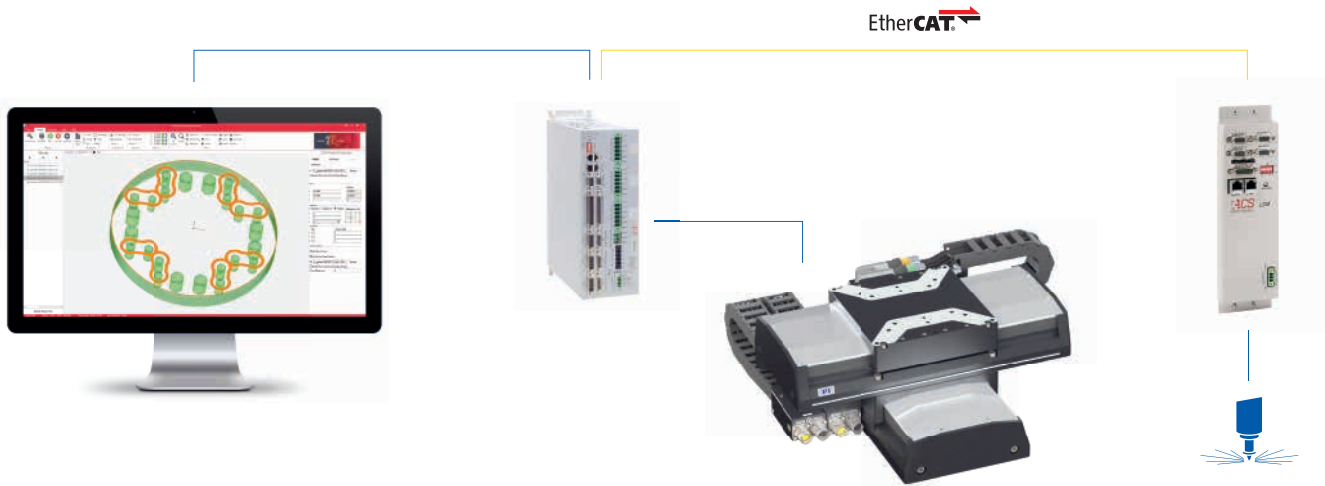

Key Features of the Control Solutions

- Modular hardware design
- EtherCAT®-based communications
- Open architecture for third party EtherCAT® drivers
- Universal support of multiple motor and feedback types
- HMI for CNC user operations

The EtherCAT®-based ACS motion controllers, drive modules and interfaces are ideally suited for multi-axis synchronized motion applications that need G code support with the capability to synchronized motion to laser control or 'Position - Event - Generator' (PEG). The advanced technology and highly modular system architecture of ACS ensures that the most demanding and complex applications are managed.

Modular Controller Architecture

ACS control distributed architecture is built of three tiers: The first tier is the host PC user interface which the motion system communications with. The devices on the second tier are EtherCAT® Motion Controllers and EtherCAT® Masters, >> p. 20.

The motion controller is responsible for communication with the host software and also manages everything related to profile generation, trajectory, macros, diagnostics, and so on.

The position commands are sent to the Universal Drive Modules on the third tier via an EtherCAT® real-time network. The universal drive modules on the third tier include the digital servo processor (DSP). It performs the servo positioning of the axes. The drive modules power and actuate the motors, handle the feedback devices, manage the I/Os, and analyze the sensor signals for closed-loop positioning control. The Control Modules combine in one housing the motion controller, drives, and the power supplies >> p. 20.



Customized Human Machine Interface (HMI):

A dedicated software to create a custom specific HMI is available. Machine developers, system integrators, and endusers can benefit because it results in higher machine performance and reduced expenditure on development.

ACS Motion Control Systems

Motion Controller – Control Modules – Drives – Interfaces

Smarter Motion and Positioning



- Functional safety
- Auto Tuning
- Operation as EtherCAT® Master
- Operation as 2nd EtherCAT® Master Motion Controller to be integrated in an existing PLC architecture
- Control algorithms, such as ServoBoost™ to optimize step-and-settle times
- Input shaping for vibration-free motion
- Extensive trigger functionality
- 3 Degrees-of-freedom compensation of positioning errors
- Yaw compensation for gantry solutions
- Proprietary and patented features such as NanoPWM

Interface: Laser Control Module (LCM)

ACS controllers are capable to create pulses based on feedback positions. Position-Event-Generator (PEG) allows positional events to be used to trigger an external device, for example a laser.

The EtherCAT® slave module LCM is specially developed for the laser industry. The LCM can control a laser source directly with synchronization to multi dimensional path motion, resulting in highest quality laser micro machining and optimal throughput.

It is also able to interface with a wide range of laser systems designed for processing and machining applications such as DPSS, CO₂, Q-switched, excimer, fiber, picosecond, femtosecond, and more.



LCM

- Digital pulse modulation for dynamic laser power control
- Pulse synchronization and laser gating (on/off) with motion path
- Flexible electrical interface: laser enable output, safety interlock input, fault input for robust safety implementation, general purpose programmable I/O
- User defined operational (window) zones
- Laser delay compensation
- Ability to combine control modes (fixed frequency, fixed pulse width, fixed duty cycle) to meet wide ranging application requirements
- Supports tickle mode
- Fixed and array based firing
- Supports absolute encoder positional information

As the module is connected to the EtherCAT® network it can be added when required for an application rather than choosing drive modules that have interfaces for synchronized firing. Therefore the system architecture is simpler to design and maintain.



Find more ACS motion controller and drive solutions on the PI website www.pi.us

ACS Motion Control Systems

Motion Controller – Control Modules – Drives – Interfaces

EtherCAT® Motion Controller



SPiiPlusEC Powerful Motion Controller and EtherCAT® Network Manager
up to 64 axes and thousands of I/O's



SPiiPlusES High Performance Multi-Axis Controller with Built-in EtherCAT®-to-EtherCAT® Bridge
up to 64 axes and thousands of I/O's

Control Module



SPiiPlusCMhp/ba 32-Axis EtherCAT® Master Control Module with 3 Built-in Drives
1 to 3 drives, 85 – 265 V-AC, up to 15/30 A

Universal Drive Modules



NPAPm Single/Dual Axis NanoPWM Drive with ±10 V Current Commutation Commands
1,2 drives, 12 – 100 V, up to 13.3/40 A



UDMsd EtherCAT® Dual/Quad Axis Drive Module
2, 4 drives, 12 – 48 V, up to 2.5/5 A



UDMpm EtherCAT® Single/Dual Axis Drive Module
1, 2 drives, 85 – 265 V, up to 7.5/15 A



UDMpa EtherCAT® Single/Dual Axis Drive Module
1, 2 drives, up to 100 V, 13.3/40 A



Technology: NanoPWM™

Recent developments in PWM technology have produced NanoPWM™ amplifiers. These offer 'linear' amplifier performance but without the limitations commonly associated with such amplification. The drawbacks of linear amplifiers are: heat generation, physically larger units, robustness of the electrical device, cost and the ability to deliver high powers when compared to PWM units. NanoPWM™ amplifiers like linear amplifiers have improved velocity and tracking control, an ability to optimize the use of high resolution feedback, and in-position stability is superior.

Integrated Motion Controller Solution

- 1, 2, & 4 motion axes
- Fully integrated closed-loop servo control, amplifier module, and power supplies
- For voice coil drives, DC motors and brushless 3-phase motors
- Quiet PWM drives
- Encoder inputs support sine/cosine and absolute



The A-81x motion controller series offers a fully integrated electronics solution with controller, drives, and power supplies in a compact 19-inch rack unit. The A-81x controllers are designed and optimized for PI stages that are equipped with direct drive linear and rotation servo motors, and high-resolution encoders. The A-81x motion controller features the state of the art ACS SPiiPlusEC motion controller and EtherCAT® master, and includes ServoBoost™ for up to eight axes of motion. ServoBoost™ provides better, more consistent servo performance that is insensitive to noise or changes in the system.

Online Product Finder

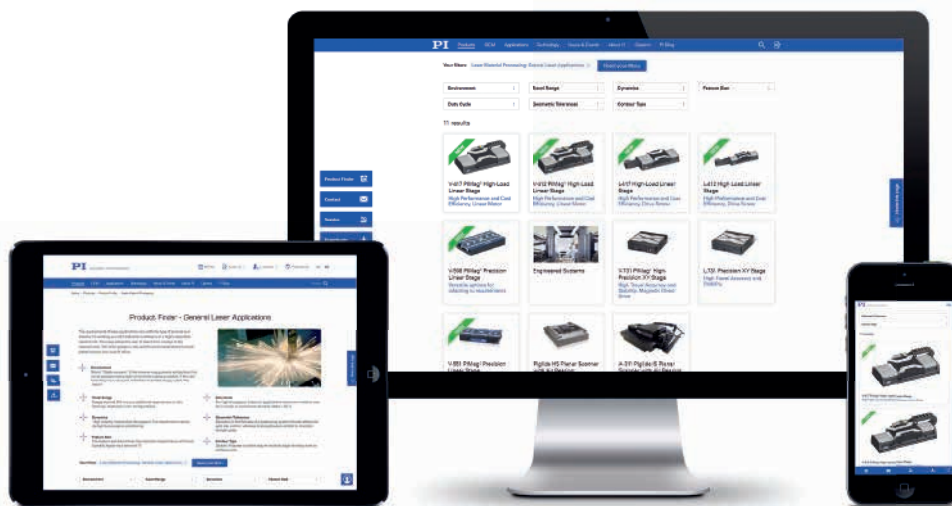

In addition to the brochure you can take advantage of the product finder on the PI website. It allows searching for a suitable automation solution for laser material processing according to different criteria such as environment, feature size, duty cycle, geometric tolerances and contour type.



Try out at www.pi-product-finder.com

From 1-off to Series:

OEM Users Benefit From Maximum Flexibility

PI serves both the research and industrial markets. The complete control over the design and manufacturing process provides our customers with significant competitive advantages. Optimized processes allow PI to deliver customized products in quantities up to several 100,000 units per year at low cost and right on time. The range of OEM products offered by the PI Group varies widely, ranging from “bare” actuators and sensors to highly integrated parallel-kinematic positioning systems. Evaluation of pre-production run samples, test procedures, production processes and quality management are all included in the development process.

Services

- Global account management: Close proximity to the customer thanks to international presence
- Risk assessment from design to delivery
- Depending on the task: From the drive to the turnkey system
- Copy exactly policy
- Preparation of internal and external certification
- Production of series of several 10,000 units in the shortest time
- Sustainable spare parts service
- Manufacturing and testing capacities from functional samples to mass production

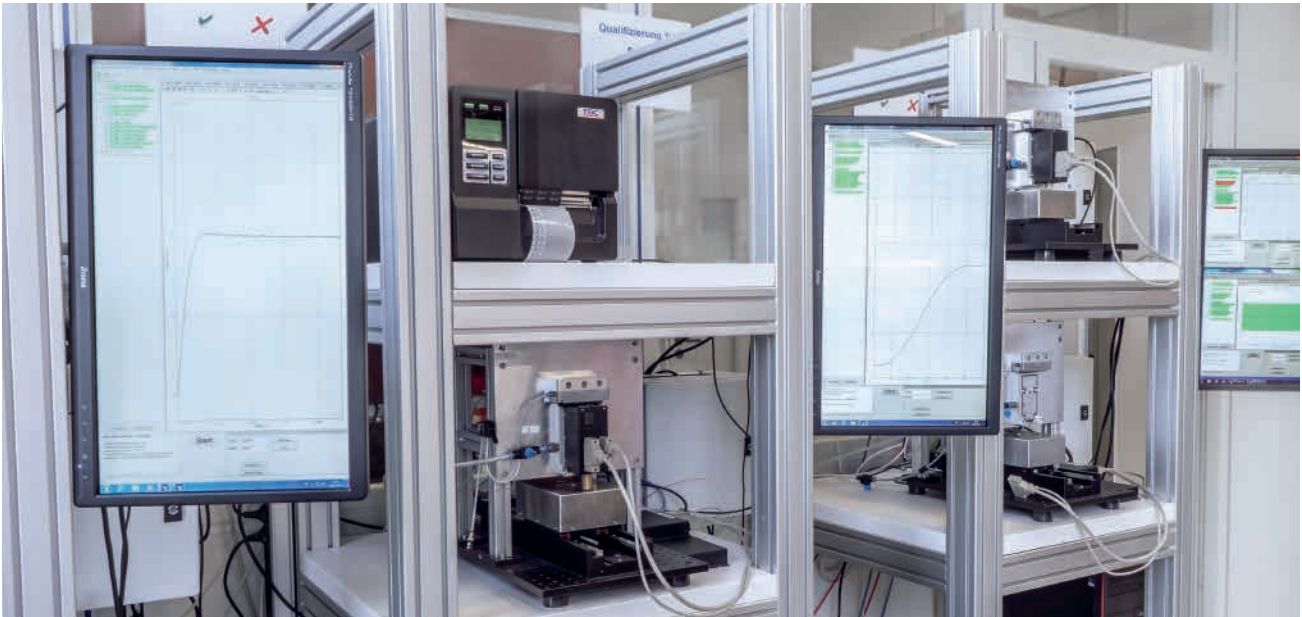

Standardized performance control with full documentation of individual measurement charts

Global Service and After-Sales

Tailored Service Packages for High-End Positioning Systems



On-site training is key to optimize and maximize the potential of new PI systems

Start-Up, User Training and Life Long Support

PI is dedicated to supporting its customers right from the initial consultation through to when a customer has purchased a PI system. Beyond that, PI's services division is committed to ensuring that every aspect of owning a PI system is catered for.

Global Coverage

Supported by 4 Global Service Hubs in Asia, China, Europe and USA, with field product specialists working from these hubs, PI is able to support all technologies and customer applications via this global services team.

PI's Standard On-Site Services

- Set up and Commissioning – On-site support to un-box, set-up and commission the PI system
- Training Program – User training on software and programming, through to optimization of system performance
- Maintenance Systems Health Check – Preventative maintenance to prolong the life of the motion device
- Support – Ongoing remote and on-site support to maximize system uptime and provide maintenance for the whole life of any system

Contracted Services

Customers subscribing to Contractual Support Services will receive commitment from PI to achieving agreed Service Levels. These include responding to the customer's first contact and providing remote technical support, through to response times for a PI expert to be on site, either to repair or replace a defective unit.

Extended Warranty

Most customer applications require PI's systems to be operational beyond the standard warranty period. Extending the warranty for additional year(s), is simply extending the customers peace of mind and PI's commitment that the product will not fail due to poor workmanship or faulty materials. Should a customer's system then fail due to these conditions, PI will cover the costs to repair or replace it.

Business Sectors

Industry and Research

Mechanical Engineering



Image: ICT-IMM

Vibrations of a piezo actuator reduce the processing times for high-precision micro-sized holes

- Processing, e.g. out-of-round turning with piezo actuators
- Precise positioning, even of high loads in six degrees of freedom
- Setup of testing systems

Basic Research

Creativity for research and development special designs for extreme ambient conditions such as UHV to 10^{-10} hPa, radiation or pronounced variations in temperature up the cryogenic range.



Image: Surface



Image: WITec GmbH

Microscopy

Position Lens or Specimen

Optical methods have been relying on PI positioning systems for years, e.g. for aligning optical systems or samples. Piezo actuators and motors are increasingly replacing conventional drive systems because they are more compact, more precise and faster. Other non-optical microscopic processes, such as SEM (scanning electron microscope) and AFM (atomic force microscope), use PI systems due to their high accuracy and dynamics.

Industrial Manufacturing and Quality Assurance, Optical Metrology

Inspection systems in the semiconductor industry utilize the performance features of PI systems, for example, for surface structures on semiconductors or flat-screen monitors with white light interferometry. PI piezo motor and actuator systems also help in the precise adjustment of wafers, imaging optics and the masks in semiconductor production.



Image: Polytec GmbH

Biotechnology/Life Sciences

Micro- and Nanopositioning Solutions

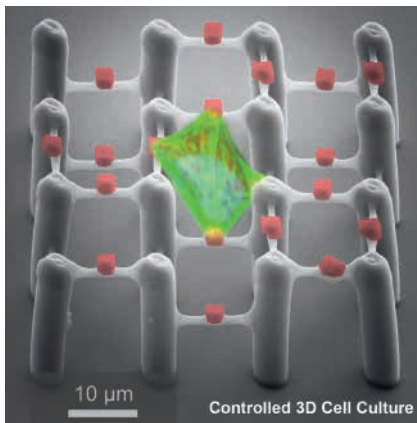

Image: B. Richter and M. Bastmeyer, Zoological Institute, Karlsruhe Institute of Technology (KIT)

Biotechnological applications using precise positioning system from PI are not only limited to typical optical procedures, such as focusing, or to moving and manipulation of samples in microscopy or in genome sequencers. In nano-dosing and microfluidics, drive system from PI allow the dosing of smallest volumes in procedures, such as PipeJet, or the design of finest structures by means of nanoimprint or 3D lithography.

Photonics Packaging, Silicon Photonics

Configuring and Testing Microchips



For manufacturing and testing components and systems, that are based on silicon photonics, precise positioning is crucial.

Automation: Automotive Industry

From the supply market to precision manufacturing in automotive production, PI offers suitable solutions such as six-axis hexapods. The integration of robotics into the automation environment is done by PI via Fieldbus interfaces.



The hexapod systems make it possible to reduce the installation area for the robotics considerably (Image: DYMACO GROUP)

Automation: Electronics Production

Tasks such as dosing of solder or setting solder points require just as much precision as a reliable positioning technique for positioning printed circuit boards or aligning a focusing system for inspection. PI also offers suitable technology for feeding wires during bonding or ultrasonic welding: Piezoelectric components, voice-coil actuators or high-precision planar scanners.

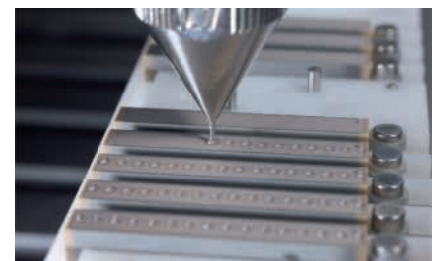

Valve control for applying solder points with piezoceramics

The PI Group Milestones

A Success Story

Well known for the high quality of its products, PI (Physik Instrumente) has been one of the leading players in the global market for precision positioning technology for many years. PI has been developing and manufacturing standard and OEM

products with piezo or motor drives for more than 40 years. In addition to four locations in Germany, the PI Group is represented internationally by fifteen sales and service subsidiaries. All of our customers worldwide can rely on this.

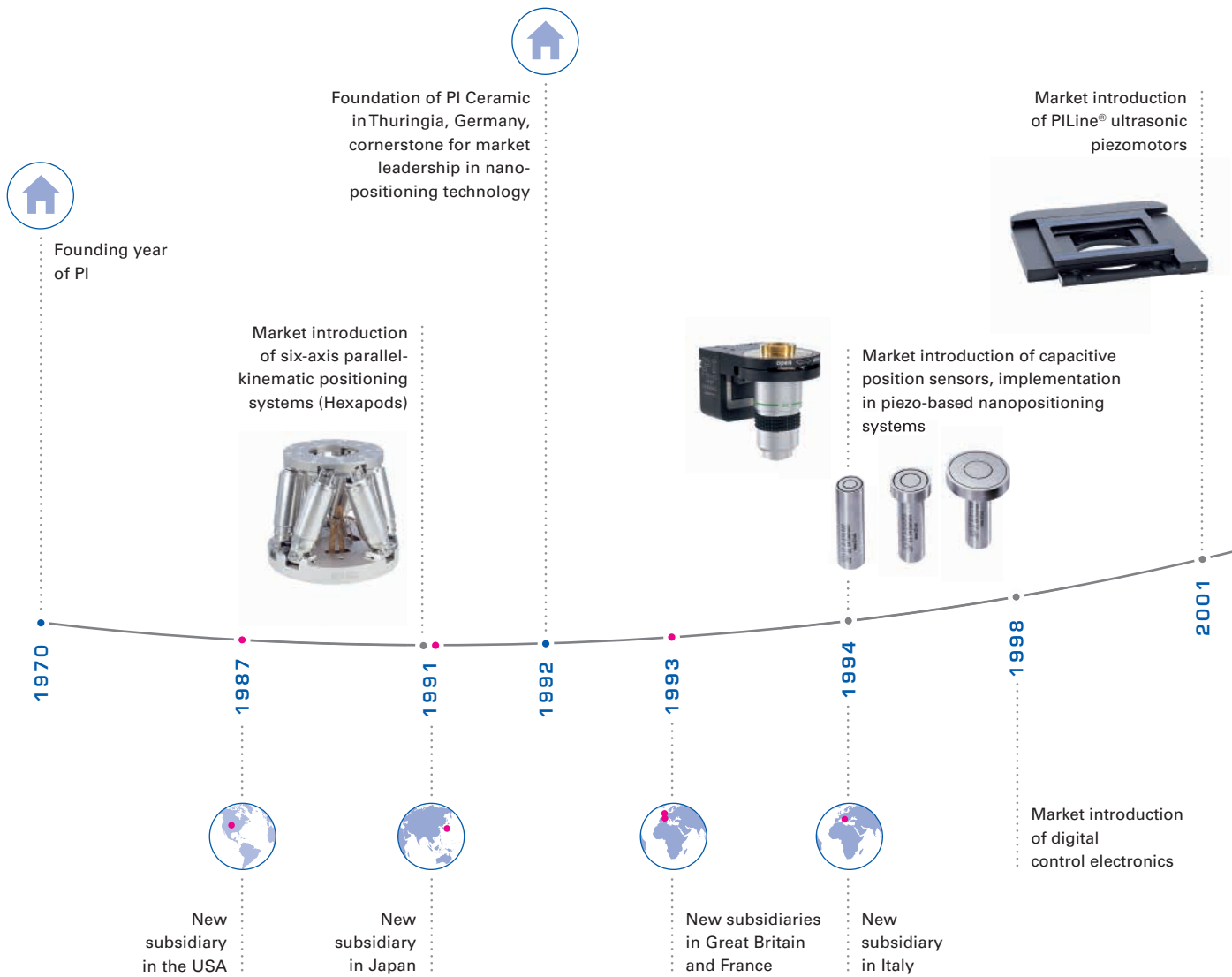

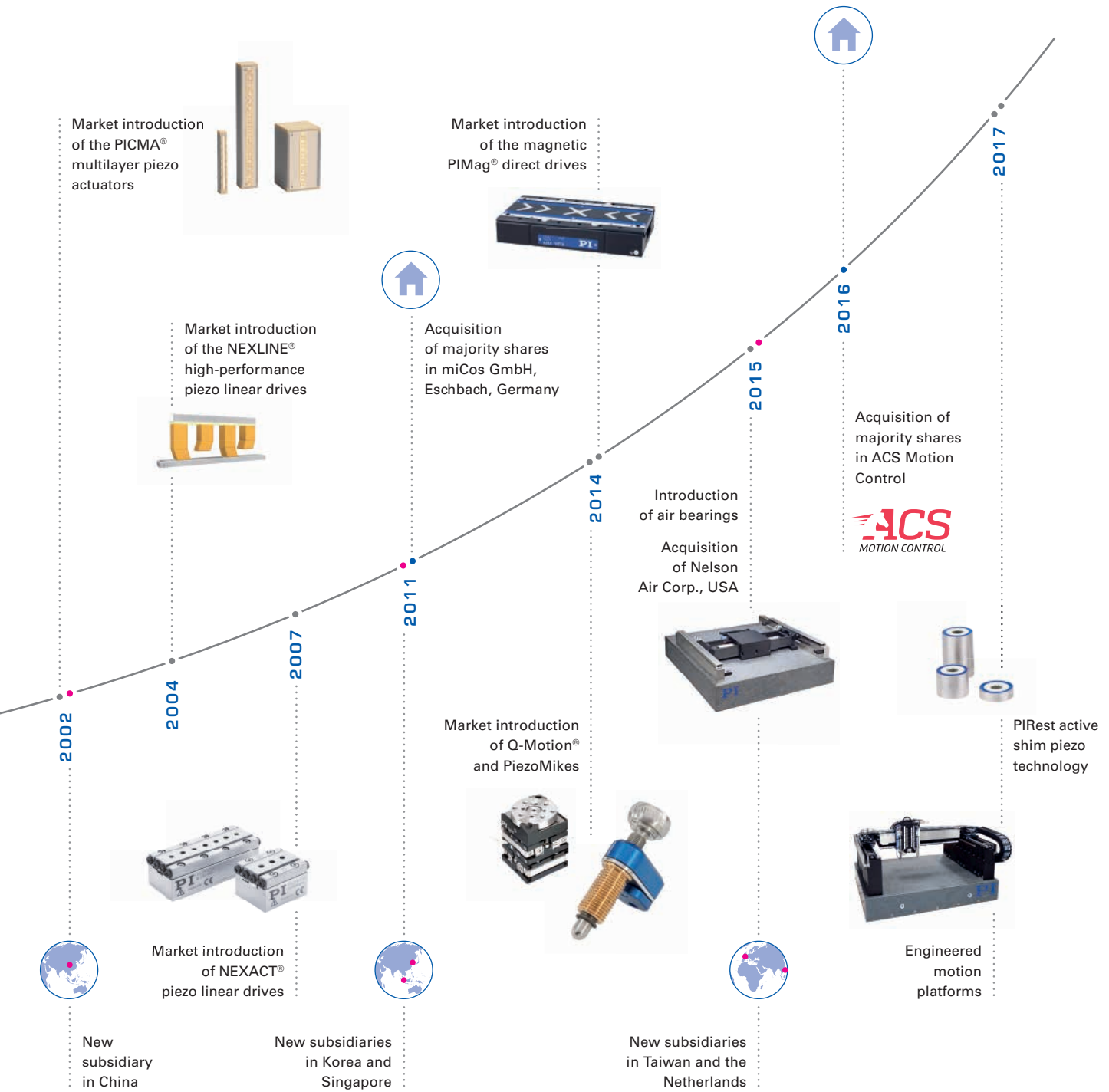



Headquarters

GERMANY

**Physik Instrumente (PI)
GmbH & Co. KG**
Auf der Roemerstrasse 1
76228 Karlsruhe
Phone +49 721 4846-0
Fax +49 721 4846-1019
info@pi.ws
www.pi.ws

PI miCos GmbH

Freiburger Strasse 30
79427 Eschbach
Phone +49 7634 5057-0
Fax +49 7634 5057-99
info@pimicos.com
www.pi.ws

PI Ceramic GmbH

Lindenstrasse
07589 Lederhose
Phone +49 36604 882-0
Fax +49 36604 882-4109
info@piceramic.com
www.piceramic.com



© Physik Instrumente (PI) GmbH & Co. KG

All contents, including texts, graphics, data etc., as well as their layout, are subject to copyright and other protective laws. Any copying, modification or redistribution in whole or in parts is subject to a written permission of PI.

Although the information in this document has been compiled with the greatest care, errors cannot be ruled out completely. Therefore, we cannot guarantee for the information being complete, correct and up to date. Illustrations may differ from the original and are not binding. PI reserves the right to supplement or change the information provided without prior notice.

Follow us on:



Subsidiaries

USA (East) & CANADA

PI (Physik Instrumente) L.P.
Auburn, MA 01501
www.pi-usa.us

USA (San Francisco Bay Area)

PI (Physik Instrumente) L.P.
Sausalito, CA 94965
www.pi-usa.us

ITALY

Physik Instrumente (PI) S. r. l.
Bresso
www.pionline.it

FRANCE

PI France SAS
Aix-en-Provence
www.pi.ws

JAPAN

PI Japan Co., Ltd.
Tokyo
www.pi-japan.jp

CHINA

**Physik Instrumente
(PI Shanghai) Co., Ltd.**
Shanghai
www.pi-china.cn

SOUTHEAST ASIA

**PI (Physik Instrumente)
Singapore LLP**
Singapore
www.pi-singapore.sg
For ID / MY / PH / SG / TH / VNM

KOREA

PI Korea Ltd.
Seoul
www.pikorea.co.kr

USA (West) & MEXICO

PI (Physik Instrumente) L.P.
Irvine, CA 92620
www.pi-usa.us

UK & IRELAND

PI (Physik Instrumente) Ltd.
Cranfield, Bedford
www.physikinstrumente.co.uk

NETHERLANDS

PI Benelux B.V.
Sint-Oedenrode
www.pi.ws/benelux

SPAIN

Micos Iberia S.L.
Vilanova i la Geltrú
www.pimicos.es

PI Japan Co., Ltd.

Osaka
www.pi-japan.jp

Physik Instrumente (PI Shanghai) Co., Ltd.

Beijing
www.pi-china.cn

TAIWAN

**Physik Instrumente (PI)
Taiwan Ltd.**
Taipei
www.pi-taiwan.com.tw