

New Linear Ultrasonic Micromotor for Precision Mechatronic Systems

K. Spanner, O. Vyshnevskyy, W. Wischnewskiy
Physik Instrumente (PI) GmbH & Co. KG, Karlsruhe, Germany

Abstract:

This paper presents a new design for a linear ultrasonic micromotor for precision positioning developed by Physik Instrumente (PI). The stator of the ultrasonic motor consists of a rectangular piezoceramic plate. Two sliders, bonded to a spring which presses them against the stator, move along guides integrated in the stator. These motors are characterized by their extremely simple construction. Two prototypes of the motors using a $9 \times 4 \times 1.5 \text{ mm}^3$ and a $16 \times 8 \times 1.5 \text{ mm}^3$ piezoceramic plate have been designed and tested. With an external position sensor and servo-controller, the motors can be driven to positions in the $0.1 \text{ }\mu\text{m}$ range. In open-loop mode, repeatable step size is in the micron range. Maximum speed of the motors is around 100 mm/s . In closed-loop mode, speeds in the millimeter per second range are possible. The design and operating characteristics of the prototypes in both open- and closed-loop modes are presented in this paper. To obtain the proper stator geometry, FEM software was used and the vibrational behavior of the system was analyzed with a 3D scanning vibrometer. The FEM simulations, as well as the results of the laser vibrometer measurements, will be presented as animations.

Keywords: piezomotor, PZT, ultrasonic motor, standing-wave, piezoelectric actuator, linear motor, piezo, non-magnetic, piezoceramic

Introduction

Piezoelectric ultrasonic motors (PUMs) have a number of advantages over electromagnetic motors. PUMs can achieve positioning accuracies in the range of several tens of nanometers. They hold their positions even when powered down and thus consume less energy. PUMs can be constructed with significantly fewer parts. The efficiency of electromagnetic motors falls as their dimensions are reduced, but that of PUMs stays virtually constant [1]. Linear electromagnetic motors are very difficult to design; in contrast linear PUMs are quite simple. Interest in PUMs is growing, especially for use as miniature drives in mass-produced consumer electronic products.

Miniaturized Piezoelectric Ultrasonic Motors

Physik Instrumente (PI) has been active in piezoelectric ultrasonic motor R&D for many years. Miniature PUMs have also been subject to investigation at PI. Several years ago PI developed a piezoelectric rotary traveling-wave motor with a stator measuring only $3 \times 3 \text{ mm}$ [2][3]. That motor uses what is known as the tangential-axial oscillation mode of the piezoelectric hollow cylinder. A traveling wave is set up in the stator with the help of three electrical signals which are 120° out of phase.

In addition to rotary ultrasonic motors, PI is also developing linear ultrasonic motors. The actuator

elements in the PILine[®] series employ asymmetric excitation of the (3,1) piezo-mode in a rectangular piezoceramic plate [4],[5],[6]. The actuators can be scaled at will and can be used for practically any mechatronics application. Figure 1 shows miniature rotary and linear piezomotors made at PI.

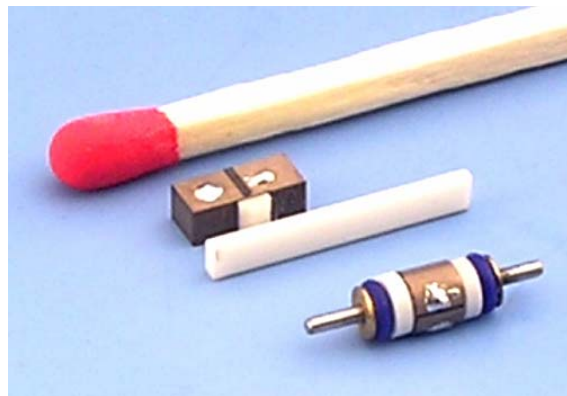

Fig. 1: Miniature piezoelectric ultrasonic motors from PI (match for size comparison)

The latest developments from PI are miniature linear PUMs with stator dimensions of $9 \times 4 \times 1.5 \text{ mm}^3$ and $16 \times 8 \times 1.5 \text{ mm}^3$.

Working Principle and Design of the New Ultrasonic Motor

Fig. 2 shows a CAD model of the newly developed ultrasonic motors [7]. These motors are of very simple design, consisting of two basic parts: the actuator (stator) and the sled (spring bonded to two sliders), the moving part of the motor. The actuator consists of a rectangular piezo-ceramic plate of size $L \times W \times 0.5L$ polarized in the *thickness* direction. The two large faces of the plate are covered by electrodes. On one (top, in Fig. 2) are the two exciter electrodes, each covering half of the surface. The “bottom” surface (not visible) has a single electrode that serves as a common drain.

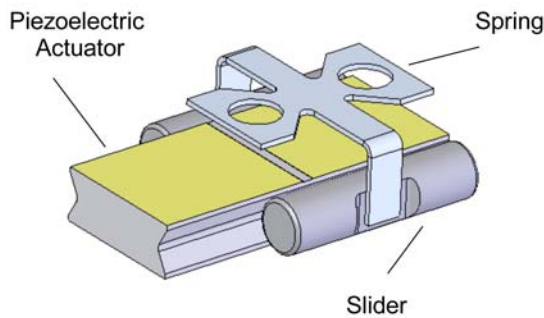

Fig. 2: CAD drawing of the newly developed miniature ultrasonic motor

The actuator plate has guide grooves cut in the long edges. The sled has two sliders which are pressed against the ceramic actuator by the integrated spring. The entire motor consists of the piezoceramic plate and the moving sled, guided along the integrated grooves in the plate.

Fig. 3 shows the $E(3,1)$ oscillation mode of a piezoceramic plate.

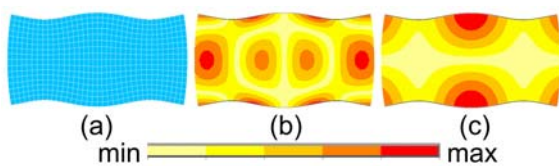

Fig. 3: $E(3,1)$ Modes in a rectangular piezoceramic plate (a) Deformation. (b) Length oscillation velocity distribution (c) height oscillation velocity distribution (FEM simulation).

The areas with the highest oscillation amplitudes in the height direction are on the long edges of the plate, at the exact center (Fig. 3c). The maxima for longitudinal oscillation are somewhat offset relative to the height maxima. The deformation of the plate is thus symmetrical relative to the length and width

symmetry planes of plate. The operating principle of the new ultrasonic motor is based upon asymmetric resonant excitation in the piezoceramic plate in an $E(3,1)$ mode. The asymmetric $E(3,1)$ excitation is accomplished using the split electrode. In so doing, the actuator is excited with a sine wave voltage applied to one of the excitation electrodes while the other floats. Under the influence of such an asymmetric $E(3,1)$ oscillation, the points of the guide grooves move along straight-line paths inclined at different angles relative to the surface. The motion amplitudes of the individual points differ as a function of position. There are even some locations, where the motion is in the opposite direction. The sliders, which are pressed into the guide grooves, receive tiny pushing impulses of varying amplitude from all the points they contact. The resultant force developed is one which moves the slider in the desired direction.

Fig. 4 shows the response of a piezoceramic plate to the asymmetric excitation used in this type of motor. Fig. 5 shows the distribution of the oscillation amplitudes in the longitudinal and height directions as well as the resulting point trajectories of points on the long edges of the plate.

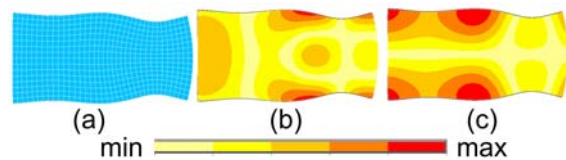

Fig. 4: $E(3,1)$ Modes in a rectangular piezoceramic plate (a) Deformation. (b) Length oscillation velocity distribution (c) height oscillation velocity distribution (FEM simulation).

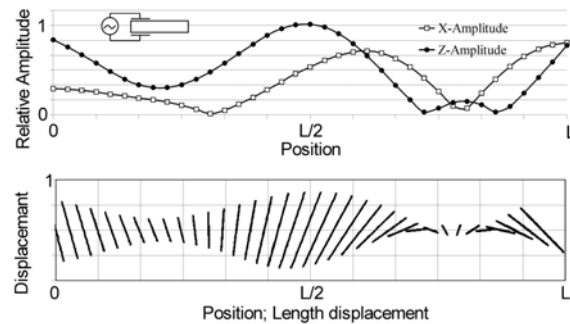

Fig. 5: Displacement Amplitudes (top); motion trajectories of Points on the plate edge. (bottom)

To change the direction of motion, the other electrode is excited and the first allowed to float. This changes the trajectory of the surface points by 90° , so that it impells the slider in the opposite direction.

Measurement with 3D Scanning Vibrometer

Finite Element Method (FEM) programs have proven to be essential tools for the development of ultrasonic motors. All the simulations, calculations and the optimization of ultrasonic motors were done with the help of ANSYS FEM software. Fig. 6 shows an FEM simulation of the stator of a 9 mm motor.

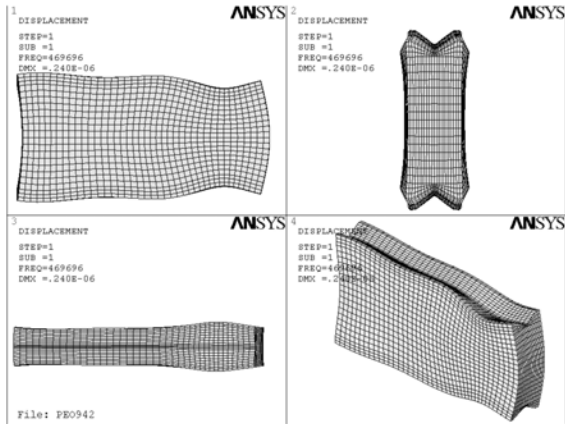

Fig. 6: FEM simulation of the stator of the newly developed ultrasonic motor

Fig. 7 shows the magnitude of the vector sum of the displacement vectors for each point on the surface.

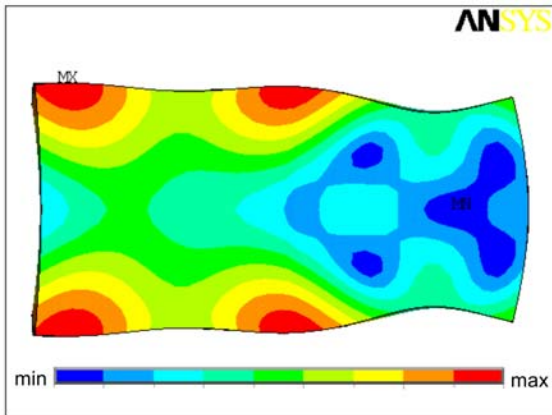

Fig. 7: Displacement vector sum (ANSYS)

To determine how well the calculated oscillation patterns and amplitudes correspond to those actually obtained, a number of measurements were performed. Such measurements can be made on a point-by-point basis using a two-dimensional piezoelectric sensor [2]. The simplest method, however, is to use a scanning laser vibrometer. Optical scanning of the actuator surface also

eliminates any influence the measuring system might have on the oscillation.

The PSV-300-3D laser measuring system from Polytec in Germany can scan an object and determine the vibratory motion of the individual surface points in three dimensions. Fig. 8 shows the results of vibration measurements of the stator of the 9 mm motor (without sliders); in the graphic the magnitude of the displacement vector (vector sum of all components) at each point is shown.

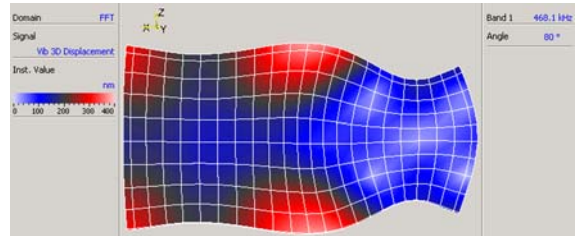

Fig. 8: Displacement vector sum (measured with laser vibrometer)

It shows excellent agreement with the calculated values.

The maximum oscillation amplitudes of the unloaded stator reach 400 nm; those of the stator with the sliders pressed against it, 200 nm.

Drive Circuitry for the Motor

Fig. 9 shows the impedance characteristic curve of the motor with and without the sliders. The resonant frequency used was 470 kHz. The fact that the resonant frequency is influenced by external conditions like temperature, makes necessary the development of electronics that automatically adjusts to the motor's resonant frequency.

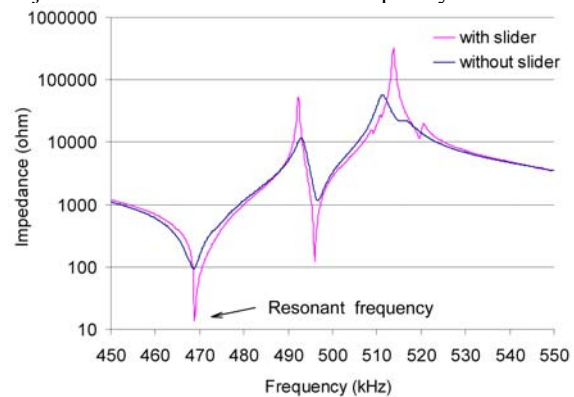

Fig. 9: Impedance curve of the 9-mm Motor

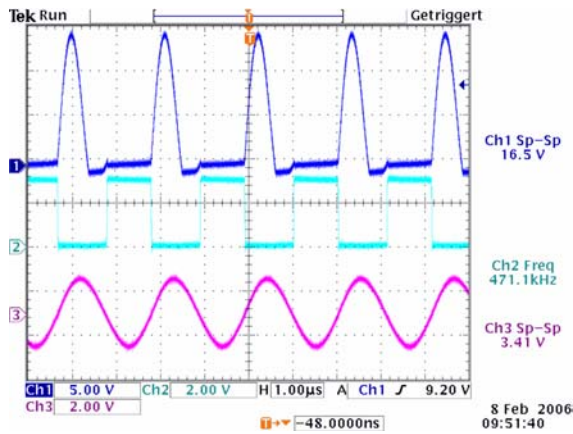

Fig. 10: Drive electronics signal. Ch1: voltage at the motor; Ch2: Signal at the switching transistor; Ch3: Current through the motor

The drive electronics can operate on a supply voltage starting at 2 V. With a 3 V supply, it can generate an output voltage with an amplitude of 15 V. With this voltage, the 9 mm motor can generate a maximum force of about 4 millinewtons (mN). The associated maximum speed (unloaded) is about 100 mm/s. With a voltage of 25 V, the 9 mm motors can generate maximum forces of up to 15 mN. The maximum speed then reaches a value of 180 mm/s.

Drive Characteristics of the New Micromotors

Fig. 11 shows two prototypes of the new ultrasonic motors with stators measuring $9 \times 4 \times 1.5 \text{ mm}^3$ and a $16 \times 8 \times 1.5 \text{ mm}^3$, respectively.

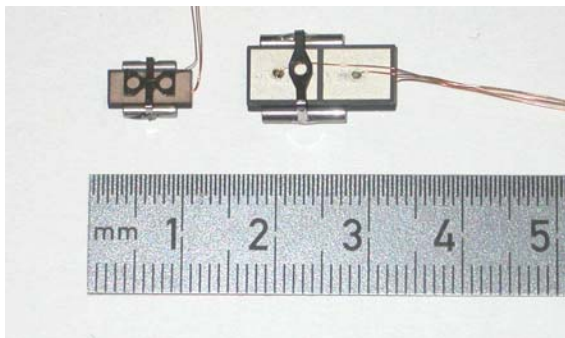

Fig. 11: Two prototypes of the motors with a $9 \times 4 \times 1.5 \text{ mm}^3$ and a $16 \times 8 \times 1.5 \text{ mm}^3$ piezoceramic plate as stator

The typical drive characteristics of the 9 mm motor are shown in Figs. 12-16. In open-loop, the 9 mm motor attains a speed of up to 100 mm/s. The smallest possible steps in open-loop mode are 100 nm. This corresponds to the resolution of the position measurement system used (Numerik Jena,

Germany). Figures 12 and 13 show the motor characteristic curves for open-loop operation.

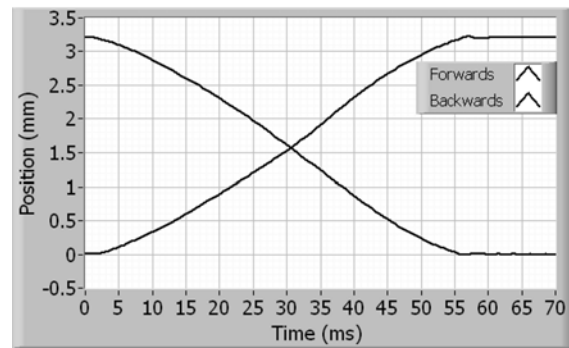

Fig. 12: Position vs. time characteristic curve of the motor with $9 \times 4 \times 1.5 \text{ mm}^3$ actuator (open-loop)

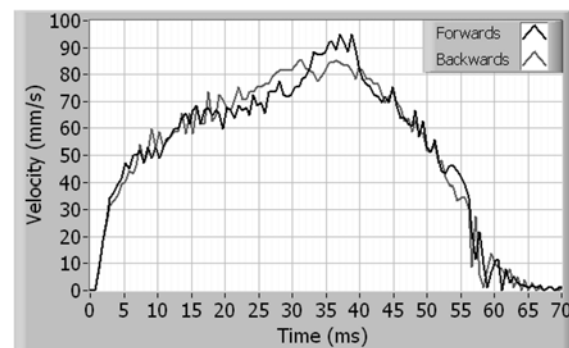

Fig. 13: Velocity vs. time characteristic curve of motor with $9 \times 4 \times 1.5 \text{ mm}^3$ actuator (open-loop)

Figure 14 shows the curve of the 9 mm motor in open-loop pulsed operation. The motor was given a pulse train of 1 ms ON pulses at a rate of 60 per second.

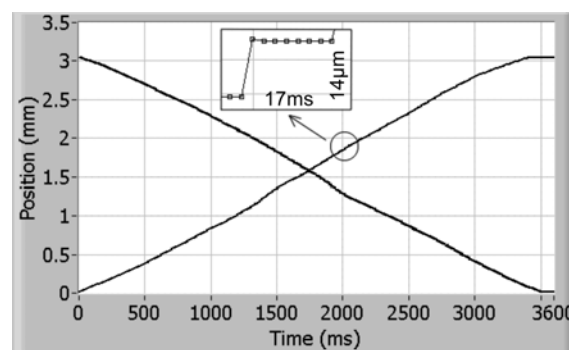

Fig. 14: Pulsed operation of the motor with $9 \times 4 \times 1.5 \text{ mm}$ actuator (open-loop)

Despite their extremely simple construction, these motors can be quite well servo-controlled. Closed-loop tests using a suitable motor controller, also from PI, in conjunction with an incremental optical position sensor attached to the motor, showed that

speeds up to several millimeters per second could easily be obtained. The minimal incremental motion in closed-loop was also measured at 100 nm. This corresponds to the resolution of the measurement system used. The time required for a $1\mu\text{m}$ step is typically less than 15 ms. Fig. 15 shows a $1\mu\text{m}$ step of the motor. Fig 16 shows the position characteristic curve of the motor in closed-loop operation with a speed of 10 mm/s.

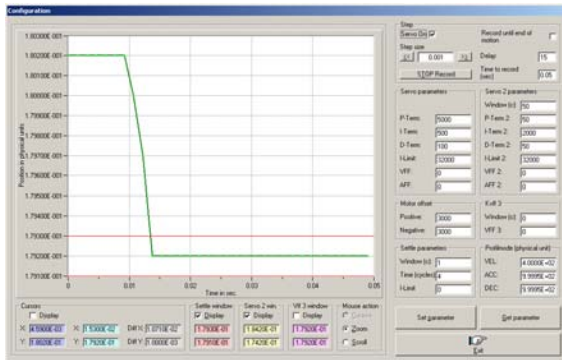

Fig. 15: $1\mu\text{m}$ step of the motor with $9\times 4\times 1.5\text{mm}^3$ actuator (closed-loop)

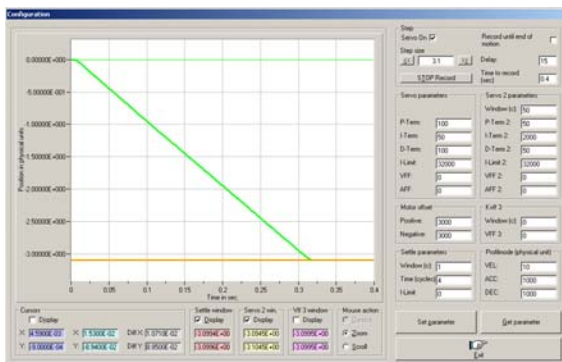

Fig. 16: Closed-loop operation of the motor with $9\times 4\times 1.5\text{mm}^3$ actuator with speed of 10 mm/s

Conclusions

A new type of piezoelectric ultrasonic motor has been developed which is most notably characterized by its very simple construction; it consists of a piezoceramic with integrated guide grooves and a slider. The dimensions can be easily reduced down to a few millimeters.

The travel ranges of these motors, while limited by the dimensions of the ceramic, are quite sufficient for many systems requiring only a few millimeters motion. Despite its simple construction, the motor is suitable for positioning tasks requiring accuracies in the submicron range. Endurance tests have shown that the motors can achieve 2 million cycles with no problems. The drive electronics can easily be implemented in ASIC technology.

References

- [1] K.Uchino, Proc. New Actuator 2004 (Bremen, June14-16), p.38 (2004)
- [2] Vyshnevskyy O, Kovalev S, Mehner J. Coupled tangential-axial resonant modes of piezoelectric hollow cylinders and their application in ultrasonic motors. IEEE Trans Ultrason Ferroelectr Freq Control. 2005 Jan;52(1):31-6.
- [3] O.Vyshnevskyy, W.Wischnewskij, Verfahren zum Betrieben eines piezoelektrischen Motors sowie piezoelektrischer Motor mit einem Stator in Form eines Hohlzylindrischen Oszillators, Deutsche Offenlegungsschrift DE 10314810A1, 05.08.2004
- [4] W.Wischnewskij, A. Wischnewskij, Piezoelektrischer Ultraschallmotor, Deutsche Offenlegungsschrift DE 102004024656A1, 08.12.2005
- [5] W. Wischnewskij, S. Kovalev, O. Vyshnevskyy, New Ultrasonic Piezoelectric Actuator for Nanopositioning. The 9th International Conference on New Actuators and the 3rd International Exhibition on Smart Actuators and Drive Systems, 2004, Bremen, Germany
- [6] O. Vyshnevskyy, S. Kovalev, W. Wischnewskij, A novel, single-mode piezoceramic plate actuator for ultrasonic linear motors. Published 20 January 2006 in *IEEE Trans Ultrason Ferroelectr Freq Control*, 52(11): 2047-53.
- [7] W.Wischnewskij, A. Wischnewskij, Linearer Ultraschall-Piezomotor, Deutsche Offenlegungsschrift DE 102004059429A1, 30.03.2006